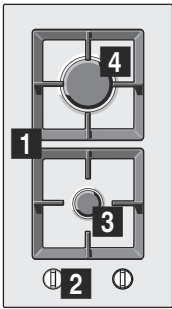

manual de instrucciones

3ETG63...
Βάση εστιών αερίου
Placa de cocción a gas
Placa de cozinhar a gás
Ankastre Gazli Ocak

[el] ΟΔΗΓΙΕΣ ΧΡΗΣΗΣ	3
[es] INSTRUCCIONES DE USO	12
[pt] INSTRUÇÕES DE SERVIÇO	21
[tr] KULLANMA KILAVUZU	30

3ETG632..

- 1** Σχάρες
- 2** Διακόπτες
- 3** Μέτριος καυστήρας έως 1,75 kW

- 1** Parrillas
- 2** Mandos
- 3** Quemador semi-rápido de hasta 1,75 kW

- 1** Grelhas
- 2** Comandos
- 3** Queimador semi-rápido de até 1,75 kW

- 1** Izgaralar
- 2** Kumanda düğmeleri
- 3** 1,75 kW'a kadar normal brülör

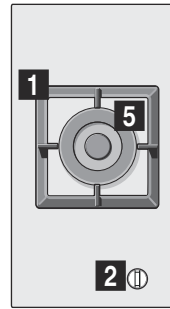
3ETG631..









- 4** Ταχύς καυστήρας έως 3 kW
- 5** Καυστήρας για Wok μέχρι και 4 kW

- 4** Quemador rápido de hasta 3 kW
- 5** Quemador wok de hasta 4 kW

- 4** Queimador rápido de até 3 kW
- 5** Queimador para wok com um máximo de 4 kW

- 4** 3 kW'a kadar büyük brülör
- 5** 4 kW'a kadar olan wok ocak gözü

Πίνακας περιεχομένων

	Αρμόζουσα χρήση	3
	Σημαντικές υποδείξεις ασφαλείας	4
	Γνωρίστε τη συσκευή.....	5
	Στοιχεία χειρισμού και καυστήρες	5
	Καυστήρες αερίου	6
	Χειροκίνητη ενεργοποίηση	6
	Αυτόματη ανάφλεξη	6
	Σύστημα ασφαλείας	6
	Σβήσιμο ενός καυστήρα	6
	Προειδοποιήσεις	6
	Πίνακες και συμβουλές	6
	Κατάλληλα σκεύη	6
	Υποδείξεις χρήσης	6
	Πίνακας μαγειρέματος	7
	Καθαρισμός και συντήρηση	9
	Καθαρισμός	9
	Συντήρηση	10
	Αντιμετώπιση βλαβών	10
	Υπηρεσία τεχνικής εξυπηρέτησης πελατών	11
	Όροι εγγύησης	11
	Προστασία περιβάλλοντος	11
	Απόσυρση σύμφωνα με τους κανόνες προστασίας του περιβάλλοντος	11

Αρμόζουσα χρήση

Διαβάστε προσεκτικά τις οδηγίες. Μόνο τότε θα μπορείτε να χειριστείτε τη συσκευή σας αποτελεσματικά και με ασφάλεια. Κρατήστε της οδηγίες χρήσης και εγκατάστασης, και παραδώστε τις οδηγίες αυτές μαζί με τη συσκευή σε κάποιο μελλοντικό ιδιοκτήτη.

Ο κατασκευαστής δεν φέρει καμία ευθύνη αν δεν ακολουθηθούν οι οδηγίες του παρόντος εγχειριδίου.

Οι εικόνες που υπάρχουν σ'αυτές τις οδηγίες είναι μόνο ενδεικτικές.

Μην βγάζετε τη συσκευή από το προστατευτικό περιτύλιγμα μέχρι τη στιγμή της εντοίχισης. Εάν παρατηρήσετε κάποια βλάβη στη συσκευή, μην τη συνδέετε. Επικοινωνήστε με το τεχνικό μας σέρβις.

Αυτή η συσκευή αντιστοιχεί στην κατηγορία 3, σύμφωνα με τον κανονισμό EN 30-1-1 για συσκευές αερίου: συσκευή εντοιχισμένη σε έπιπλο.

Πριν εγκαταστήσετε τη νέα βάση εστιών σας, βεβαιωθείτε ότι κάνετε την εγκατάσταση ακολουθώντας της οδηγίες συναρμολόγησης.

Δεν μπορεί να γίνει εγκατάσταση αυτής της συσκευής σε γιωτ ή τροχόσπιτα.

Η συσκευή αυτή πρέπει να χρησιμοποιείται μόνο σε αεριζόμενους χώρους.

Αυτή η συσκευή δεν προορίζεται για τη λειτουργία με έναν εξωτερικό χρονοδιακόπτη ή ένα τηλεχειριστήριο.

Όλες οι εργασίες εγκατάστασης, σύνδεσης, ρύθμισης και προσαρμογής σε άλλους τύπους αερίου θα πρέπει να γίνουν από εξουσιοδοτημένο τεχνικό, σύμφωνα με την ισχύουσα ρύθμιση και νομοθεσία, και τους κανονισμούς των τοπικών εταιριών διανομής ηλεκτρικού και αερίου. Ιδιαίτερη έμφαση πρέπει να δοθεί στις διατάξεις που εφαρμόζονται σχετικά με τον αερισμό.

Αυτή η συσκευή βγαίνει από το εργοστάσιο με προσαρμοσμένο το αέριο που ορίζεται στην ετικέτα χαρακτηριστικών. Εάν είναι απαραίτητο να το αλλάξετε, συμβουλευτείτε τις οδηγίες συναρμολόγησης. Συνίσταται να επικοινωνήσετε με το τεχνικό σέρβις για την προσαρμογή σε άλλους τύπους αερίου.

Αυτή η συσκευή έχει σχεδιαστεί μόνο για οικιακή χρήση, απαγορεύεται η εμπορική ή επαγγελματική χρήση της. Χρησιμοποιήστε τη συσκευή αποκλειστικά για μαγειρική, ποτέ ως θέρμανση. Η εγγύηση ισχύει μόνο εφόσον η συσκευή χρησιμοποιείται για τον λόγο που έχει σχεδιαστεί.

Αυτή η συσκευή προορίζεται για χρήση μέχρι ένα μέγιστο ύψος 2.000 μέτρων πάνω από την επιφάνεια της θάλασσας.

Μην αφήσετε τη συσκευή κατά τη διάρκεια της λειτουργίας χωρίς επιτήρηση.

Μην χρησιμοποιείτε καλύμματα ή προστατευτικά εμπόδια για παιδιά που δεν συνιστανται από τον κατασκευαστή της βάσης εστιών. Μπορεί να προκαλέσουν ατυχήματα, π.χ. λόγω υπερθέρμανσης, ανάφλεξης ή αποκόλλησης θραυσμάτων υλικών.

Αυτή η συσκευή επιτρέπεται να χρησιμοποιηθεί από παιδιά άνω των 8 ετών και από άτομα με μειωμένες φυσικές, αισθητήριες ή πνευματικές ικανότητες ή με ανεπαρκή εμπειρία ή γνώση, όταν επιτηρούνται ή εάν έχουν λάβει σχετικές οδηγίες για την ασφαλή χρήση της συσκευής από ένα άτομο που είναι υπεύθυνο για την ασφάλειά τους και έχουν κατανοήσει τους κινδύνους που μπορούν να προκύψουν.

Τα παιδιά δεν επιτρέπεται να παίζουν με τη συσκευή. Ο καθαρισμός και η συντήρηση από το χρήστη δεν επιτρέπεται να πραγματοποιηθούν από παιδιά, εκτός εάν είναι 8 ετών και άνω και επιτηρούνται.

Κρατάτε τα παιδιά που είναι κάτω των 8 ετών μακριά από τη συσκευή και το καλώδιο σύνδεσης.

Σημαντικές υποδείξεις ασφαλείας

Προειδοποίηση – Κίνδυνος κατάκαυσης!

Η συσσώρευση αερίου χωρίς να καίγεται σε ένα κλειστό χώρο εγκυμονεί κίνδυνο κατάκαυσης. Μην τοποθετείτε τη συσκευή κοντά σε ρεύμα αέρα. Οι καυστήρες μπορεί να σβήσουν. Διαβάστε με προσοχή τις οδηγίες και τις προειδοποιήσεις σχετικά με τη λειτουργία των καυστήρων αερίου.

Προειδοποίηση – Κίνδυνος δηλητηρίασης!

Η χρήση μιας συσκευής αερίου παράγει θερμότητα, υγρασία και προϊόντα καύσης στο μέρος που εγκαθίσταται. Διασφαλίστε ένα καλό εξαερισμό στο χώρο της κουζίνας, ειδικά ενώ λειτουργεί η βάση εστιών: να διατηρείτε ανοιχτά τα ανοίγματα φυσικού εξαερισμού, ή εγκαταστήστε μια συσκευή μηχανικού εξαερισμού (απορροφητήρας). Η έντονη και παρατεταμένη χρήση της συσκευής μπορεί να χρειάζεται ένα συμπληρωματικό ή ένα πιο αποτελεσματικό σύστημα εξαερισμού. ανοίξτε το παράθυρο ή αυξήστε την ισχύ του μηχανικού εξαερισμού.

Προειδοποίηση – Κίνδυνος εγκαυμάτων!

- Οι εστίες και τα κοντινά στοιχεία θερμαίνονται πολύ. Ποτέ μην αγγίζετε τις θερμές επιφάνειες. Μακριά από παιδιά κάτω των 8 χρονών.
- Εάν η μπουκάλια υγραερίου δεν στέκεται κάθετα, μπορεί να εισχωρήσει υγρό προπάνιο/βουτάνιο στη συσκευή. Σε αυτή την περίπτωση μπορούν να προκύψουν μεγάλες φλόγες στους καυστήρες. Τα εξαρτήματα μπορούν να υποστούν ζημιά και με την πάροδο του χρόνου να εμφανιστεί μια διαρροή, έτσι ώστε να εξέρχεται αέριο μη ελεγχόμενα. Και οι δύο περιπτώσεις μπορεί να οδηγήσουν σε τραυματισμούς. Χρησιμοποιείτε τις μπουκάλια υγραερίου πάντοτε σε κάθετη θέση.

Προειδοποίηση – Κίνδυνος πυρκαγιάς!

- Οι εστίες θερμαίνονται πολύ. Μην τοποθετείτε εύφλεκτα αντικείμενα πάνω στη βάση εστιών. Μην αποθηκεύετε αντικείμενα πάνω στη βάση εστιών.
- Μην αποθηκεύετε και μην χρησιμοποιείτε διαβρωτικές χημικές ουσίες, ατμούς, εύφλεκτα υλικά ή μη εδωδιμα προϊόντα, κάτω από αυτή την οικιακή συσκευή ή κοντά της.

- Τα υπερθερμαινόμενα λίπη και λάδια αναφλέγονται πολύ εύκολα. Μην απουσιάζετε ενώ ζεσταίνεται λίπος ή λάδι. Σε περίπτωση ανάφλεξης, μην σβήσετε τη φωτιά με νερό. Καλύψτε το σκεύος με ένα καπάκι για να συγκρατήσετε τη φωτιά και σβήστε την εστία.

⚠ Προειδοποίηση – Κίνδυνος τραυματισμού!

- Οι ρωγμές ή οι θραύσεις στη γυάλινη πλάκα είναι επικίνδυνες. Απενεργοποιήστε αμέσως όλους τους καυστήρες και κάθε ηλεκτρικό θερμαντικό στοιχείο. Τραβήξτε το φινι από την πρίζα ή κατεβάστε την ασφάλεια στο κιβώτιο των ασφαλειών. Κλείστε την παροχή αερίου. Μην ακουμπήσετε την επιφάνεια της συσκευής. Μην ενεργοποιείτε ποτέ μια χαλασμένη συσκευή. Καλέστε την υπηρεσία εξυπηρέτησης πελατών.
- Τα σκεύη που παρουσιάζουν βλάβες, δεν έχουν το κατάλληλο μέγεθος, προεξέχουν από τις άκρες της βάσης εστιών ή δεν είναι τοποθετημένα σωστά μπορεί να προκαλέσουν σοβαρούς τραυματισμούς. Διαβάστε με προσοχή τις συμβουλές και προειδοποιήσεις σχετικά με τα σκεύη μαγειρικής.
- Σε περίπτωση βλάβης, διακόψτε την ηλεκτρική τροφοδοσία και την παροχή αερίου στη συσκευή. Για την επισκευή, καλέστε το τεχνικό μας σέρβις.
- Μην τροποποιείτε το εσωτερικό της συσκευής. Σε περίπτωση ανάγκης καλέστε το τεχνικό μας σέρβις.
- Εάν κάποιος από τους διακόπτες δεν γυρνάει, μην βάζετε δύναμη. Καλέστε αμέσως το τεχνικό σέρβις για την επισκευή ή αντικατάσταση τους.

⚠ Προειδοποίηση – Κίνδυνος βραχυκυκλώματος!

- Μην χρησιμοποιείτε συσκευές καθαρισμού με ατμό για να καθαρίσετε τη συσκευή.
- Ρωγμές ή θραύσεις στη γυάλινη πλάκα μπορούν να προκαλέσουν ηλεκτροπληξία. Κατεβάστε την ασφάλεια στο κιβώτιο των ασφαλειών. Καλέστε την υπηρεσία τεχνικής εξυπηρέτησης πελατών.

Γνωρίστε τη συσκευή

Στην επισκόπηση των μοντέλων θα βρείτε τη συσκευή σας με τις βαθμίδες ισχύος των καυστήρων. → Σελίδα 2

Στοιχεία χειρισμού και καυστήρες

Σε κάθε διακόπτη χειρισμού είναι μαρκαρισμένος ο αντίστοιχος καυστήρας. Με τους διακόπτες χειρισμού μπορείτε να ρυθμίσετε, σύμφωνα με τις διάφορες θέσεις, την εκάστοτε απαραίτητη ισχύ μεταξύ των μέγιστων και των ελάχιστων τιμών. Μην δοκιμάσετε ποτέ, να περάσετε από τη θέση 0 απευθείας στη θέση 1 ή από τη θέση 1 στη θέση 0.

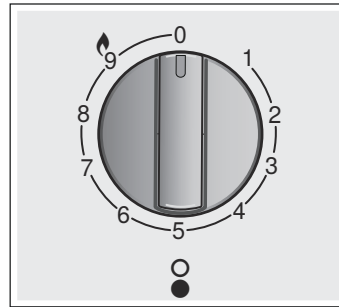

Ενδείξεις

	Καυστήρας ελεγχόμενος με το διακόπτη χειρισμού
0	Απενεργοποιημένος καυστήρας
9	Υψηλότερη βαθμίδα ισχύος και ηλεκτρική ανάφλεξη
1	Χαμηλότερη βαθμίδα ισχύος

Για την καλή λειτουργία της συσκευής είναι απαραίτητο να βεβαιωθείτε ότι οι σχάρες, καθώς και όλα τα κομμάτια, έχουν τοποθετηθεί σωστά. Μην ανταλλάζετε τα καπάκια των καυστήρων.

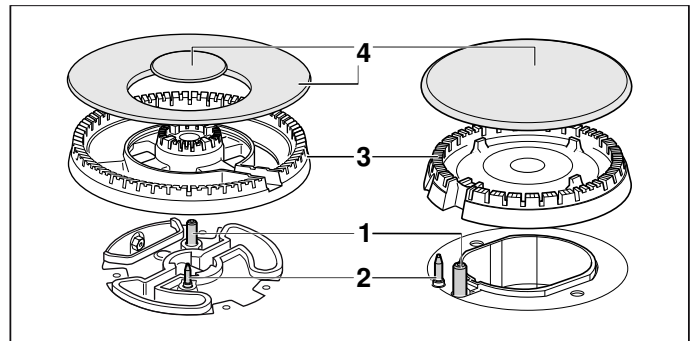

Στοιχεία

1	Αναφλεκτήρας
2	Θερμοστοιχείο
3	Κεφαλή καυστήρα
4	Καπάκι καυστήρα

Καυστήρες αερίου

Χειροκίνητη ενεργοποίηση

1. Πατήστε το διακόπτη χειρισμού του επιλεγμένου καυστήρα και γυρίστε το προς τα αριστερά, μέχρι την υψηλότερη βαθμίδα ισχύος.
2. Κρατήστε έναν αναφλεκτήρα ή μια φλόγα (αναπτήρας, σπρίτο κτλ.) κοντά στον καυστήρα.

Αυτόματη ανάφλεξη

Όταν η βάση εστιών διαθέτει μια αυτόματη ανάφλεξη (αναφλεκτήρες):

1. Πατήστε το διακόπτη χειρισμού του επιλεγμένου καυστήρα και γυρίστε το προς τα αριστερά, μέχρι την υψηλότερη βαθμίδα ισχύος. Κατά τη διάρκεια που κρατάτε πατημένο το διακόπτη χειρισμού, δημιουργούνται σ' όλους τους καυστήρες σπινθήρες. Ο καυστήρας ανάβει.
2. Αφήστε το διακόπτη χειρισμού ελεύθερο.
3. Γυρίστε το διακόπτη χειρισμού στην επιθυμητή θέση.

Εάν δεν πραγματοποιηθεί καμία ανάφλεξη, ενεργοποιήστε τον καυστήρα και επαναλάβετε τα βήματα που περιγράφονται προηγουμένως. Αυτή την φορά κρατήστε το διακόπτη χειρισμού περισσότερο χρόνο πατημένο (μέχρι και 10 δευτερόλεπτα).

Προειδοποίηση – Κίνδυνος εκρηκτικής ανάφλεξης!

Εάν ο καυστήρας δεν ανάψει μετά από 15 δευτερόλεπτα, κλείστε το διακόπτη χειρισμού και ανοίξτε την πόρτα ή το παρθέυρο του δωματίου. Περιμένετε το λιγότερο ένα λεπτό, προτού ανάψετε ξανά τον καυστήρα.

Υπόδειξη: Προσέξτε για πολύ μεγάλη καθαριότητα. Εάν οι αναφλεκτήρες είναι λερωμένοι, μπορεί να προκύψει μια ελαττωματική ανάφλεξη. Καθαρίζετε τακτικά τους αναφλεκτήρες με μια μικρή, μη μεταλλική βούρτσα. Προσέξτε, να μην ασκηθούν δυνατοί κραδασμοί στους αναφλεκτήρες.

Σύστημα ασφαλείας

Η βάση εστιών σας διαθέτει ένα σύστημα ασφαλείας (θερμοστοιχείο) που εμποδίζει τη διέλευση του αερίου αν οι καυστήρες σβήσουν τυχαία.

Για να βεβαιωθείτε ότι η συσκευή αυτή είναι ενεργή:

1. Ανάψτε τον καυστήρα φυσιολογικά.
2. Χωρίς να αφήσετε το διακόπτη, κρατήστε τον πατημένο σταθερά για 4 δευτερόλεπτα μετά το άναμμα της φλόγας.

Σβήσιμο ενός καυστήρα

Γυρίστε τον αντίστοιχο διακόπτη προς τα δεξιά μέχρι τη θέση 0.

Λίγα δευτερόλεπτα μετά το σβήσιμο του καυστήρα θα ακουστεί ένας ήχος (στεγνό χτύπημα). Δεν υπάρχει πρόβλημα, αυτό σημαίνει ότι η ασφάλεια έχει απενεργοποιηθεί.

Προειδοποιήσεις

Κατά τη λειτουργία του καυστήρα, είναι φυσιολογικό να ακουστεί ένα ελαφρύ σφύριγμα.

Κατά τις πρώτες χρήσεις, η εμφάνιση μυρωδιών είναι φυσιολογική. Δεν υφίσταται κανένας κίνδυνος ούτε κακή λειτουργία. Θα χαθούν με τον καιρό.

Είναι φυσιολογικό, η φλόγα να έχει χρώμα πορτοκαλί. Οφείλεται στη σκόνη που υπάρχει στο περιβάλλον, στην υπερχειλίση υγρών, κ.λπ.

Σε περίπτωση που οι φλόγες του καυστήρα σβήσουν τυχαία, κλείστε το διακόπτη λειτουργίας του καυστήρα και μην προσπαθείτε να τον ανάψετε για 1 λεπτό τουλάχιστον.

Πίνακες και συμβουλές

Κατάλληλα σκεύη

Καυστήρας	Ελάχιστη διάμετρος σκεύους	Μέγιστη διάμετρος σκεύους
Καυστήρας γουόκ	22 εκ.	- εκ.
Ταχύς καυστήρας	22 εκ.	26 εκ.
Μέτριος καυστήρας	14 εκ.	20 εκ.

Υποδείξεις χρήσης

Οι ακόλουθες προτάσεις θα σας βοηθήσουν να εξοικονομήσετε ενέργεια και να μην προκαλέσετε ζημιές στα σκεύη:

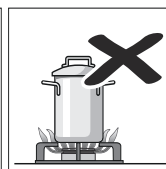
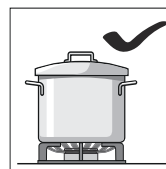

Χρησιμοποιήστε σκεύη κατάλληλου μεγέθους για κάθε καυστήρα.

Να μη χρησιμοποιείτε μικρά σκεύη πάνω σε μεγάλους καυστήρες. Η φλόγα δεν πρέπει να αγγίζει τα πλευρικά τοιχώματα του σκεύους.

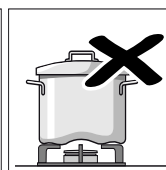
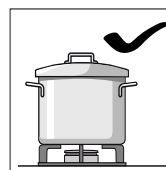

Μην χρησιμοποιείτε παραμορφωμένα σκεύη, τα οποία είναι ασταθή πάνω στην εστία. Τα σκεύη μπορεί να γείρουν.

Χρησιμοποιήστε μόνο σκεύη με βάση επίπεδη και λεία.

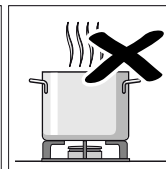
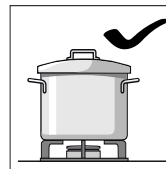

Μην μαγειρεύετε χωρίς καπάκι ή με μισοσκεπασμένο σκεύος. Χάνεται μέρος της ενέργειας.

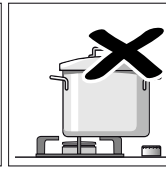
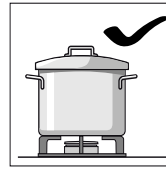

Τοποθετήστε το σκεύος καλά κεντραρισμένο πάνω στον καυστήρα. Σε αντίθετη περίπτωση μπορεί να γείρει. Μην τοποθετείτε μεγάλα σκεύη στους καυστήρες που βρίσκονται κοντά στους διακόπτες. Μπορεί να προκληθεί βλάβη λόγω υπερβολικής θερμοκρασίας.

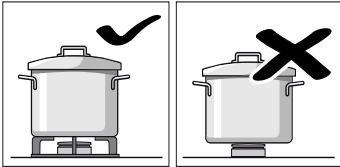

Τοποθετήστε τα σκεύη πάνω στις σχάρες, ποτέ απευθείας επάνω στον καυστήρα. Βεβαιωθείτε πριν από τη χρήση ότι οι σχάρες και τα καλύμματα των καυστήρων είναι καλά τοποθετημένα. Χειριστείτε τα σκεύη με προσοχή πάνω στη βάση εστιών. Μην χτυπάτε τη βάση εστιών, και μην τοποθετείτε πάνω της υπέρβαρα αντικείμενα.

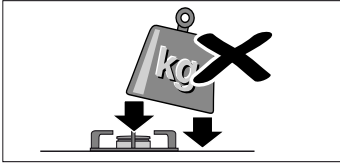

Πίνακας μαγειρέματος

Ο παρακάτω πίνακας περιέχει τις ιδανικές βαθμίδες μαγειρέματος και τους ιδανικούς χρόνους μαγειρέματος για διάφορα φαγητά. Τα στοιχεία είναι τιμές αναφοράς για τέσσερα άτομα.

Οι χρόνοι μαγειρέματος και οι βαθμίδες μαγειρέματος εξαρτώνται από το είδος, το βάρος και την ποιότητα των φαγητών καθώς και από το υλικό των μαγειρικών σκευών. Για αυτό μπορούν να υπάρξουν αποκλίσεις.

Χρησιμοποιείτε πάντοτε ένα αντίστοιχα μεγάλο μαγειρικό σκεύος και τοποθετήστε το στο κέντρο πάνω στον καυστήρα. Δείτε τις πληροφορίες για τη διάμετρο του μαγειρικού σκεύους. → "Κατάλληλα σκεύη"

Πληροφορίες σχετικά με τον πίνακα

Η παρασκευή κάθε φαγητού αποτελείται από ένα ή δύο βήματα. Κάθε βήμα περιέχει πληροφορίες για τα εξής:

- Μέθοδος μαγειρέματος
- Βαθμίδα μαγειρέματος
- Διάρκεια σε λεπτά

Αναφερόμενες στον πίνακα μέθοδοι μαγειρέματος

- Βράσιμο
- Συνέχιση μαγειρέματος
- Δημιουργία πίεσης στη χύτρα ταχύτητας
- Διατήρηση της πίεσης στη χύτρα ταχύτητας
- Δυνατό σοτάρισμα
- Ελαφρό σοτάρισμα
- Λιώσιμο
- * Χωρίς καπάκι
- ** Συνεχές ανακάτεμα

Υπόδειξη: Αυτά τα σύμβολα δε θα τα βρείτε πάνω στη συσκευή. Χρησιμεύουν ως προσανατολισμός για τις διάφορες μεθόδους μαγειρέματος.

Στον πίνακα θα βρείτε στοιχεία για την παρασκευή φαγητών σε διαφορετικούς καυστήρες. Η συνηθισμένη επιλογή είναι ο πρώτος καυστήρας. Στην επισκόπηση των μοντέλων περιγράφονται όλοι οι καυστήρες της βάσης εστιών. → Σελίδα 2

Παράδειγμα:

Φαγητό Καυστήρας	Συνολικός χρόνος σε λεπτά	Βήμα 1			Βήμα 2		
Σούπες, σούπες κρέμα							
Ψαρόσουπα							
Γρήγορα	12-17		8	7-9		1 5-8	
Κανονικά	17-22		8	11-13		1 6-9	
Wok	10-15		9	6-8		4 4-7	

Αυτό το παράδειγμα δείχνει την παρασκευή της ψαρόσουπας με τη βοήθεια του γρήγορου καυστήρα, του κανονικού καυστήρα και του καυστήρα Wok.

Με το γρήγορο καυστήρα (συνιστούμενη επιλογή) ανέρχεται ο συνολικός χρόνος μαγειρέματος μεταξύ 12 και 17 λεπτών.

- Βήμα 1: Ανάβρασμα Χρησιμοποιήστε τη βαθμίδα μαγειρέματος 8 για 7-9 λεπτά.
- Βήμα 2: Συνέχιση μαγειρέματος Αλλάξτε στη βαθμίδα μαγειρέματος 1 για 5-8 λεπτά.

Εάν χρησιμοποιήσετε έναν από τους άλλους προτεινόμενους καυστήρες, προχωρήστε με τον ίδιο τρόπο.

Φαγητό Καυστήρας	Συνολικός χρόνος σε λεπτά	Βήμα 1			Βήμα 2		
Σούπες, σούπες κρέμα							
Ψαρόσουπα							
Γρήγορα	12-17		8	7-9		1 5-8	
Κανονικά	17-22		8	11-13		1 6-9	
Wok	10-15		9	6-8		4 4-7	
Κρέμα κολοκυθιού, σούπα μπορς							
Γρήγορα	30-35		9	10-12		5 20-23	
Κανονικά	45-50		9	15-17		6 30-33	
Wok	25-30		9	8-10		2 17-20	
Μινεστρόνε (σούπα λαχανικών)							
Γρήγορα	47-52		9	10-12		5 37-40	
Κανονικά	57-62		9	10-12		6 47-50	
Wok	43-48		8	8-10		3 35-38	
Ζυμαρικά και ρύζι							
Σπαγκέτι							
Γρήγορα	18-22		* 9	8-10		6 10-12	
Κανονικά	20-24		* 9	10-12		7 10-12	
Wok	18-22		* 8	8-10		6 10-12	
Ρύζι:							
Γρήγορα	17-22		9	5-7		2 12-15	
Κανονικά	18-23		9	7-9		6 11-14	
Wok	15-20		8	4-6		2 11-14	
Ραβιόλια							
Γρήγορα	9-14		9	4-6		6 5-8	
Κανονικά	17-22		8	12-14		8 5-8	
Wok	10-15		8	5-7		8 5-8	

Φαγητό Καυστήρας	Συνολικός χρόνος σε λεπτά	Βήμα 1			Βήμα 2		
Λαχανικά και όσπρια							
Βραστές πατάτες (πουρέ, πατατοσαλάτα)							
Γρήγορα	23-28		9	8-10		5	15-18
Κανονικά	25-30		9	10-12		6	15-18
Wok	25-30		7	11-13		5	14-17
Χούμους (ρεβίθια πουρέ)							
Γρήγορα	50-55		9	10-12		4	40-43
Κανονικά	52-57		9	12-14		5	40-43
Wok	47-52		7	10-12		5	37-40
Φακές							
Γρήγορα	40-45		9	8-10		9	32-35
Κανονικά	50-55		9	18-20		6	32-35
Wok	45-50		6	20-22		4	25-28
Τηγανητά στη φριτέζα λαχανικά							
Γρήγορα	12-17		* 7	6-8		* 6	6-9
Κανονικά	15-20		* 8	8-10		* 7	7-10
Wok	11-16		* 7	6-8		* 5	5-8
Σταριασμένα φρέσκα λαχανικά**							
Wok	6-8		* 9	6-8			
Γρήγορα	6-8		* 9	6-8			
Τηγανητές πατάτες							
Wok	15-20		* 7	15-20			
Γρήγορα	15-20		* 9	15-20			
Κανονικά	25-30		* 9	25-30			
Αυγά							
Shakshuka							
Κανονικά	15-20		9	10-12		4	5-8
Γρήγορα	13-18		8	7-9		3	6-9
Wok	15-20		6	11-13		4	4-7
Ομελέτα (1 μερίδα)							
Κανονικά	3-5		* 8	3-5			
Γρήγορα	2-4		* 9	2-4			
Wok	2-4		* 5	2-4			
Ισπανική τортίγια							
Γρήγορα	25-30		* 9	25-30			
Wok	18-23		* 9	18-23			
Σάλτσες							
Σάλτσα μπεσαμέλ**							
Κανονικά	10-15		* 5	2-4		* 5	8-11
Wok	3-8		* 5	1-2		* 5	2-6
Γρήγορα	3-8		* 5	1-2		* 5	2-6
Σάλτσα με μπλε τυρί**							
Κανονικά	3-5		* 7	3-5			
Γρήγορα	3-5		* 5	3-5			

Φαγητό Καυστήρας	Συνολικός χρόνος σε λεπτά	Βήμα 1			Βήμα 2		
Σάλτσα ναπολιτάνα							
Κανονικά	18-23		* 6	2-4		* 4	16-19
Wok	13-18		* 7	1-3		* 5	12-15
Γρήγορα	15-20		* 8	1-3		* 6	14-17
Σάλτσα καρμπονάρα							
Κανονικά	10-15		* 6	5-7		* 3	5-8
Γρήγορα	8-13		* 5	4-6		* 3	4-7
Ψάρι							
Μπακαλιάρος αλά ρωμαϊκά							
Γρήγορα	5-10		* 8	5-10			
Κανονικά	8-13		* 9	8-13			
Wok	4-9		* 6	4-9			
Τηγανητός σολομός							
Γρήγορα	5-10		* 7	2-4		1	3-6
Κανονικά	5-10		* 8	2-4		1	3-6
Wok	7-12		* 8	2-4		1	5-8
Μύδια							
Γρήγορα	5-7		9	5-7			
Wok	4-6		9	4-6			
Κανονικά	10-12		9	10-12			
Κρέας							
Στήθος πάπιας (1 κομμάτι)							
Κανονικά	6-8		* 7	6-8			
Γρήγορα	9-11		* 7	9-11			
Wok	6-8		* 5	6-8			
Βοδινό φιλέτο στρογκανόφ							
Γρήγορα	8-13		* 9	8-13			
Wok	5-10		* 8	5-10			
Κανονικά	12-17		* 9	12-17			
Σνίτσελ κοτόπουλου (8 φιλέτα από στήθος κοτόπουλου)							
Γρήγορα	7-12		* 9	2-4		* 6	5-8
Wok	7-12		* 9	2-4		* 6	5-8
Κανονικά	7-12		* 9	7-12			
Κιμάς (πατέ κρέατος, κεφτεδάκια, σάλτσα μπολονέζε)							
Γρήγορα	15-20		* 8	15-20			
Κανονικά	20-25		* 9	20-25			
Wok	15-20		* 6	15-20			
Έτοιμα προϊόντα							
Καταψυγμένες κροκέτες (16 κομμάτια)							
Καταψυγμένα φετάκια ψαριού πανέ (12 κομμάτια)							
Γρήγορα	6-10		8	6-10			
Wok	5-9		8	5-9			
Κανονικά	8-12		8	8-12			

Φαγητό Καυστήρας	Συνολικός χρόνος σε λεπτά	Βήμα 1			Βήμα 2		
							
Ψητά λουκάνικα (12 κομμάτια)							
Γρήγορα	5-10		9	1-3		7	4-7
Κανονικά	7-12		9	7-12			
Wok	5-10		9	1-3		7	4-7
Βραστά λουκάνικα (12 κομμάτια)							
Κανονικά	8-13		9	8-13			
Wok	9-14		4	9-14			
Γρήγορα	7-12		7	7-12			
Χάμπουργκερ (4 κομμάτια)							
Γρήγορα	4-9		9	1-3		7	3-6
Wok	4-9		9	1-3		7	3-6
Κανονικά	5-10		9	1-3		8	4-7
Κατεψυγμένα λαχανικά**							
Γρήγορα	7-12		9	7-12			
Wok	5-10		9	5-10			
Κανονικά	12-17		9	12-17			
Πίτσα (20 cm διάμετρος)							
Wok	4-8		1	4-8			
Γρήγορα	16-20		1	16-20			
Κανονικά	20-25		1	20-25			
Επιδόρπια							
Πουτίγκα ρυζιού**							
Κανονικά	30-35		8	9-11		4	21-24
Wok	35-40		7	11-13		1	24-27
Σοκολάτα γάλακτος							
Κανονικά	16-20		1	16-20			
Κρέπες (4 κομμάτια)							
Γρήγορα	17-22		7	1-3		5	16-19
Wok	8-13		7	1-3		4	7-10
Κανονικά	20-25		8	1-3		6	19-22
Πουτίγκα ψωμιού							
Γρήγορα	25-30		9	10-12		6	15-18
Wok	23-28		9	8-10		7	15-18
Κανονικά	27-32		9	10-12		7	17-20
Ισπανική πουτίγκα**							
Γρήγορα	3-8		5	3-8			
Κανονικά	8-13		5	8-13			
Wok	3-8		2	3-8			
Κέικ (σε μπεν μαρι)							
Γρήγορα	35-40		9	35-40			
Wok	40-45		9	40-45			
Κανονικά	45-50		9	45-50			

Συμβουλές μαγειρέματος

- Χρησιμοποιείτε για την παρασκευή σουπών κρέμας και οσπρίων μια χύτρα ταχύτητας. Ο χρόνος μαγειρέματος μειώνεται σημαντικά. Εάν χρησιμοποιήσετε μια χύτρα ταχύτητας, ακολουθήστε τις οδηγίες του κατασκευαστή.
- Τοποθετείτε κατά το μαγείρεμα πατατών και ρυζιού πάντοτε ένα καπάκι. Έτσι ο χρόνος μαγειρέματος γίνεται σημαντικά μικρότερος.
- Στα τηγανητά φαγητά πρέπει πρώτα να ζεστάνετε το λάδι. Μόλις αρχίσετε με το τηγάνισμα, κρατήστε τη θερμοκρασία σταθερή, προσαρμόζοντας σε περίπτωση που χρειάζεται τη βαθμίδα μαγειρέματος. Στην παρασκευή περισσότερων μεριδών περιμένετε, μέχρι να επιτευχθεί ξανά η θερμοκρασία μαγειρέματος. Γυρίζετε τακτικά τα φαγητά.



Καθαρισμός και συντήρηση

Καθαρισμός

Μόλις κρυώσει η συσκευή, καθαρίστε την με ένα σφουγγάρι, νερό και σαπούνι.

Μετά από κάθε χρήση, μόλις κρυώσει ο καυστήρας καθαρίστε την επιφάνεια των αντίστοιχων εξαρτημάτων του. Εάν αφήσετε υπολείμματα (επαναψημένα τρόφιμα, στάγματα λίπους, κτλ.), ακόμη και αν είναι λίγα, θα σχηματίσουν μια κρούστα στην επιφάνεια και θα είναι πολύ δύσκολο να τα καθαρίσετε. Είναι απαραίτητο να είναι καθαρές οι οπές και οι εγκοπές, για μια καλή φλόγα.

Η μετακίνηση κάποιων οσκειών μπορεί να αφήσει μεταλλικά υπολείμματα πάνω στις σχάρες.

Καθαρίστε με σαπουνόνερο και τρίψτε με μια μη μεταλλική βούρτσα τους καυστήρες και τις σχάρες.

Εάν οι σχάρες διαθέτουν ελαστικούς τάκους, προσέξτε κατά τον καθαρισμό τους. Οι τάκοι μπορεί να βγουν και η σχάρα μπορεί να χαράξει τη βάση εστιών.

Να στεγνώνετε πάντα καλά τους καυστήρες και τις σχάρες. Εάν υπάρχουν σταγόνες νερού ή υγρές περιοχές κατά την έναρξη του μαγειρέματος, μπορεί να φθείρει το σμάλτο.

Μετά από τον καθαρισμό και το στέγνωμα των καυστήρων, βεβαιωθείτε ότι τα καλύμματα είναι καλά τοποθετημένα πάνω στο διαχυτήρα.

Προσοχή!

- Για τον καθαρισμό της συσκευής μην αφαιρέσετε τα στοιχεία χειρισμού. Εισερχόμενη υγρασία μπορεί να προκαλέσει ζημιά στη συσκευή.
- Μην χρησιμοποιείτε συσκευές για καθαριότητα με ατμό. Μπορεί να φθείρει τη βάση εστιών.
- Μην χρησιμοποιείτε κανένα προϊόν καθαρισμού, σφουγγαράκια από σύρμα, αιχμηρά αντικείμενα, μαχαίρια κ.λπ. για να απομακρύνεται τα σκληρυσμένα υπολείμματα φαγητού από τη βάση εστιών.
- Μην χρησιμοποιείτε μαχαίρια, ξύστρες ή παρόμοια για να καθαρίσετε το σύνολο κρυστάλλου με τα πλαίσια των καυστήρων, μεταλλικά πλαίσια ή του πίνακες από κρύσταλλο εάν υπάρχουν.

Συντήρηση

Καθαρίστε άμεσα τα υγρά που υπερχειλίζουν. Έτσι θα εμποδίσετε τα υπολείμματα φαγητού να κολλήσουν και θα εξοικονομήσετε περιττές προσπάθειες.

Μην σύρετε πάνω στο γυαλί τα σκεύη γιατί μπορεί να το γρατζουνίσουν. Ομοίως, αποφύγετε την πτώση σκληρών ή αιχμηρών αντικειμένων πάνω στον κρύσταλλο. Μη χτυπάτε κανένα από τα άκρα της βάσης εστίων.

Οι κόκκοι άμμου (που προέρχονται, για παράδειγμα, από τον καθαρισμό λαχανικών και κηπευτικών) χαράζουν την επιφάνεια του κρύσταλλου.

Αν έχει χυθεί λιωμένη ζάχαρη και τρόφιμα με υψηλή περιεκτικότητα σε ζάχαρη, θα πρέπει να καθαρίσετε αμέσως την εστία με τη βοήθεια της ξύστρας για κρύσταλλο.

? Αντιμετώπιση βλαβών

Σε ορισμένες περιπτώσεις οι τυχόν εμφανιζόμενες βλάβες μπορούν να αντιμετωπιστούν εύκολα. Πριν καλέσετε την υπηρεσία τεχνικής εξυπηρέτησης πελατών, προσέξτε τις ακόλουθες υποδείξεις:

Πρόβλημα	Πιθανή αιτία	Λύση
Βλάβη του ηλεκτρικού ρεύματος στο γενικό πίνακα.	Ελαττωματική ασφάλεια.	Ελέγξτε στο γενικό πίνακα με τις ασφάλειες εάν η ασφάλεια είναι καμένη και αλλάξτε την.
	Το αυτόματο ή ένα διαφορικό έχει πηδήξει.	Ελέγξτε το γενικό πίνακα διανομής μήπως έχει πηδήξει το αυτόματο ή το διαφορικό.
Δεν λειτουργεί το αυτόματο άναμμα.	Μπορεί να υπάρχουν υπολείμματα τροφών ή καθαρισμού ανάμεσα στον σπινθηριστές και στους καυστήρες.	Το κενό ανάμεσα στον σπινθηριστή και στον καυστήρα πρέπει να είναι καθαρό.
	Οι καυστήρες είναι υγρά.	Στεγνώστε με προσοχή τα καπάκια του καυστήρα.
	Τα καπάκια των καυστήρων δεν είναι καλά τοποθετημένα.	Ελέγξτε αν τα καπάκια είναι καλά τοποθετημένα.
	Η συσκευή δεν έχει γείωση, δεν είναι σωστή η σύνδεση ή η γείωση έχει πρόβλημα.	Επικοινωνήστε με τον ηλεκτρολόγο εγκατάστασης.
Η φλόγα του καυστήρα δεν είναι ομοιόμορφη.	Τα καπάκια των καυστήρων δεν είναι καλά τοποθετημένα.	Τοποθετήστε σωστά τα κομμάτια πάνω στον ανάλογο καυστήρα.
	Οι εγκοπές του καυστήρα είναι βρώμικες.	Καθαρίστε τις εγκοπές του καυστήρα.
Η ροή αερίου δεν φαίνεται κανονική, ή δεν βγαίνει αέριο.	Η ροή αερίου είναι κλειστή από τα ενδιάμεσα κλειδιά.	Ανοίξτε τα πιθανά ενδιάμεσα κλειδιά.
	Εάν το αέριο προέρχεται από φιάλη, ελέγξτε αν είναι άδεια.	Αλλάξτε τη φιάλη.
Η κουζίνα μυρίζει αέριο.	Κάποιος κρουνός είναι ανοιχτός.	Κλείστε τους κρουνούς.
	Μη σωστή εφαρμογή της φιάλης.	Ελέγξτε αν η σύνδεση είναι σωστή.
	Πιθανή διαρροή αερίου.	Κλείστε το γενικό κλειδί αερίου, αερίστε το χώρο και ειδοποιήστε αμέσως έναν εξουσιοδοτημένο τεχνικό εγκατάστασης για να ελέγξει και να πιστοποιήσει την εγκατάσταση. Μην χρησιμοποιείτε τη συσκευή μέχρι να βεβαιωθείτε ότι δεν υπάρχει καμία διαρροή αερίου στην εγκατάσταση ή στη συσκευή.
Ο καυστήρας σβήνει αμέσως μόλις αφήσετε το διακόπτη.	Δεν πατήσατε για αρκετό χρονικό διάστημα το διακόπτη.	Μόλις ανάψετε τον καυστήρα, κρατήστε πατημένο το διακόπτη για μερικά ακόμα δευτερόλεπτα.
	Οι εγκοπές του καυστήρα είναι βρώμικες.	Καθαρίστε τις εγκοπές του καυστήρα.

Υπηρεσία τεχνικής εξυπηρέτησης πελατών

Εάν επικοινωνήσετε με το Τεχνικό μας Σέρβις, θα πρέπει να γνωρίζετε τον αριθμό του προϊόντος (E-Nr.) και τον αριθμό παραγωγής (FD) της συσκευής. Αυτή η πληροφορία υπάρχει στην ετικέτα χαρακτηριστικών, που βρίσκεται στο κάτω μέρος της βάσης εστιών, και στην ετικέτα του εγχειριδίου.

Τα στοιχεία επικοινωνίας όλων των χωρών θα τα βρείτε στον πίνακα Υπηρεσίες τεχνικής εξυπηρέτησης πελατών που παραδίδεται μαζί.

Εντολή επισκευής και συμβουλές σε περίπτωση βλάβης

GR 18 182
Αστική χρέωση

Εμπιστευθείτε την εμπειρία του κατασκευαστή. Έτσι εξασφαλίζετε, ότι η επισκευή γίνεται από εκπαιδευμένους τεχνικούς του σέρβις, που είναι εξοπλισμένοι με τα γνήσια ανταλλακτικά για τη συσκευή σας.

Όροι εγγύησης

Αν, αντίθετα από τις προσδοκίες μας, η συσκευή παρουσιάσει κάποια βλάβη ή δεν πληροί τις αναμενόμενες απαιτήσεις ποιότητας, σας παρακαλούμε να μας ενημερώσετε το συντομότερο δυνατόν. Για να είναι έγκυρη η εγγύηση σας, η συσκευή δεν πρέπει να έχει υποστεί παρέμβαση ή να έχει υποβληθεί σε κακή χρήση.

Οι όροι εγγύησης που εφαρμόζονται είναι αυτοί που ορίζονται από την εκπροσώπηση της εταιρίας μας στη χώρα όπου έγινε η αγορά. Μπορείτε να ζητήσετε περισσότερες πληροφορίες στο κατάστημα αγοράς. Είναι αναγκαίο να παρουσιάσετε την απόδειξη αγοράς για να χρησιμοποιήσετε την εγγύηση.

Διατήρηση του δικαιώματος για τροποποιήσεις.

Προστασία περιβάλλοντος

Εάν πάνω στην πινακίδα τύπου της συσκευής βρίσκεται το σύμβολο , προσέξτε τις ακόλουθες υποδείξεις.

Απόσυρση σύμφωνα με τους κανόνες προστασίας του περιβάλλοντος

Αποσύρετε τη συσκευασία σύμφωνα με τους κανόνες προστασίας του περιβάλλοντος.











Αυτή η συσκευή χαρακτηρίζεται σύμφωνα με την ευρωπαϊκή οδηγία 2012/19/ΕΕ περί ηλεκτρικών και ηλεκτρονικών συσκευών (waste electrical and electronic equipment - WEEE).

Η οδηγία προκαθορίζει τα πλαίσια για μια απόσυρση και αξιοποίηση των παλιών συσκευών με ισχύ σ' όλη την ΕΕ.

Το περιτύλιγμα της συσκευής σας κατασκευάστηκε από τα απαιτούμενα υλικά για την εξασφάλιση της αποτελεσματικής προστασίας κατά τη μεταφορά. Αυτά τα υλικά είναι εξ ολοκλήρου ανακυκλώσιμα, μειώνοντας έτσι την επίπτωση στο περιβάλλον. Σας καλούμε να συνεισφέρετε και εσείς στη διατήρηση του περιβάλλοντος, ακολουθώντας τις παρακάτω συμβουλές:

- πετάξτε τη συσκευασία στον κατάλληλο κάδο ανακύκλωσης,
- απενεργοποιήστε τη συσκευή, πριν την απόρριψη της. Συμβουλευτείτε την τοπική σας αυτοδιοίκηση για την πιο κοντινή τοποθεσία του κέντρου διαλογής ανακυκλώσιμων υλικών και παραδώστε εκεί τη συσκευή σας,
- μην πετάτε το χρησιμοποιημένο λάδι στον νεροχύτη. Φυλάξτε το σε ένα κλειστό δοχείο και παραδώστε το σε κάποιο σημείο διαλογής ή, εάν δεν υπάρχει, σε έναν κάδο σκουπιδιών (πολύ πιθανόν να καταλήξει σε κάποιο ελεγχόμενο σκουπιδότοπο, ίσως δεν είναι η καλύτερη λύση, αλλά τουλάχιστον αποφεύγουμε τη μόλυνση του νερού).

Índice

	Uso correcto del aparato.....	12
	Indicaciones de seguridad importantes	13
	Presentación del aparato	14
	Mandos y quemadores	14
	Quemadores de gas.....	15
	Encendido manual	15
	Encendido automático	15
	Sistema de seguridad	15
	Apagar un quemador	15
	Advertencias	15
	Tablas y consejos	15
	Recipientes apropiados	15
	Advertencias de uso	15
	Tabla de cocción	16
	Limpieza y cuidados del aparato	18
	Limpieza	18
	Mantenimiento	19
	¿Qué hacer en caso de avería?	19
	Servicio de Asistencia Técnica	20
	Condiciones de garantía	20
	Protección del medio ambiente	20
	Eliminación de residuos respetuosa con el medio ambiente	20

Uso correcto del aparato

Lea atentamente estas instrucciones. Solo entonces podrá manejar su aparato de manera efectiva y segura. Conserve las instrucciones de uso e instalación y entréguelas con el aparato si este cambia de dueño.

El fabricante queda exento de toda responsabilidad si no se cumplen las disposiciones de este manual.

Las imágenes representadas en estas instrucciones tienen carácter orientativo.

No saque el aparato del embalaje protector hasta el momento del encastre. Si observa algún daño en el aparato, no lo conecte. Póngase en contacto con nuestro Servicio Técnico.

Este aparato corresponde a la clase 3, según la norma EN 30-1-1 para aparatos a gas: aparato encastrado en un mueble.

Antes de instalar su nueva placa de cocción asegúrese de que la instalación se realiza siguiendo las instrucciones de montaje.

Este aparato no puede ser instalado en yates o caravanas.

Este aparato se debe utilizar únicamente en lugares suficientemente ventilados.

Este aparato no está previsto para el funcionamiento con un reloj temporizador externo o un mando a distancia.

Todos los trabajos de instalación, conexión, regulación y adaptación a otros tipos de gas deben ser realizados por un técnico autorizado, respetando toda la normativa y legislación aplicables y las prescripciones de las compañías locales proveedoras de gas y electricidad. Se pondrá especial atención a las disposiciones aplicables en cuanto a la ventilación.

Este aparato sale de fábrica adaptado al tipo de gas que indica la placa de características. Si fuera necesario cambiarlo, consulte las instrucciones de montaje. Se recomienda llamar a nuestro Servicio Técnico para la adaptación a otros tipos de gas.

Este aparato ha sido diseñado solo para uso doméstico, no está permitido su uso comercial o profesional. Utilice el aparato únicamente para cocinar, nunca como

calefacción. La garantía únicamente tendrá validez en caso de que se respete el uso para el que fue diseñado.

Este aparato está previsto para ser utilizado a una altura máxima de 2.000 metros sobre el nivel del mar.

Durante el funcionamiento, el aparato no debe dejarse sin vigilancia.

No use tapas o barreras de protección para niños que no estén recomendadas por el fabricante de la placa de cocción. Pueden provocar accidentes, p. ej. debido al sobrecalentamiento, ignición o desprendimiento de fragmentos de materiales.

Este aparato puede ser utilizado por niños a partir de 8 años y por personas con limitaciones físicas, sensoriales o psíquicas, o que carezcan de experiencia y conocimientos, siempre y cuando sea bajo la supervisión de una persona responsable de su seguridad o que le haya instruido en el uso correcto del aparato siendo consciente de los daños que se pudieran ocasionar.

No dejar que los niños jueguen con el aparato. La limpieza y el mantenimiento rutinario no deben encomendarse a los niños a menos que sean mayores de 8 años y lo hagan bajo supervisión.

Mantener los niños menores de 8 años alejados del aparato y del cable de conexión.

Indicaciones de seguridad importantes

Advertencia – ¡Peligro de deflagración!

La acumulación de gas sin quemar en un recinto cerrado conlleva peligro de deflagración. No someta el aparato a corrientes de aire. Los quemadores podrían apagarse. Lea atentamente las instrucciones y advertencias relativas al funcionamiento de los quemadores de gas.

Advertencia – ¡Peligro de intoxicación!

El uso de un aparato de cocción a gas produce calor, humedad y productos de combustión en el local donde está instalado. Asegure una buena ventilación de la cocina, especialmente mientras la placa de cocción esté en funcionamiento: mantenga abiertos los orificios de ventilación natural o instale un dispositivo de ventilación mecánica (campana extractora). La utilización intensa y prolongada del aparato puede necesitar una ventilación complementaria o más eficaz: abra una ventana o aumente la potencia de la ventilación mecánica.

Advertencia – ¡Peligro de quemaduras!

- Las zonas de cocción y adyacentes se calientan mucho. No toque nunca las superficies calientes. Mantenga alejados a los niños menores de 8 años.
- Si la botella de gas líquido no está en posición vertical, el propano/butano líquido puede llegar al interior del aparato, por lo que puede causar llamas vivas en los quemadores. Con el tiempo, los componentes pueden dañarse y perder estanqueidad, de modo que puede escaparse gas. Ambos casos pueden producir quemaduras. Utilizar botellas de gas líquido siempre en posición vertical.

Advertencia – ¡Peligro de incendio!

- Las zonas de cocción se calientan mucho. No coloque objetos inflamables sobre la placa de cocción. No almacene objetos sobre la placa de cocción.
- No almacene ni utilice productos químicos corrosivos, vapores, materiales inflamables ni productos no alimenticios debajo de este electrodoméstico ni cerca de él.

- Las grasas o aceites sobrecalentados se inflaman fácilmente. No se ausente mientras caliente grasa o aceite. Si se inflaman, no apague el fuego con agua. Cubra el recipiente con una tapa para sofocar el fuego y desconecte la zona de cocción.

⚠ Advertencia – ¡Peligro de lesiones!

- Las fisuras o roturas en la placa de cristal conllevan peligro. Apague inmediatamente todos los quemadores y cualquier elemento eléctrico de calentamiento. Desenchufe el aparato de la red o desconecte el fusible en la caja de fusibles. Corte la alimentación de gas. No toque la superficie del aparato. Nunca conecte un aparato defectuoso. Avise al servicio de asistencia técnica.
- Los recipientes que presenten daños, tengan un tamaño inadecuado, rebasen los bordes de la placa de cocción o estén mal situados pueden provocar lesiones graves. Observe los consejos y advertencias relativos a los recipientes de cocinado.
- En caso de avería, corte la alimentación eléctrica y de gas del aparato. Para la reparación, llame a nuestro servicio técnico.
- No manipule el interior del aparato. Si fuera necesario, llame a nuestro servicio técnico.
- Si alguno de los mandos no se puede girar, no lo fuerce. Llame inmediatamente al servicio técnico para que proceda a su reparación o sustitución.

⚠ Advertencia – ¡Peligro de descarga eléctrica!

- No utilice máquinas de limpieza a vapor para limpiar el aparato.
- Las fisuras o roturas en la placa de cristal conllevan riesgo de electrocución. Desconectar el fusible de la caja de fusibles. Avisar al Servicio de Asistencia Técnica.

Presentación del aparato

En el resumen de los modelos encontrará una vista general de su aparato así como la potencia de los quemadores. → *Página 2*

Mandos y quemadores

Cada mando de accionamiento tiene señalado el quemador que controla. Los mandos le permiten regular la potencia que necesite, según las distintas posiciones, entre los niveles máximo y mínimo. Nunca intente pasar directamente de la posición 0 a la 1 ni volver de la posición 1 a la 0.

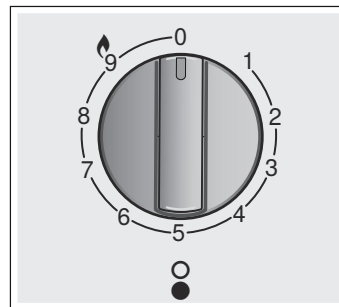

Indicaciones	
	Quemador controlado por el mando
0	Quemador apagado
9	Potencia máxima y encendido eléctrico
1	Potencia mínima

Para un correcto funcionamiento del aparato es imprescindible asegurarse de que las parrillas y todas las piezas de los quemadores estén bien colocadas. No intercambie las tapas de los quemadores.

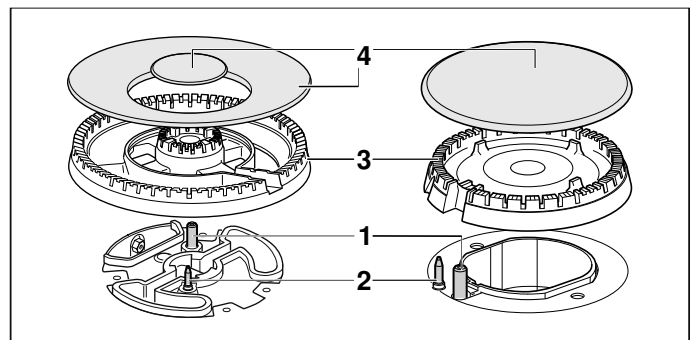

Elementos	
1	Bujía
2	Termopar
3	Difusor
4	Tapa

Quemadores de gas

Encendido manual

1. Presione el mando del quemador elegido y gírelo hacia la izquierda hasta la posición de máxima potencia.
2. Acerque algún tipo de encendedor o llama (mecheros, cerillas, etc.) al quemador.

Encendido automático

Si su placa de cocción dispone de encendido automático (bujías):

1. Presione el mando del quemador elegido y gírelo hacia la izquierda hasta la posición de máxima potencia. Mientras el mando está presionado se producen chispas en todos los quemadores. La llama se enciende.
2. Deje de presionar el mando.
3. Gire el mando a la posición deseada.

Si no se produce el encendido, gire el mando a la posición de apagado y repita los pasos. Esta vez mantenga el mando presionado durante más tiempo (hasta 10 segundos).

Advertencia – ¡Peligro de deflagración!

Si transcurridos 15 segundos la llama no se enciende, apague el quemador y abra la puerta o ventana del recinto. Espere al menos un minuto antes de intentar encender el quemador.

Nota: Mantenga la máxima limpieza. Si las bujías están sucias el encendido será defectuoso. Límpielas periódicamente con un cepillo no metálico pequeño. Tenga en cuenta que las bujías no deben sufrir impactos violentos.

Sistema de seguridad

Su placa de cocción dispone de un sistema de seguridad (termopar) que impide el paso de gas si los quemadores se apagan accidentalmente.

Para garantizar que este dispositivo esté activo:

1. Encienda el quemador con normalidad.
2. Sin soltar el mando, manténgalo presionado firmemente durante 4 segundos tras haberse encendido la llama.

Apagar un quemador

Gire el mando correspondiente hacia la derecha hasta la posición 0.

Unos segundos después del apagado del quemador se producirá un sonido (golpe seco). No es ninguna anomalía, eso significa que la seguridad se ha desactivado.

Advertencias

Durante el funcionamiento del quemador es normal que se escuche un leve silbido.

En los primeros usos es normal que se desprendan olores. Esto no supone ningún riesgo ni mal funcionamiento. Irán desapareciendo.

Una llama de color naranja es normal. Se debe a la presencia de polvo en el ambiente, líquidos derramados, etc.

En el caso de una extinción accidental de las llamas del quemador, cierre el mando de accionamiento del quemador y no intente reencenderlo durante por lo menos 1 minuto.

Tablas y consejos

Recipientes apropiados

Quemador	Diámetro mínimo del recipiente	Diámetro máximo del recipiente
Quemador wok	22 cm	- cm
Quemador rápido	22 cm	26 cm
Quemador semi-rápido	14 cm	20 cm

Advertencias de uso

Los siguientes consejos le ayudarán a ahorrar energía y a evitar daños en los recipientes:

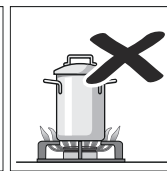
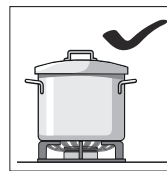

Utilice recipientes de tamaño apropiado a cada quemador. No utilice recipientes pequeños en quemadores grandes. La llama no debe tocar los laterales del recipiente.

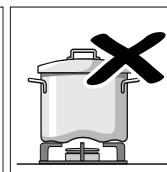
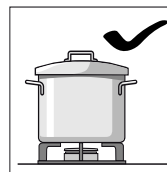

No utilice recipientes deformados que se muestren inestables sobre la placa de cocción. Los recipientes podrían volcar. Utilice solo recipientes de base plana y gruesa.

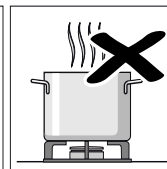
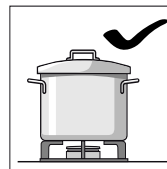

No cocine sin tapa o con esta desplazada. Se desperdicia parte de la energía.

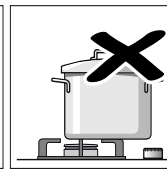
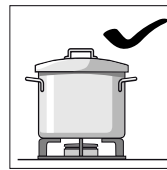

Coloque el recipiente bien centrado sobre el quemador. En caso contrario podría volcar. No coloque los recipientes grandes en los quemadores cercanos a los mandos. Estos pueden resultar dañados debido al exceso de temperatura.

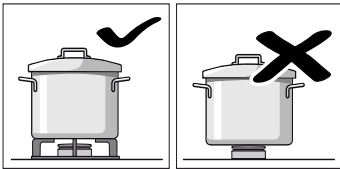

Coloque los recipientes sobre las parrillas, nunca directamente sobre el quemador. Asegúrese de que las parrillas y tapas de los quemadores estén bien colocadas antes de su uso.

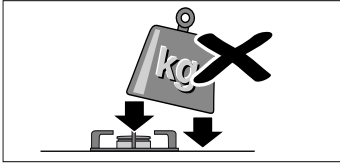

Maneje los recipientes con cuidado sobre la placa de cocción. No golpee la placa de cocción ni coloque sobre ella pesos excesivos.

Tabla de cocción

En la tabla siguiente se presentan las posiciones y tiempos de cocción óptimos para una selección de platos. Los datos son valores de referencia para cuatro comensales.

El tiempo y las posiciones de cocción dependen del tipo, peso y calidad de los alimentos así como del material de los recipientes de cocinado. Por este motivo pueden producirse variaciones.

Utilice siempre recipientes de cocinado de diámetros adecuados y colóquelos bien centrados sobre el quemador. Consulte la información relativa a los diámetros de recipientes de cocinado. → "Recipientes apropiados"

Cómo interpretar la tabla

La elaboración de cada plato consta de uno o dos pasos. Cada paso contiene información sobre:

- Método de cocción
- Posición de cocción
- Duración en minutos

Métodos de cocción indicados en la tabla

- Llevar a ebullición
- Mantener ebullición
- Ganar presión en olla a presión
- Mantener presión en olla a presión
- Freír fuerte
- Freír suave
- Derretir, fundir
- * Sin tapa
- ** Remover continuamente

Nota: Los símbolos no aparecen en el aparato, se utilizan como orientación sobre los cambios de modo de cocinado.

Se presentan indicaciones para cocinar cada plato en diferentes quemadores. La opción recomendada es el primer quemador mencionado. En el resumen de los modelos está identificado cada quemador de la placa de cocción. → *Página 2*

Ejemplo:

Plato	Tiempo total en min	Paso 1			Paso 2		
Quegador							
Sopas, cremas							
Sopa de pescado							
Rápido	12-17		8	7-9		1	5-8
Semi-rápido	17-22		8	11-13		1	6-9
Wok	10-15		9	6-8		4	4-7

En el ejemplo se muestran indicaciones para cocinar sopa de pescado utilizando los quemadores rápido, semi-rápido o wok.

Utilizando el quemador rápido (opción recomendada) el tiempo total para la cocción es de 12 a 17 minutos.

- Paso 1: llevar a ebullición. Utilice la posición de cocción 8 durante 7-9 minutos.
- Paso 2: mantener ebullición. Cambie a la posición 1 durante 5-8 minutos.

Las indicaciones para el resto de quemadores propuestos se deben interpretar de forma análoga.

Plato	Tiempo total en min	Paso 1			Paso 2			
Quegadores								
Sopas, cremas								
Sopa de pescado								
Rápido	12-17		8	7-9		1	5-8	
Semi-rápido	17-22		8	11-13		1	6-9	
Wok	10-15		9	6-8		4	4-7	
Crema de calabaza, sopa Borsch								
Rápido	30-35		9	10-12		5	20-23	
Semi-rápido	45-50		9	15-17		6	30-33	
Wok	25-30		9	8-10		2	17-20	
Minestrone (sopa de verduras)								
Rápido	47-52		9	10-12		5	37-40	
Semi-rápido	57-62		9	10-12		6	47-50	
Wok	43-48		8	8-10		3	35-38	
Pasta y arroz								
Espaguetis								
Rápido	18-22		*	9	8-10		6	10-12
Semi-rápido	20-24		*	9	10-12		7	10-12
Wok	18-22		*	8	8-10		6	10-12
Arroz								
Rápido	17-22			9	5-7		2	12-15
Semi-rápido	18-23			9	7-9		6	11-14
Wok	15-20			8	4-6		2	11-14

Plato	Quemadores	Tiempo total en min	Paso 1			Paso 2		
Ravioli								
Rápido		9-14		9	4-6		6	5-8
Semi-rápido		17-22		8	12-14		8	5-8
Wok		10-15		8	5-7		8	5-8
Verduras y legumbres								
Patatas cocidas (puré, ensaladilla rusa)								
Rápido		23-28		9	8-10		5	15-18
Semi-rápido		25-30		9	10-12		6	15-18
Wok		25-30		7	11-13		5	14-17
Hummus (puré de garbanzos)								
Rápido		50-55		9	10-12		4	40-43
Semi-rápido		52-57		9	12-14		5	40-43
Wok		47-52		7	10-12		5	37-40
Lentejas								
Rápido		40-45		9	8-10		9	32-35
Semi-rápido		50-55		9	18-20		6	32-35
Wok		45-50		6	20-22		4	25-28
Tempura de verduras								
Rápido		12-17		*7	6-8		*6	6-9
Semi-rápido		15-20		*8	8-10		*7	7-10
Wok		11-16		*7	6-8		*5	5-8
Salteado de verduras frescas**								
Wok		6-8		*9	6-8			
Rápido		6-8		*9	6-8			
Patatas fritas								
Wok		15-20		*7	15-20			
Rápido		15-20		*9	15-20			
Semi-rápido		25-30		*9	25-30			
Huevos								
Shakshuka								
Semi-rápido		15-20		9	10-12		4	5-8
Rápido		13-18		8	7-9		3	6-9
Wok		15-20		6	11-13		4	4-7
Tortilla francesa (1 ud.)								
Semi-rápido		3-5		*8	3-5			
Rápido		2-4		*9	2-4			
Wok		2-4		*5	2-4			
Tortilla de patata								
Rápido		25-30		*9	25-30			
Wok		18-23		*9	18-23			

Plato	Quemadores	Tiempo total en min	Paso 1			Paso 2		
Salsas								
Salsa bechamel**								
Semi-rápido		10-15		*5	2-4		*5	8-11
Wok		3-8		*5	1-2		*5	2-6
Rápido		3-8		*5	1-2		*5	2-6
Salsa de queso azul**								
Semi-rápido		3-5		*7	3-5			
Rápido		3-5		*5	3-5			
Salsa napolitana								
Semi-rápido		18-23		*6	2-4		*4	16-19
Wok		13-18		*7	1-3		*5	12-15
Rápido		15-20		*8	1-3		*6	14-17
Salsa carbonara								
Semi-rápido		10-15		*6	5-7		*3	5-8
Rápido		8-13		*5	4-6		*3	4-7
Pescado								
Merluza a la romana								
Rápido		5-10		*8	5-10			
Semi-rápido		8-13		*9	8-13			
Wok		4-9		*6	4-9			
Salmón asado								
Rápido		5-10		*7	2-4		1	3-6
Semi-rápido		5-10		*8	2-4		1	3-6
Wok		7-12		*8	2-4		1	5-8
Mejillones								
Rápido		5-7		9	5-7			
Wok		4-6		9	4-6			
Semi-rápido		10-12		9	10-12			
Carne								
Magret de pato (1 ud.)								
Semi-rápido		6-8		*7	6-8			
Rápido		9-11		*7	9-11			
Wok		6-8		*5	6-8			
Solomillo Strogonoff								
Rápido		8-13		*9	8-13			
Wok		5-10		*8	5-10			
Semi-rápido		12-17		*9	12-17			
Schnitzel de pollo (8 filetes de pechuga de pollo)								
Rápido		7-12		*9	2-4		*6	5-8
Wok		7-12		*9	2-4		*6	5-8
Semi-rápido		7-12		*9	7-12			

Plato	Tiem- po total en min	Paso 1	Paso 2
Quemadores			
Carne picada (pastel de carne, albóndigas, salsa boloñesa)			
Rápido	15-20	* 8	15-20
Semi-rápido	20-25	* 9	20-25
Wok	15-20	* 6	15-20
Productos preparados			
Croquetas congeladas (16 uds.)			
Varitas de pescado congeladas (12 uds.)			
Rápido	6-10	8	6-10
Wok	5-9	8	5-9
Semi-rápido	8-12	8	8-12
Salchichas fritas (12 uds.)			
Rápido	5-10	9	1-3 7 4-7
Semi-rápido	7-12	9	7-12
Wok	5-10	9	1-3 7 4-7
Salchichas calentadas en agua (12 uds.)			
Semi-rápido	8-13	9	8-13
Wok	9-14	4	9-14
Rápido	7-12	7	7-12
Hamburguesas (4 uds.)			
Rápido	4-9	* 9	1-3 * 7 3-6
Wok	4-9	* 9	1-3 * 7 3-6
Semi-rápido	5-10	* 9	1-3 * 8 4-7
Verduras congeladas**			
Rápido	7-12	* 9	7-12
Wok	5-10	* 9	5-10
Semi-rápido	12-17	* 9	12-17
Pizza (20 cm de diámetro)			
Wok	4-8	1	4-8
Rápido	16-20	1	16-20
Semi-rápido	20-25	1	20-25
Postres			
Pudin de arroz**			
Semi-rápido	30-35	* 8	9-11 * 4 21-24
Wok	35-40	* 7	11-13 * 1 24-27
Chocolate con leche			
Semi-rápido	16-20	* 1	16-20
Crepes (4 uds.)			
Rápido	17-22	* 7	1-3 * 5 16-19
Wok	8-13	* 7	1-3 * 4 7-10
Semi-rápido	20-25	* 8	1-3 * 6 19-22
Pudin de pan			
Rápido	25-30	9	10-12 6 15-18
Wok	23-28	9	8-10 7 15-18
Semi-rápido	27-32	9	10-12 7 17-20

Plato	Tiem- po total en min	Paso 1	Paso 2
Quemadores			
Natillas**			
Rápido	3-8	* 5	3-8
Semi-rápido	8-13	* 5	8-13
Wok	3-8	* 2	3-8
Bizcocho (al baño maría)			
Rápido	35-40	9	35-40
Wok	40-45	9	40-45
Semi-rápido	45-50	9	45-50

Consejos de cocinado

- Los tiempos de cocción de las cremas y legumbres pueden reducirse utilizando una olla a presión. Si utiliza una olla a presión siga las instrucciones del fabricante.
- Utilizando tapa para la cocción de arroz y patata se reduce significativamente el tiempo de cocción.
- Para las frituras se debe precalentar el aceite. Una vez iniciada la fritura del alimento, mantenga la temperatura constante ajustando la potencia si es necesario. Deje recuperar la temperatura del aceite entre diferentes lotes y dé vuelta a los alimentos frecuentemente.

Limpieza y cuidados del aparato

Limpieza

Una vez frío el aparato, límpielo con una esponja, agua y jabón.

Después de cada uso, limpie la superficie de los respectivos elementos del quemador una vez que se haya enfriado. Si se dejan restos (alimentos recocidos, gotas de grasa, etc.), por poco que sea, se incrustarán en la superficie y serán luego más difíciles de eliminar. Es necesario que los agujeros y ranuras estén limpios para que la llama sea correcta.

El movimiento de algunos recipientes puede dejar restos metálicos sobre las parrillas.

Limpie los quemadores y las parrillas con agua jabonosa y frótelos con un cepillo no metálico.

Si las parrillas disponen de tacos de goma, tenga cuidado al limpiarlas. Los tacos pueden soltarse y la parrilla puede rayar la placa de cocción.

Seque completamente los quemadores y las parrillas siempre. La presencia de gotas de agua o zonas húmedas al comienzo de la cocción puede deteriorar el esmalte.

Después de la limpieza y secado de los quemadores, asegúrese de que las tapas estén bien colocadas sobre el difusor.

¡Atención!

- No extraiga los mandos para la limpieza del aparato. Si la humedad penetra en el aparato puede dañarlo.
- No utilice máquinas de limpieza a vapor. Podría dañar la placa de cocción.
- No utilice nunca productos abrasivos, estropajos de acero, objetos cortantes, cuchillos, etc. para quitar restos de comida endurecidos de la placa de cocción.
- No utilice cuchillos, rasquetas o similar para limpiar la unión del cristal con los embellecedores de los quemadores, perfiles metálicos ni en los paneles de cristal o aluminio si hubiere.

Mantenimiento

Limpie al instante los líquidos que se derramen. Así evitará que los restos de comida se peguen y se ahorrará esfuerzos innecesarios.

No deslice sobre el vidrio los recipientes, ya que puede rayarlo. Asimismo evite caídas de objetos duros o puntiagudos sobre el cristal. No golpee la placa de cocción por ninguno de sus cantos.

Los granos de arena (procedentes, por ejemplo, de la limpieza de verduras y hortalizas) rayan la superficie del cristal.

El azúcar fundido o los alimentos con elevado contenido de azúcar que se hubieran derramado deberán eliminarse inmediatamente de la zona de cocción con ayuda de la rasqueta para vidrio.

¿Qué hacer en caso de avería?

En ocasiones, las anomalías detectadas se pueden solucionar fácilmente. Antes de llamar al Servicio Técnico tenga en cuenta los siguientes consejos:

Anomalía	Posible causa	Solución
El funcionamiento eléctrico general está averiado.	Fusible defectuoso.	Comprobar en la caja general de fusibles si el fusible está averiado y cambiarlo.
	El automático o un diferencial ha saltado.	Comprobar en el cuadro general de mando si ha saltado el automático o un diferencial.
El encendido automático no funciona.	Pueden existir residuos de alimentos o de limpieza entre las bujías y los quemadores.	El espacio entre la bujía y el quemador debe estar limpio.
	Los quemadores están mojados.	Secar cuidadosamente las tapas del quemador.
	Las tapas del quemador están mal colocadas.	Comprobar que las tapas están bien colocadas.
	El aparato no está conectado a tierra, está mal conectado o la toma de tierra es defectuosa.	Póngase en contacto con el instalador eléctrico.
La llama del quemador no es uniforme.	Las piezas del quemador están mal colocadas.	Colocar correctamente las piezas sobre el quemador correspondiente.
	Las ranuras del quemador están sucias.	Limpiar las ranuras del quemador.
El flujo de gas no parece normal o no sale gas.	El paso de gas está cerrado por llaves intermedias.	Abrir las posibles llaves intermedias.
	Si el gas proviene de una bombona, comprobar que no está vacía.	Cambiar la bombona.
Hay olor a gas en la cocina.	Algún grifo está abierto.	Cerrar los grifos.
	Mal acoplamiento de la bombona.	Comprobar que el acoplamiento es perfecto.
	Posible fuga de gas.	Cerrar la llave general de gas, ventilar el recinto y avisar inmediatamente a un técnico de instalación autorizado para la revisión y certificación de la instalación. No utilizar el aparato hasta asegurarse de que no existe ninguna fuga de gas en la instalación o el aparato.
El quemador se apaga inmediatamente después de soltar el mando.	No ha mantenido el mando presionado el tiempo suficiente.	Una vez encendido el quemador, mantener el mando presionado unos segundos más.
	Las ranuras del quemador están sucias.	Limpiar las ranuras del quemador.



Servicio de Asistencia Técnica

Si se solicita nuestro Servicio Técnico, se debe facilitar el número de producto (E-Nr.) y el número de fabricación (FD) del aparato. Esta información figura en la placa de características, situada en la parte inferior de la placa de cocción, y en la etiqueta del manual de uso.

Las señas de las delegaciones internacionales figuran en la lista adjunta de centros y delegaciones del Servicio de Asistencia Técnica Oficial.

Solicitud de reparación y asesoramiento en caso de averías

E 902 145 150

Confíe en la profesionalidad de su distribuidor. De este modo se garantiza que la reparación sea realizada por personal técnico especializado y debidamente instruido que, además, dispone de los repuestos originales del fabricante para su aparato doméstico.

Condiciones de garantía

Si, contrariamente a nuestras expectativas, el aparato presentara algún daño o no cumpliera con sus exigencias de calidad previstas, le rogamos nos lo haga saber lo antes posible. Para que la garantía tenga validez, el aparato no deberá haber sido manipulado, ni sometido a un mal uso.

Las condiciones de garantía aplicables son las establecidas por la representación de nuestra empresa en el país donde se haya efectuado la compra. Puede solicitarse información detallada en los puntos de venta. Es necesario presentar el justificante de compra para hacer uso de la garantía.

Reservado el derecho de modificaciones.



Protección del medio ambiente

Si en la placa de características del aparato aparece el símbolo , tenga en cuenta las siguientes indicaciones.

Eliminación de residuos respetuosa con el medio ambiente



Eliminar el embalaje de forma ecológica.











Este aparato está marcado con el símbolo de cumplimiento con la Directiva Europea 2012/19/UE relativa a los aparatos eléctricos y electrónicos usados (Residuos de aparatos eléctricos y electrónicos RAEE).

La directiva proporciona el marco general válido en todo el ámbito de la Unión Europea para la retirada y la reutilización de los residuos de los aparatos eléctricos y electrónicos.

El embalaje de su aparato se ha fabricado con los materiales estrictamente necesarios para garantizar una protección eficaz durante el transporte. Estos materiales son totalmente reciclables, reduciendo así el impacto medioambiental. Le invitamos a contribuir también en la conservación del medio ambiente, siguiendo los siguientes consejos:

- deposite el embalaje en el contenedor de reciclaje adecuado,
- antes de deshacerse de un aparato desechado, inutilícelo. Consulte en su administración local la dirección del centro recolector de materiales reciclables más próximo y entregue allí su aparato,
- no tire el aceite usado por el fregadero. Guárdelo en un recipiente cerrado y entréguelo en un punto de recogida o, en su defecto, en un contenedor de basura (acabará en un vertedero controlado; probablemente no es la mejor solución, pero evitamos la contaminación del agua).

Índice

	Utilização adequada.....	21
	Instruções de segurança importantes.....	22
	Conhecer o aparelho.....	23
	Elementos de comando e queimador.....	23
	Queimadores a gás.....	24
	Ligação manual.....	24
	Ignição automática.....	24
	Sistema de segurança.....	24
	Apagar um queimador.....	24
	Advertências.....	24
	Tabelas e sugestões.....	24
	Recipientes apropriados.....	24
	Advertências para utilização.....	24
	Tabela de cozedura.....	25
	Limpeza e manutenção.....	27
	Limpeza.....	27
	Manutenção.....	28
	Defeito: O que fazer?.....	28
	Serviços Técnicos.....	29
	Condições de garantia.....	29
	Protecção do meio ambiente.....	29
	Eliminação ecológica.....	29

Utilização adequada

Leia atentamente estas instruções. Só assim poderá manusear o aparelho de forma eficaz e segura. Conserve as instruções de uso e de instalação e entregue-as juntamente com o aparelho se este mudar de dono.

O fabricante fica isento de qualquer tipo de responsabilidade caso não se cumpram as disposições deste manual.

As imagens apresentadas ao longo das instruções servem apenas para orientação.

Não retire o aparelho da embalagem de protecção até ao momento de ser encastrado. Se observar algum dano no aparelho, não o ligue. Entre em contacto com o nosso Serviço de Assistência Técnica.

Este aparelho corresponde à classe 3, segundo a norma EN 30-1-1 para aparelhos a gás: aparelho encastrado num móvel.

Antes de instalar a sua nova placa de cozedura, certifique-se de que segue todas as instruções de montagem durante a instalação.

Este aparelho não pode ser instalado em iates ou caravanas.

Este aparelho deve ser apenas utilizado em locais com uma ventilação adequada.

Este aparelho não foi previsto para ser utilizado com um temporizador externo ou um telecomando externo.

Todos os trabalhos de instalação, ligação, regulação e adaptação a outros tipos de gás devem ser efectuados por um técnico autorizado, respeitando todas as regulamentações e legislação aplicáveis, bem como o estipulado pelas empresas locais fornecedoras de gás e electricidade. Deve prestar particular atenção às disposições aplicáveis relativamente à ventilação.

Este aparelho vem adaptado da fábrica para o tipo de gás indicado na placa de características. Caso seja necessário alterar o tipo de gás, consulte as instruções de montagem. Recomenda-se chamar o nosso Serviço de Assistência Técnica para a adaptação a outros tipos de gás.

Este aparelho foi unicamente concebido para utilização doméstica, não podendo, por isso,

ser utilizado para fins comerciais ou profissionais. Utilize o aparelho unicamente para cozinhar, nunca como aparelho de aquecimento. A garantia apenas será válida caso o aparelho seja utilizado correctamente e para os fins a que se destina.

O aparelho foi concebido para ser utilizado até a uma altitude de 2000 metros acima do nível do mar, no máximo.

Não deixe o aparelho a funcionar sem vigilância.

Não utilize tampas ou barreiras de protecção, para crianças, que não sejam recomendadas pelo fabricante da placa de cozedura. Podem provocar acidentes, por ex. devido ao sobreaquecimento, ignição ou libertação de fragmentos de materiais.

Este aparelho pode ser usado por crianças com mais de 8 anos e por pessoas com limitações físicas, sensoriais ou mentais ou com pouca experiência ou conhecimentos, se estiverem sob vigilância de uma pessoa responsável pela sua segurança ou tiverem sido instruídas acerca da utilização segura do aparelho e tiverem compreendido os perigos decorrentes da sua utilização.

As crianças não devem brincar com o aparelho. As tarefas de limpeza e manutenção por parte do utilizador não devem ser efectuadas por crianças, a não ser que tenham mais de 8 anos e estejam sob vigilância.

As crianças menores de 8 anos devem manter-se afastadas do aparelho e do cabo de ligação.

Instruções de segurança importantes

Aviso – Perigo de deflagração!

A acumulação do gás que não é queimado, num espaço fechado, pode causar deflagração. Não submeta o aparelho a correntes de ar. Os queimadores poderiam apagar-se. Leia atentamente as instruções e advertências relativas ao funcionamento dos queimadores a gás.

Aviso – Perigo de intoxicação!

A utilização de um aparelho de cozedura a gás produz calor, humidade e produtos de combustão no local onde está instalado. Garanta uma boa ventilação na cozinha, especialmente enquanto a placa de cozedura estiver em funcionamento: mantenha as aberturas de ventilação natural abertas ou instale um dispositivo de ventilação mecânica (campânula com exaustor). A utilização intensa e prolongada do aparelho pode requerer uma ventilação complementar ou mais eficaz: abra uma janela ou aumente a potência da ventilação mecânica.

Aviso – Perigo de queimaduras!

- As zonas de cozedura e zonas adjacentes aquecem muito. Nunca toque nas superfícies quentes. Mantenha as crianças com menos de 8 anos afastadas do aparelho.
- Quando a garrafa de gás de petróleo liquefeito (GPL) não está na vertical, pode passar propano/butano líquido para o aparelho, podendo originar labaredas intensas nos queimadores. Os componentes poderão ser danificados e, com o tempo, deixar de vedar correctamente, permitindo a saída descontrolada de gás. Qualquer destas situações pode provocar queimaduras. Coloque sempre garrafas de GPL na posição vertical.

Aviso – Perigo de incêndio!

- As zonas de cozedura aquecem muito. Não coloque objectos inflamáveis sobre a placa de cozedura. Não deixe objectos sobre a placa de cozedura.
- Não armazene nem utilize produtos químicos corrosivos, vapores, materiais inflamáveis ou produtos não alimentares por baixo deste electrodoméstico, nem perto dele.

- As gorduras ou óleos sobreaquecidos são facilmente inflamáveis. Não se ausente enquanto estiver a aquecer gorduras ou óleos. Se se inflamarem, não apague o fogo com água. Cubra o recipiente com uma tampa para apagar o fogo e desligue a zona de cozedura.

⚠ Aviso – Perigo de ferimentos!

- Fissuras ou fraturas na placa de vidro são perigosos. Desligue imediatamente todos os queimadores e elementos de aquecimento eléctricos. Retire a ficha da tomada ou desligue o fusível na caixa de fusíveis. Feche a alimentação de gás. Não toque na superfície do aparelho. Nunca ligue um aparelho defeituoso. Contacte a assistência técnica.
- Os recipientes que apresentem danos, com um tamanho inadequado, que ultrapassem as margens da placa de cozedura ou que estejam mal posicionados, podem provocar graves lesões. Tenha em consideração as recomendações e advertências relativas aos recipientes para cozinhados.
- Em caso de avaria, corte a alimentação eléctrica e o fornecimento de gás do aparelho. Para proceder à reparação, recorra ao nosso Serviço de Assistência Técnica.
- Não manipule o interior do aparelho. Se tal for necessário, recorra ao nosso Serviço de Assistência Técnica.
- Se algum dos comandos não rodar, não o force. Contacte imediatamente o Serviço de Assistência Técnica para proceder à reparação ou substituição.

⚠ Aviso – Perigo de descarga eléctrica!

- Não utilize máquinas de limpeza a vapor para limpar o aparelho.
- Se a placa de vidro estiver estalada ou apresentar falhas, pode dar origem a choques eléctricos. Desligue o disjuntor no quadro eléctrico. Contacte o serviço de assistência técnica.

Conhecer o aparelho

Na visão geral de modelos poderá encontrar o seu aparelho com as potências dos queimadores.

→ *Página 2*

Elementos de comando e queimador

Em qualquer comando está identificado o queimador correspondente. Com os comandos pode regular, de acordo com as diferentes posições, a potência necessária entre os valores máximos e mínimos. Nunca tente mudar da posição 0 diretamente para a posição 1 ou da posição 1 para a posição 0.

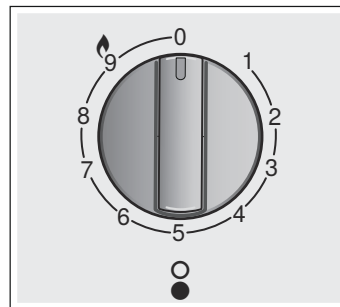

Indicações

	Queimador controlado pelo comando
0	Queimador desligado
9	Nível de potência máximo e ignição eléctrica
1	Nível de potência mínimo

Para um funcionamento correcto do aparelho é importante certificar-se de que as grelhas e todas as peças dos queimadores estão correctamente colocadas. Não troque as tampas dos queimadores.

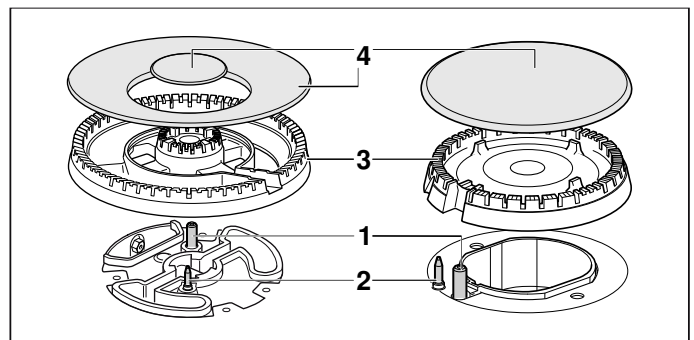

Elemento

1	Ficha
2	Elemento térmico
3	Boca do queimador
4	Tampa do queimador

Queimadores a gás

Ligação manual

1. Pressione os comandos do queimador selecionado e gire-os para a esquerda, até ao nível de potência mais elevado.
2. Chegue um acendedor ou uma chama (isqueiro, fósforo, etc.) ao queimador.

Ignição automática

Se a sua placa de cozinhar possuir ignição automática (fichas):

1. Pressione os comandos do queimador selecionado e gire-os para a esquerda, até ao nível de potência mais elevado. Enquanto mantiver os comandos pressionados, sairão faíscas de todos os queimadores. O queimador acende-se.
2. Solte os comandos.
3. Gire os comandos para a posição desejada.

Se não houver ignição, desligue o queimador e repita os passos descritos anteriormente. Desta vez mantenha os comandos pressionados durante mais tempo (até 10 segundos).

Aviso – Perigo de detonação!

Se o queimador não se acender após 15 segundos, desligue os comandos e abra a porta ou a janela do compartimento. Aguarde, pelo menos, um minuto, antes de acender novamente o queimador.

Conselho: Garanta a máxima limpeza. Se as fichas estiverem sujas, pode ocorrer uma ignição incorreta. Limpe as fichas regularmente com uma escova pequena, não metálica. Preste atenção para que as fichas não sejam sujeitas a impactos fortes.

Sistema de segurança

Esta placa de cozedura dispõe de um sistema de segurança (termopar) que impede a passagem do gás se os queimadores se apagarem acidentalmente.

Para garantir que este aparelho está activado:

1. Acenda o queimador normalmente.
2. Sem soltar o comando, mantenha-o firmemente pressionado durante 4 segundos após a chama se ter acendido.

Apagar um queimador

Rode o comando correspondente para a direita até à posição 0.

Alguns segundos depois de se apagar o queimador, emitir-se-á um som (som seco). Tal não é sinónimo de avaria, significa apenas que a segurança está desactivada.

Advertências

Durante o funcionamento do queimador, é normal que um ligeiro silvo seja emitido.

Quando utilizado inicialmente é normal que sejam libertados odores. Tal não constitui qualquer perigo nem é sinónimo de avaria. Os odores vão desaparecendo.

Uma chama cor-de-laranja é normal. Deve-se à presença de partículas de pó no ar, líquidos derramados, etc.

No caso de uma extinção acidental da chama do queimador, desligue o comando de accionamento do e não tente reacendê-lo durante, pelo menos, 1 minuto.

Tabelas e sugestões

Recipientes apropriados

Queimador	Diâmetro mínimo do recipiente	Diâmetro máximo do recipiente
Queimador para wok	22 cm	- cm
Queimador rápido	22 cm	26 cm
Queimador semi-rápido	14 cm	20 cm

Advertências para utilização

As seguintes recomendações ajudá-lo-ão a poupar energia e a evitar danos nos recipientes:

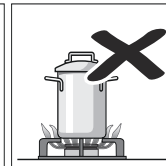
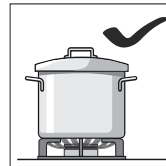

Utilize recipientes de tamanho adequado a cada queimador. Não utilize recipientes pequenos em queimadores grandes. A chama não deve tocar nos lados do recipiente.

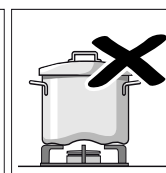
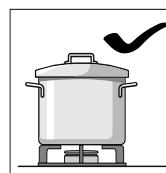

Não utilize recipientes deformados que não fiquem estáveis sobre a placa de cozedura. Os recipientes poderiam virar-se.

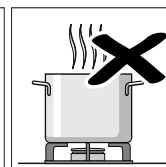
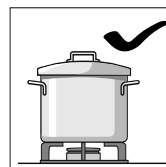

Utilize apenas recipientes de base plana e grossa. Não deve cozinhar sem tampa ou com a tampa mal colocada. Grande parte da energia é desperdiçada.

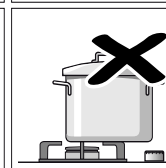
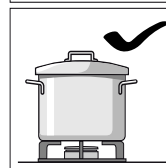

Coloque o recipiente bem centrado sobre o queimador. Caso contrário, o recipiente poderá virar-se. Não coloque os recipientes grandes sobre os queimadores próximos dos comandos. Estes podem ficar danificados devido ao excesso de temperatura.

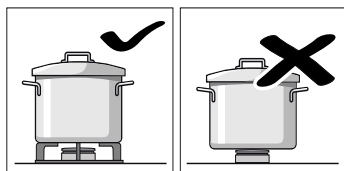

Coloque os recipientes sobre as grelhas e nunca directamente sobre o queimador.

Antes de utilizar, certifique-se de que as grelhas e as tampas dos queimadores estão bem colocadas .

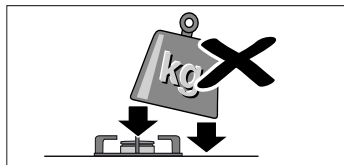

Manuseie os recipientes com cuidado sobre a placa de cozedura. Não golpee a placa de cozedura, nem coloque pesos excessivos sobre a mesma.

Tabela de cozedura



A tabela seguinte inclui as potências e os tempos de cozedura ideais para diferentes pratos. Os dados indicados são valores de referência para quatro pessoas.

Os tempos e as potências de cozedura dependem do tipo, peso e qualidade dos alimentos, bem como do material do recipiente para cozinhar. É, por isso, possível que existam divergências.







Utilize sempre um recipiente com tamanho adequado e posicione-o no centro do queimador. Consulte as informações sobre o diâmetro do recipiente para cozinhar. → "Recipientes apropriados"

Informações sobre a tabela

A preparação de cada prato é composta por um ou dois passos. Cada passo inclui informações sobre:

-  Método de cozedura
-  Potência de cozedura
-  Tempo de duração em minutos













Métodos de cozedura indicados na tabela

-  Ferver
-  Retomar a cozedura
-  Formar pressão na panela de pressão
-  Manter pressão na panela pressão
-  Saltear bem
-  Saltear ligeiramente
-  Derreter
- * Sem tampa
- ** Mexer continuamente

Conselho: Estes símbolos não se encontram no aparelho. Servem de orientação para os diferentes métodos de cozedura.

Na tabela encontra dados para a preparação de pratos em diferentes queimadores. A opção recomendada é o primeiro queimador. Na visão geral de modelos são descritos todos os queimadores da placa de cozinhar. → *Página 2*

Exemplo:





































Prato	Tempo total em min.	Passo 1			Passo 2		
Queimadores							
Sopas, sopas cremosas							
Sopa de peixe							
Rápido	12-17		8	7-9		1	5-8
Normal	17-22		8	11-13		1	6-9
Wok	10-15		9	6-8		4	4-7

Este exemplo mostra a preparação de sopa de peixe com a ajuda do queimador rápido, do queimador normal e do queimador para wok.

Com o queimador rápido (opção recomendada), o tempo total de cozedura é de 12 a 17 minutos.

















































- Passo 1: Ferver. Utilize a potência de cozedura 8 durante 7-9 minutos.
- Passo 2: Retomar a cozedura. Mude para a potência de cozedura 1 durante 5-8 minutos.













Proceda do mesmo modo se estiver a utilizar um dos outros queimadores sugeridos.

Prato	Tempo total em min.	Passo 1			Passo 2		
Queimadores							
Sopas, sopas cremosas							
Sopa de peixe							
Rápido	12-17		8	7-9		1	5-8
Normal	17-22		8	11-13		1	6-9
Wok	10-15		9	6-8		4	4-7
Creme de abóbora, sopa Borsch							
Rápido	30-35		9	10-12		5	20-23
Normal	45-50		9	15-17		6	30-33
Wok	25-30		9	8-10		2	17-20
Minestrone (sopa de legumes)							
Rápido	47-52		9	10-12		5	37-40
Normal	57-62		9	10-12		6	47-50
Wok	43-48		8	8-10		3	35-38
Massas e arroz							
Esparguete							
Rápido	18-22		9	8-10		6	10-12
Normal	20-24		9	10-12		7	10-12
Wok	18-22		8	8-10		6	10-12
Arroz							
Rápido	17-22		9	5-7		2	12-15
Normal	18-23		9	7-9		6	11-14
Wok	15-20		8	4-6		2	11-14

Prato	Queimadores	Tempo total em min.	Passo 1			Passo 2		
Ravioli								
Rápido		9-14		9	4-6		6	5-8
Normal		17-22		8	12-14		8	5-8
Wok		10-15		8	5-7		8	5-8
Legumes e leguminosas								
Batatas cozidas (puré, salada de batata)								
Rápido		23-28		9	8-10		5	15-18
Normal		25-30		9	10-12		6	15-18
Wok		25-30		7	11-13		5	14-17
Humus (grão-de-bico cozido)								
Rápido		50-55		9	10-12		4	40-43
Normal		52-57		9	12-14		5	40-43
Wok		47-52		7	10-12		5	37-40
Lentilhas								
Rápido		40-45		9	8-10		9	32-35
Normal		50-55		9	18-20		6	32-35
Wok		45-50		6	20-22		4	25-28
Legumes fritos								
Rápido		12-17		* 7	6-8		* 6	6-9
Normal		15-20		* 8	8-10		* 7	7-10
Wok		11-16		* 7	6-8		* 5	5-8
Legumes frescos salteados**								
Wok		6-8		* 9	6-8			
Rápido		6-8		* 9	6-8			
Batatas fritas								
Wok		15-20		* 7	15-20			
Rápido		15-20		* 9	15-20			
Normal		25-30		* 9	25-30			
ovos								
Xacuca								
Normal		15-20		9	10-12		4	5-8
Rápido		13-18		8	7-9		3	6-9
Wok		15-20		6	11-13		4	4-7
Omeleta (1 porção)								
Normal		3-5		* 8	3-5			
Rápido		2-4		* 9	2-4			
Wok		2-4		* 5	2-4			
Tortilha espanhola								
Rápido		25-30		* 9	25-30			
Wok		18-23		* 9	18-23			

Prato	Queimadores	Tempo total em min.	Passo 1			Passo 2		
Molhos								
Molho Béchamel**								
Normal		10-15		* 5	2-4		* 5	8-11
Wok		3-8		* 5	1-2		* 5	2-6
Rápido		3-8		* 5	1-2		* 5	2-6
Molho com queijo de pasta azul**								
Normal		3-5		* 7	3-5			
Rápido		3-5		* 5	3-5			
Molho napolitano								
Normal		18-23		* 6	2-4		* 4	16-19
Wok		13-18		* 7	1-3		* 5	12-15
Rápido		15-20		* 8	1-3		* 6	14-17
Molho carbonara								
Normal		10-15		* 6	5-7		* 3	5-8
Rápido		8-13		* 5	4-6		* 3	4-7
Peixe								
Pescada romana								
Rápido		5-10		* 8	5-10			
Normal		8-13		* 9	8-13			
Wok		4-9		* 6	4-9			
Salmão assado								
Rápido		5-10		* 7	2-4		1	3-6
Normal		5-10		* 8	2-4		1	3-6
Wok		7-12		* 8	2-4		1	5-8
Moluscos								
Rápido		5-7		9	5-7			
Wok		4-6		9	4-6			
Normal		10-12		9	10-12			
Carne								
Peito de pato (1 unid.)								
Normal		6-8		* 7	6-8			
Rápido		9-11		* 7	9-11			
Wok		6-8		* 5	6-8			
Lombo de novilho, strogonoff								
Rápido		8-13		* 9	8-13			
Wok		5-10		* 8	5-10			
Normal		12-17		* 9	12-17			
Escalopes de frango (8 filetes de peito de frango)								
Rápido		7-12		* 9	2-4		* 6	5-8
Wok		7-12		* 9	2-4		* 6	5-8
Normal		7-12		* 9	7-12			

Prato	Tempo total em min.	Passo 1	Passo 2
Queimadores		  	  
Carne picada (patês, almôndegas, molho à bolonesa)			
Rápido	15-20	 * 8	15-20
Normal	20-25	 * 9	20-25
Wok	15-20	 * 6	15-20
Produtos pré-confeccionados			
Croquetes congelados (16 unid.)			
Barrinhas de peixe congeladas (12 unid.)			
Rápido	6-10	 8	6-10
Wok	5-9	 8	5-9
Normal	8-12	 8	8-12
Salsichas (12 unid.)			
Rápido	5-10	 9	1-3  7 4-7
Normal	7-12	 9	7-12
Wok	5-10	 9	1-3  7 4-7
Salsichas (12 unid.)			
Normal	8-13	 9	8-13
Wok	9-14	 4	9-14
Rápido	7-12	 7	7-12
Hambúrguer (4 unid.)			
Rápido	4-9	 * 9	1-3  * 7 3-6
Wok	4-9	 * 9	1-3  * 7 3-6
Normal	5-10	 * 9	1-3  * 8 4-7
Legumes congelados**			
Rápido	7-12	 * 9	7-12
Wok	5-10	 * 9	5-10
Normal	12-17	 * 9	12-17
Pizza (20 cm de diâmetro)			
Wok	4-8	 1	4-8
Rápido	16-20	 1	16-20
Normal	20-25	 1	20-25
Sobremesas			
Pudim de arroz**			
Normal	30-35	 * 8	9-11  * 4 21-24
Wok	35-40	 * 7	11-13  * 1 24-27
Chocolate de leite			
Normal	16-20	 * 1	16-20
Crepes (4 unid.)			
Rápido	17-22	 * 7	1-3  * 5 16-19
Wok	8-13	 * 7	1-3  * 4 7-10
Normal	20-25	 * 8	1-3  * 6 19-22
Pudim de pão			
Rápido	25-30	 9	10-12  6 15-18
Wok	23-28	 9	8-10  7 15-18
Normal	27-32	 9	10-12  7 17-20

Prato	Tempo total em min.	Passo 1	Passo 2
Queimadores		  	  
Pudim espanhol**			
Rápido	3-8	 * 5	3-8
Normal	8-13	 * 5	8-13
Wok	3-8	 * 2	3-8
Bolo de massa batida (em banho-maria)			
Rápido	35-40	 9	35-40
Wok	40-45	 9	40-45
Normal	45-50	 9	45-50

Dicas para cozinhar

- Para preparar sopas cremosas e leguminosas, utilize uma panela de pressão. O tempo de cozedura diminui claramente. Se utilizar uma panela de pressão, siga as instruções do fabricante.
- Coloque sempre uma tampa para cozinhar batatas e arroz. O tempo de cozedura diminui, assim, claramente.
- No caso de pratos na frigideira, é necessário aquecer primeiro o óleo. Assim que tiver começado a fritar, mantenha a temperatura constante, ajustando, se necessário, a potência de cozedura. Se estiver a preparar várias porções, aguarde até que a temperatura de cozedura seja novamente alcançada. Vire os alimentos regularmente.



Limpeza e manutenção

Limpeza

Deixe o aparelho arrefecer e limpe-o com uma esponja, água e detergente.

Depois de cada utilização, limpe a superfície dos respectivos elementos do queimador assim que o mesmo tiver arrefecido. Se forem deixados restos (alimentos ressequidos, gotas de gordura, etc.), por mínimos que sejam, estes irão ficar colados à superfície, sendo mais difíceis de remover. É necessário que os furos e as ranhuras estejam limpos para que a chama se forme correctamente.

O movimento de alguns recipientes pode deixar restos metálicos sobre as grelhas.

Limpe os queimadores e as grelhas com água e detergente e esfregue-os com uma escova não metálica.

Se as grelhas tiverem bases de borracha, tenha cuidado ao limpá-las. As bases podem soltar-se e a grelha pode riscar a placa de cozedura.

Seque sempre os queimadores e as grelhas completamente. Se houver água ou zonas húmidas, no início da cozedura, pode deteriorar o esmalte.

Depois da limpeza e secagem dos queimadores, verifique se as tampas estão bem colocadas sobre o difusor.

Atenção!

- Não tire os elementos de comando para limpar o aparelho. A entrada de humidade pode danificar o aparelho.
- Não utilize máquinas de limpeza a vapor. Poderá danificar a placa de cozedura.
- Nunca utilize produtos abrasivos, esfregões de aço, objectos cortantes, facas, etc. para remover restos de comida ressequidos da placa de cozedura.
- Não utilize facas, raspadores ou utensílios similares para limpar a união do vidro com as tampas dos queimadores, os perfis metálicos nem os painéis de vidro ou alumínio, se existentes.

Manutenção

Limpe imediatamente, em caso de derrame de líquidos. Desta forma, evita que restos de comida se agarrem, o que dificulta a limpeza.

Não deslize os recipientes sobre o vidro, já que poderia riscar-se. Pelo mesmo motivo, não deixe cair objectos duros ou pontiagudos sobre o vidro. Não golpeie as esquinas da placa de cozedura.

Os grãos de areia (provenientes, por exemplo, da limpeza de legumes e hortalças) riscam a superfície do vidro.

O açúcar queimado ou outros alimentos com elevado teor de açúcar que tenham sido derramados, devem ser imediatamente limpos da zona de cozedura utilizando uma espátula de vidro.

? Defeito: O que fazer?

Em alguns casos, as avarias ocorridas podem ser fáceis de eliminar. Antes de contactar o serviço de assistência técnica, tenha em atenção as seguintes indicações:

Anomalia	Causa possível	Solução
O funcionamento eléctrico geral está avariado.	Fusível defeituoso.	Verificar o fusível na caixa geral de fusíveis e substituir, caso esteja avariado.
	O interruptor termomagnético ou diferencial disparou.	Verificar se o interruptor termomagnético ou diferencial disparou no quadro de distribuição de energia.
O acendimento automático não funciona.	Podem existir restos de alimentos ou de produtos de limpeza entre as bugias e os queimadores.	Este espaço, entre a bugia e o queimador, deve estar limpo.
	Os queimadores estão molhados.	Secar cuidadosamente as tampas dos queimadores.
	As tampas dos queimadores estão mal colocadas.	Certificar-se de que as tampas estão correctamente colocadas.
	O aparelho não está ligado à terra, está mal ligado ou a tomada de terra está defeituosa.	Contactar o instalador eléctrico.
A chama do queimador não é uniforme.	As peças do queimador estão mal colocadas.	Colocar correctamente as peças sobre o queimador correspondente.
	As ranhuras do queimador estão sujas.	Limpar as ranhuras do queimador.
O fluxo de gás não parece normal ou não sai gás.	A passagem de gás está fechada por chaves intermédias.	Abrir as possíveis chaves intermédias.
	Se o gás for fornecido por uma botija, verificar se esta não está vazia.	Substituir a botija.
Há um cheiro a gás na cozinha.	Está uma torneira aberta.	Fechar as torneiras.
	Acoplamento incorrecto da botija.	Verificar se o acoplamento está correcto.
	Possível fuga de gás.	Fechar a torneira geral de segurança, arejar o espaço onde se encontra e contactar imediatamente um técnico de instalação autorizado para fazer a revisão e certificação da instalação. Voltar a utilizar o aparelho apenas quando tiver a certeza de que não existe qualquer fuga de gás na instalação ou no próprio aparelho.
O queimador desliga-se imediatamente após soltar o comando.	O comando não foi pressionado durante tempo suficiente.	Depois de o queimador estar aceso, manter o comando pressionado durante mais uns segundos.
	As ranhuras do queimador estão sujas.	Limpar as ranhuras do queimador.

Serviços Técnicos

Se solicitar o nosso Serviço de Assistência Técnica, deve indicar o número do produto (E-Nr.) e o número de fabrico (FD) do aparelho. Esta informação consta da placa de características, situada na parte inferior da placa de cozedura e na etiqueta do manual de utilização.

Os dados para contacto com todos os países encontram-se no índice dos Serviços Técnicos anexo.

Ordem de reparação e apoio em caso de anomalias **PT 21 4250 740**

Confie na competência do fabricante. Assim, poderá ter a certeza de que a reparação é executada por técnicos especializados com a devida formação e com as peças de reparação originais para o seu aparelho.

Condições de garantia

Se, contrariamente às nossas expectativas, o aparelho apresentar algum dano ou se não cumprir com as exigências de qualidade previstas, solicitamos que nos comunique o mais rápido possível. Para que o serviço de garantia seja válido, o aparelho não deverá ter sido manipulado, nem submetido a uma má utilização.

As condições de garantia vigentes são as estabelecidas pelo representante da nossa empresa no país onde se realizou a compra. Informações pormenorizadas podem ser obtidas nos pontos de venda. É necessário apresentar o comprovativo de compra para beneficiar do serviço de garantia.

Reserva-se o direito de realizar alterações.

Protecção do meio ambiente

Se o símbolo  estiver na placa de características do aparelho, tenha em atenção as seguintes indicações.

Eliminação ecológica

Elimine a embalagem de forma ecológica.









Este aparelho está marcado em conformidade com a Directiva 2012/19/UE relativa aos resíduos de equipamentos eléctricos e electrónicos (waste electrical and electronic equipment - WEEE).

A directiva estabelece o quadro para a criação de um sistema de recolha e valorização dos equipamentos usados válido em todos os Estados Membros da União Europeia.

A embalagem do seu aparelho foi fabricada com os materiais estritamente necessários para garantir uma protecção eficaz durante o transporte. Estes materiais são totalmente recicláveis, sendo assim reduzido o impacto ambiental. Convidamo-lo a participar também na conservação do meio ambiente, cumprindo com as seguintes recomendações:

- deposite a embalagem no contentor de reciclagem adequado,
- antes de se desfazer de qualquer aparelho, inutilize-o. Consulte a administração local para saber o endereço do centro de recolha de materiais recicláveis mais próximo e entregue aí o seu aparelho,
- não deite fora o óleo utilizado pelo lava-louça. Guarde-o num recipiente fechado e entregue-o num centro de recolha ou, na sua falta, deposite-o num contentor de lixo orgânico (acabará por ser depositado num aterro controlado; provavelmente não é a melhor solução, mas desta forma evitamos a contaminação da água.

İçindekiler

	Amacına uygun kullanım	30
	Önemli güvenlik uyarıları	31
	Cihazı tanıyınız	32
	Kumanda elemanları ve brülör	32
	Gaz brülörleri	33
	Manuel olarak açılması	33
	Otomatik ateşleme	33
	Emniyet sistemi	33
	Brülörün kapatılması	33
	Uyarılar	33
	Tablo ve öneriler	33
	Uygun kaplar	33
	Kullanım Uyarıları	33
	Pişirme tablosu	34
	Temizlenmesi ve bakıma tabi tutulması	36
	Temizlik	36
	Bakım	36
	Arıza halinde ne yapmalı?	37
	Yetkili servisin çağırılması	38
	Garanti koşulları	38
	Çevre koruma	38
	Çevre kurallarına uygun şekilde imha edilmesi	38

Amacına uygun kullanım

Talimatları dikkatle okuyunuz. Ancak bu şekilde cihazın etkin ve güvenli kullanımı mümkün olacaktır. Kullanım ve kurulum talimatlarını saklayınız ve cihazın sahibinin değişmesi durumunda cihazla birlikte veriniz.

Bu kılavuzdaki kurallara uyulmadığı takdirde, üretici herhangi bir sorumluluktan muaf olacaktır.

Bu talimatlarda yer alan resimler bilgilendirme amaçlıdır.

Ürün yerleştirilene kadar koruyucu ambalajı çıkarmayınız. Cihazda herhangi bir hasar fark ettiğiniz takdirde cihazı çalıştırmayınız. Teknik Servisimiz ile irtibata geçiniz.

Bu EN 30-1-1 gazlı cihazlar normuna göre 3. sınıf bir cihazdır: mobilyaya gömme cihaz.

Yeni pişirme tezgahınızı kurmadan önce kurulumun montaj talimatlarına uygun gerçekleştirildiğinden emin olunuz.

Bu cihaz yat veya karavanlara kurulamaz.

Bu cihaz yalnızca yeterince havalandırılan yerlerde kullanılmalıdır.

Bu cihaz harici bir zamanlayıcı veya uzaktan kumanda ile kullanılmak üzere tasarlanmamıştır.

Bütün kurulum, bağlantı, ayarlama ve gaz tipine göre uyarılama işlemleri yetkili bir kurulum teknisyeni tarafından, ülkedeki standartlara ve yürürlükteki kanuni yönergeler ile yerel gaz ve elektrik tedarikçisi şirketin talimatlarına uygun olarak gerçekleştirilmelidir. Havalandırma ile ilgili geçerli düzenlemelere özel bir dikkat gösterilecektir.

Bu cihaz, fabrikadan özellikler tablosunda belirtilen gaz tipine ayarlı olarak çıkar. Gerekirse değiştiriniz, montaj talimatlarına uyunuz. Diğer gaz tiplerine uyarılama gerektiğinde Teknik Servisimizi çağırmanız önerilir.

Bu cihaz evde kullanım için tasarlanmıştır, ticari veya profesyonel amaçlarla kullanılamaz. Cihazı kesinlikle ısınma amacı ile kullanmayınız, sadece pişirme için kullanınız. Garanti sadece tasarım amacına uygun kullanılması durumunda geçerlidir.

Bu cihaz, deniz seviyesinden en fazla 2000 metre yükseklikte kullanılmak üzere tasarlanmıştır.

Çalışma sırasında cihazı kontrolsüz bir şekilde bırakmayınız.

Çocuklar için, pişirme tezgahı üreticisi tarafından önerilmemiş kapaklar veya bariyerler kullanmayınız. Örn. aşırı ısınma, alev alma veya malzeme parçalarının kopması dolayısıyla kazalara yol açabilirler.

Bu cihaz 8 yaşından küçük çocuklar, sınırlı fiziksel, zihinsel ve duygusal yeteneklere sahip kişiler ve eksik tecrübe veya bilgi sahibi kişiler tarafından ancak sorumlu bir kişinin denetimi altında olmaları veya kendilerine cihazın güvenli kullanımı ve ortaya çıkabilecek tehlikeler hakkında bilgi verilmiş olması durumunda kullanılabilir.

Çocuklar cihazla oynamamalıdır. Temizlik ve kullanıcı bakımı çocuklar tarafından yapılamaz; ancak 8 yaşından büyük çocuklar denetim altında yapabilir.

8 yaşından küçük çocukları cihazdan ve bağlantı kablosundan uzak tutunuz.

Önemli güvenlik uyarıları

Uyarı – Yangın tehlikesi!

Kapalı bir ortamda yanma olmaksızın gaz birikimi yangın tehlikesine yol açar. Cihazı hava akımına maruz bırakmayınız. Brülörler sönebilir. Gaz brülörlerinin çalışmasıyla ilgili talimatları ve uyarıları dikkatle okuyunuz.

Uyarı – Zehirlenme tehlikesi!

Gazlı bir pişirme cihazının kullanımı, kurulu olduğu yerde ısı, nem ve yanma ürünleri üretir. Özellikle cihazınız çalışır durumdayken mutfağın iyi havalandırılmasını sağlayınız: Tüm doğal havalandırma kanallarını açık tutunuz veya mekanik bir havalandırma (havalandırma fanı) cihazı kurunuz. Cihazın yoğun bir şekilde ve uzun süre kullanımı, tamamlayıcı veya daha etkili bir havalandırma gerektirebilir: Bir pencere açınız veya mekanik havalandırmanın gücünü arttırınız.

Uyarı – Yanma tehlikesi!

- Pişirme bölümleri ve etrafındakiler çok ısınır. Sıcak yüzeylere kesinlikle dokunmayınız. 8 yaşından küçük çocukları uzak tutunuz.
- LPG dik konulmadığı takdirde sıvı haldeki Propan/Butan cihaz içerisine girebilir. Bu sebeple brülörlerde ani alev oluşabilir. Parçalar zarar görebilir ve zamanla kontrol edilemeyen gaz çıkışlarına sebep olacak sızdırma problemleri ortaya çıkabilir. Her ikisi de yanmaya neden olabilir. LPG tüpleri her zaman dik konumda kullanınız.

Uyarı – Yangın tehlikesi!

- Pişirme bölümleri çok ısınır. Pişirme tezgahının üzerine yanıcı cisimler yerleştirmeyiniz. Pişirme tezgahı üzerinde eşya bırakmayınız.
- Bu elektrikli ev aletinin yakınında aşındırıcı, buharlaştırıcı kimyasal ürünler, yanıcı materyaller, besin dışında ürünler bulundurmuyunuz ve kullanmayınız.
- Aşırı ısınmış katı ya da sıvı yağlar kolay alev alır. Yağ kızdırırken ocaktan uzaklaşmayınız. Alev alması halinde ateşi su ile söndürmeyiniz. Ateşi söndürmek için kabı bir kapakla kaplayınız ve pişirme bölümünü kapatınız.

⚠ Uyarı – Yaralanma tehlikesi!

- Cam plakadaki çatlaklar veya kırıklar tehlikelidir. Tüm ocakları ve elektrikli ısıtıcı parçaları gecikmeden kapatınız. Elektrik fişini çekiniz veya sigorta kutusundaki sigortayı kapatınız. Gaz beslemesini kapatınız. Cihaz yüzeyine dokunmayınız. Arızalı bir cihazı kesinlikle açmayınız. Yetkili servisi çağırınız.
- Hasarlı, uygun boyuta sahip olmayan, pişirme tezgahının sınırlarını aşan veya kötü yerleştirilmiş kaplar ciddi yaralanmalara sebebiyet verebilir. Pişirme kaplarıyla ilgili tavsiye ve uyarılara uyunuz.
- Arıza olması durumunda cihazın elektrik ve gaz beslemesini kesiniz. Tamir için teknik servisimizi arayınız.
- Cihazın iç kısmını kurcalamayınız. Gerekli olduğu takdirde, teknik servisimizi arayınız.
- Kumanda düğmelerinden biri dönmeyecek olduğunda zorlamayınız. Tamir ya da değiştirme için derhal teknik servisi arayınız.

⚠ Uyarı – Elektrik çarpma tehlikesi!

- Cihazı temizlemek için buharlı temizleme makinesi kullanmayınız.
- Cam plakada oluşan çatlama veya kırılmalar elektrik çarpmasına neden olabilir. Sigortayı sigorta kutusundan kapatınız. Müşteri hizmetlerini arayınız.

👁 Cihazı tanıyınız

Modele genel bakış içinde cihazınızı ve ocak güçlerini bulabilirsiniz. → Sayfa 2

Kumanda elemanları ve brülör

Her kumanda düğmesinde ilgili brülör işaretlenmiştir. Kumanda düğmeleri üzerindeki farklı pozisyonları kullanarak ihtiyaç duyduğunuz gücü maksimum ve minimum değerler arasında istediğiniz gibi ayarlayabilirsiniz. Asla pozisyon 0'dan pozisyon 1'e veya pozisyon 1'den pozisyon 0'a geçmeyi denemeyiniz.

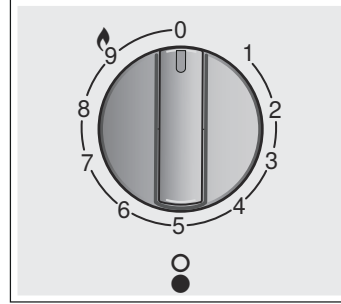
**Göstergeler**

🔴	Kumanda düğmesiyle kontrol edilen brülör
0	Kapalı brülör
9	En yüksek güç seviyesi ve elektrikli ateşleme
1	En düşük güç seviyesi

Cihazın doğru çalıştırılabilmesi için ızgaraların ve tüm brülör parçalarının doğru yerleştirildiğinden emin olunmalıdır. Brülör kapaklarının yerini değiştirmeyiniz.

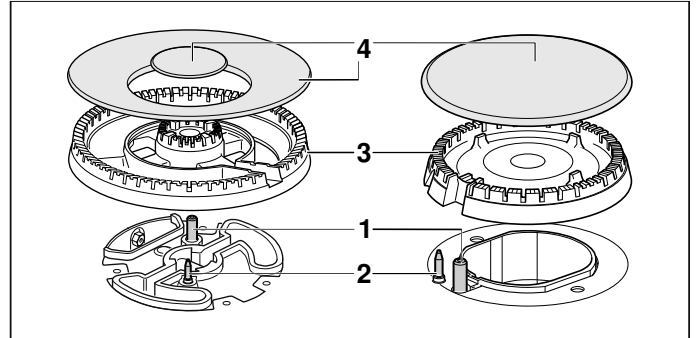
**Elemanlar**

1	Buji
2	Termik eleman
3	Brülör başlığı
4	Brülör kapağı

Gaz brülörleri

Manuel olarak açılması

1. Seçtiğiniz ocağın kumanda düğmesine basınız ve düğmeyi en yüksek güç seviyesine ulaşana kadar sola doğru döndürünüz.
2. Brülöre bir yakıcı veya bir alev (çakmak, kibrit vb.) yaklaştırınız.

Otomatik ateşleme

Eğer ocağınızda bir otomatik ateşleme mevcutsa (bujiler):

1. Seçtiğiniz ocağın kumanda düğmesine basınız ve düğmeyi en yüksek güç seviyesine ulaşana kadar sola doğru döndürünüz. Kumanda düğmesini basılı tuttuğunuz sürece tüm brülörlerin yanında kıvılcımlar çıkar. Brülör yanar.
2. Kumanda düğmesini serbest bırakınız.
3. Kumanda düğmesini istediğiniz pozisyona getiriniz.

Ateşleme gerçekleşmezse brülörü kapatınız ve tanımlanan adımları yeniden uygulayınız. Bu defa kumanda düğmesini daha uzun süre basılı tutunuz (azami 10 saniye).

⚠ Uyarı – Alev alma tehlikesi!

Eğer brülör 15 saniye sonunda yanmazsa kumanda düğmesini kapatınız ve içinde bulunduğunuz odanın kapısını veya penceresini açınız. Brülörü yeniden yakmadan önce en az bir dakika bekleyiniz.

Bilgi: Temizliğe çok dikkat ediniz. Bujiler kirlenmişse hatalı bir ateşleme yapılabilir. Bujileri düzenli olarak küçük, metalik olmayan bir fırçayla temizleyiniz. Bujilerin ciddi darbelere maruz kalmamasına dikkat ediniz.

Emniyet sistemi

Pişirme tezgahınız, brülörlerin kazayla yanması halinde gaz geçişini engelleyen bir emniyet sistemine (termo kupl) sahiptir.

Bu sistemin etkin olduğundan emin olmak için:

1. Brülörü normal olarak açınız
2. Kumanda düğmesini bırakmadan ateş yandıktan sonra kumandayı 4 saniye daha hafifçe basılı tutunuz.

Brülörün kapatılması

Kapatmak için kumanda düğmesini sağa çevirerek 0 pozisyonuna getiriniz.

Kapatıldıktan birkaç saniye sonra brülörden ses gelecektir (hafif tıkırtı). Bu herhangi bir anormallik değildir, emniyetin devre dışı olduğu anlamına gelir.

Uyarılar

Brülörün çalışması sırasında hafif bir ılık sesi duyulması normaldir.

İlk kullanımlarda koku gelmesi normaldir. Bu, herhangi bir risk ya da hatalı çalışma anlamına gelmez. Zamanla geçecektir.

Turuncu renkli alev normaldir. Havadaki tozdan, taşan sıvılardan vb. kaynaklanır.

Brülör alevlerinin yanlılıkla sönmesi durumunda brülörün kumanda düğmesini kapatınız ve en az 1 dakikadan önce yeniden yakmaya çalışmayınız.

Tablo ve öneriler

Uygun kaplar

Brülör	Kabın minimum çapı	Kabın maksimum çapı
Wok tipi brülör	22 cm	- cm
Hızlı brülör	22 cm	26 cm
Orta-hızlı brülör	14 cm	20 cm

Kullanım Uyarıları

Aşağıdaki öneriler enerji tasarrufuna ve kapların zarar görmesini önlemeye yardımcı olur:

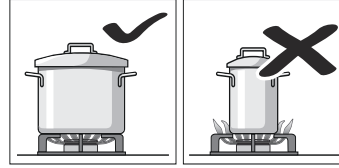

Her brülör için uygun ebatta kaplar kullanınız. Büyük brülörde küçük kaplar kullanmayınız. Alev, kapların yan taraflarına ulaşmamalıdır.

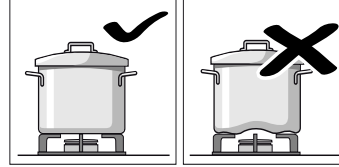

Pişirme tezgahı üzerine dengesizlik oluşturacak biçimi bozulmuş kaplar koymayınız. Kaplar devrilebilir. Yalnızca tabanı düz ve kalın olan kapları kullanınız.

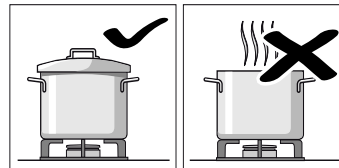

Kapaksız veya kapak yarı aralık olarak pişirmeyiniz. Enerjiyi boşa harcarsınız.

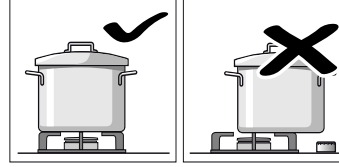

Kabı tam olarak brülör üzerinde ortalayınız, bir tarafına ağırlık vermeyiniz. Aksi durumda devrilebilir. Büyük kapları kumanda düğmelerinin yakınındaki brülörlere koymayınız. Aşırı sıcaktan dolayı hasara neden olabilir.

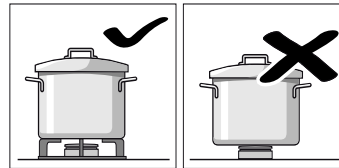

Kapları asla doğrudan brülörün üzerine değil, mutlaka ızgara üzerine yerleştiriniz. Cihazı çalıştırmadan önce, ızgaraların ve brülör kapaklarının doğru yerde olduğundan emin olunuz.

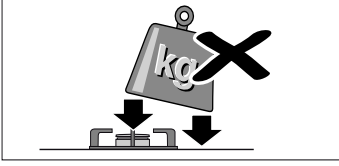

Pişirme tezgahındayken kapları dikkatli bir şekilde tutunuz. Pişirme tezgahına darbe gelmesine engel olunuz ve üzerine ağırlık yerleştirmeyiniz.

Piştirme tablosu



Aşağıdaki tablo, farklı yemekler için optimum piştirme kademelerini ve piştirme sürelerini içerir. Bilgiler, dört kişi için referans değerlerdir.

Piştirme süreleri ve piştirme kademeleri, yiyeceklerin türüne, ağırlığına ve kalitesine göre değişebileceği gibi piştirme kabının malzemesine de bağlıdır. Bu nedenle sapmalar mümkündür.







Her zaman uygun büyüklükte kap kullanınız ve kabı, brülörü ortalarak yerleştiriniz. Piştirme kabı çapına ilişkin bilgilere bakınız. → "Uygun kaplar"

Tabloya ilişkin bilgiler

Her yemeğin hazırlanışı bir veya iki adımdan oluşur. Her adımda aşağıdaki konulara ilişkin bilgiler mevcuttur:

-  Piştirme yöntemi
-  Piştirme kademesi
-  Dakika cinsinden süre







Tabloda belirtilen piştirme yöntemleri

-  Kaynatma
-  Piştirmeye devam edilmesi
-  Dödüklü tencerede basınç oluşumu
-  Dödüklü tencerede basıncın korunması
-  Güçlü kızartma
-  Hafif kızartma
-  Eritme
- * Kapaksız
- ** Sürekli karıştırınız

Bilgi: Bu sembolleri cihaz üzerinde bulamazsınız. Bunlar, farklı piştirme yöntemleri için yönlendirme amaçlıdır.

Tabloda farklı brülörler üzerinde yemekleri piştirmek için gerekli veriler mevcuttur. Tavsiye edilen seçenek, birinci brülördür. Modele genel bakış kısmında ocaktaki tüm brülörler açıklanır. → Sayfa 2

Örnek:

















































Yemek Brülörler	Dakika olarak toplam süre	Adım 1	Adım 2
Çorbalar, kremalı çorbalar			
Balık çorbası			
Büyük	12-17	 8 7-9	 1 5-8
Normal	17-22	 8 11-13	 1 6-9
Wok	10-15	 9 6-8	 4 4-7

Bu örnekte hızlı ocak, normal ocak ve wok ocak gözü yardımıyla balık çorbasının piştirilmesi gösterilmektedir.





































Hızlı ocak (önerilen seçenek) için toplam piştirme süresi 12 ile 17 dakika arasındadır.

- Adım 1: Kaynatma. Piştirme kademesi 8 ile 7-9 dakika kaynatınız.
- Adım 2: Piştirme. Piştirme kademesi 1 ile 5-8 dakika piştiriniz.

Önerilen diğer bir brülörü kullanmak istediğinizde aşağıdaki yöntemi kullanınız.

Yemek Brülörler	Dakika olarak toplam süre	Adım 1	Adım 2
Çorbalar, kremalı çorbalar			
Balık çorbası			
Büyük	12-17	 8 7-9	 1 5-8
Normal	17-22	 8 11-13	 1 6-9
Wok	10-15	 9 6-8	 4 4-7
Kabak kreması, borç çorbası			
Büyük	30-35	 9 10-12	 5 20-23
Normal	45-50	 9 15-17	 6 30-33
Wok	25-30	 9 8-10	 2 17-20
Minestrone (sebze çorbası)			
Büyük	47-52	 9 10-12	 5 37-40
Normal	57-62	 9 10-12	 6 47-50
Wok	43-48	 8 8-10	 3 35-38
Makarna ve piriç			
Spagetti			
Büyük	18-22	 * 9 8-10	 6 10-12
Normal	20-24	 * 9 10-12	 7 10-12
Wok	18-22	 * 8 8-10	 6 10-12
Piriç			
Büyük	17-22	 9 5-7	 2 12-15
Normal	18-23	 9 7-9	 6 11-14
Wok	15-20	 8 4-6	 2 11-14
Ravioli			
Büyük	9-14	 9 4-6	 6 5-8
Normal	17-22	 8 12-14	 8 5-8
Wok	10-15	 8 5-7	 8 5-8
Sebze ve baklagiller			
Haşlanmış patates (püre, patates salatası)			
Büyük	23-28	 9 8-10	 5 15-18
Normal	25-30	 9 10-12	 6 15-18
Wok	25-30	 7 11-13	 5 14-17
Humus (nohut püresi)			
Büyük	50-55	 9 10-12	 4 40-43
Normal	52-57	 9 12-14	 5 40-43
Wok	47-52	 7 10-12	 5 37-40

Yemek Brülörler	Dakika ola- rak toplam süre	Adım 1	Adım 2
Mercimek			
Büyük	40-45	 9 8-10	 9 32-35
Normal	50-55	 9 18-20	 6 32-35
Wok	45-50	 6 20-22	 4 25-28
Sebze kızartma			
Büyük	12-17	 * 7 6-8	 * 6 6-9
Normal	15-20	 * 8 8-10	 * 7 7-10
Wok	11-16	 * 7 6-8	 * 5 5-8
Taze sebze sote**			
Wok	6-8	 * 9 6-8	
Büyük	6-8	 * 9 6-8	
Patates kızartması			
Wok	15-20	 * 7 15-20	
Büyük	15-20	 * 9 15-20	
Normal	25-30	 * 9 25-30	
Yumurta			
Şakşuka			
Normal	15-20	 9 10-12	 4 5-8
Büyük	13-18	 8 7-9	 3 6-9
Wok	15-20	 6 11-13	 4 4-7
Omlet (1 porsiyon)			
Normal	3-5	 * 8 3-5	
Büyük	2-4	 * 9 2-4	
Wok	2-4	 * 5 2-4	
İspanyol tortillası			
Büyük	25-30	 * 9 25-30	
Wok	18-23	 * 9 18-23	
Soslar			
Beşamel sosu**			
Normal	10-15	 * 5 2-4	 * 5 8-11
Wok	3-8	 * 5 1-2	 * 5 2-6
Büyük	3-8	 * 5 1-2	 * 5 2-6
Küflü peynirli sos**			
Normal	3-5	 * 7 3-5	
Büyük	3-5	 * 5 3-5	
Napoliten sos			
Normal	18-23	 * 6 2-4	 * 4 16-19
Wok	13-18	 * 7 1-3	 * 5 12-15
Büyük	15-20	 * 8 1-3	 * 6 14-17
Carbonara sosu			
Normal	10-15	 * 6 5-7	 * 3 5-8
Büyük	8-13	 * 5 4-6	 * 3 4-7

Yemek Brülörler	Dakika ola- rak toplam süre	Adım 1	Adım 2
Balık			
Roma usulü barlam balığı			
Büyük	5-10	 * 8 5-10	
Normal	8-13	 * 9 8-13	
Wok	4-9	 * 6 4-9	
Fırınlanmış somon			
Büyük	5-10	 * 7 2-4	 1 3-6
Normal	5-10	 * 8 2-4	 1 3-6
Wok	7-12	 * 8 2-4	 1 5-8
Midye			
Büyük	5-7	 9 5-7	
Wok	4-6	 9 4-6	
Normal	10-12	 9 10-12	
Et			
Ördek göğsü (1 adet)			
Normal	6-8	 * 7 6-8	
Büyük	9-11	 * 7 9-11	
Wok	6-8	 * 5 6-8	
Beef Strogonof			
Büyük	8-13	 * 9 8-13	
Wok	5-10	 * 8 5-10	
Normal	12-17	 * 9 12-17	
Tavuk şnitzel (8 tavuk göğüs filetosu)			
Büyük	7-12	 * 9 2-4	 * 6 5-8
Wok	7-12	 * 9 2-4	 * 6 5-8
Normal	7-12	 * 9 7-12	
Kıyma (etli börek, köfte, bolonez sos)			
Büyük	15-20	 * 8 15-20	
Normal	20-25	 * 9 20-25	
Wok	15-20	 * 6 15-20	
Hazır ürünler			
Donmuş kroket (16 adet) Donmuş balık kroket (12 adet)			
Büyük	6-10	 8 6-10	
Wok	5-9	 8 5-9	
Normal	8-12	 8 8-12	
Sosis (12 adet)			
Büyük	5-10	 9 1-3	 7 4-7
Normal	7-12	 9 7-12	
Wok	5-10	 9 1-3	 7 4-7
Haşlanmış sosis (12 adet)			
Normal	8-13	 9 8-13	
Wok	9-14	 4 9-14	
Büyük	7-12	 7 7-12	

Yemek Brülörler	Dakika olarak toplam süre	Adım 1		Adım 2	
					
Hamburger (4 adet)					
Büyük	4-9	 *	9 1-3	 *	7 3-6
Wok	4-9	 *	9 1-3	 *	7 3-6
Normal	5-10	 *	9 1-3	 *	8 4-7
Dondurulmuş sebze**					
Büyük	7-12	 *	9 7-12		
Wok	5-10	 *	9 5-10		
Normal	12-17	 *	9 12-17		
Pizza (20 cm çap)					
Wok	4-8		1 4-8		
Büyük	16-20		1 16-20		
Normal	20-25		1 20-25		
Tatlılar					
Sütlü**					
Normal	30-35	 *	8 9-11	 *	4 21-24
Wok	35-40	 *	7 11-13	 *	1 24-27
Sütlü çikolata					
Normal	16-20	 *	1 16-20		
Krep (4 adet)					
Büyük	17-22	 *	7 1-3	 *	5 16-19
Wok	8-13	 *	7 1-3	 *	4 7-10
Normal	20-25	 *	8 1-3	 *	6 19-22
Ekmecli puding					
Büyük	25-30		9 10-12		6 15-18
Wok	23-28		9 8-10		7 15-18
Normal	27-32		9 10-12		7 17-20
İspanyol pudingi**					
Büyük	3-8	 *	5 3-8		
Normal	8-13	 *	5 8-13		
Wok	3-8	 *	2 3-8		
Kuru pasta (benmari usulü)					
Büyük	35-40		9 35-40		
Wok	40-45		9 40-45		
Normal	45-50		9 45-50		

Piştirme ipuçları

- Kremalı çorbaları ve baklagilleri piştirme sırasında düdüklü tencere kullanınız. Piştirme süresi belirgin biçimde azalır. Bir düdüklü tencere kullanıyorsanız üreticisinin talimatlarına uyunuz.
- Patates ve pirinç piştirirken her zaman tencerenin kapağını kapatınız. Piştirme süresi böylece belirgin biçimde azalır.

- Tencere yemeklerinde önce yağı ısıtınız. Kızartmaya başladıktan sonra gerekirse piştirme kademesini ayarlayarak sıcaklığı sabit tutunuz. Daha sonraki porsiyonları hazırlamak için piştirme sıcaklığına yeniden ulaşılan kadar bekleyiniz. Yiyecekleri düzenli aralıklarla çeviriniz.

Temizlenmesi ve bakıma tabi tutulması

Temizlik

Cihaz soğuduktan sonra sünger, sabun ve su ile temizleyiniz.

Her kullanımdan sonra, soğumalarının ardından ilgili brülör elemanlarının yüzeyini temizleyiniz. Ne kadar az da olsa yüzey üzerinde artık (taşmış yemek, yağ damlaları vb.) bırakılması halinde, yüzeyin üzeri kaplanacak ve sonrasında bu katmanın temizlenmesi daha zor olacaktır. Ateşin doğru yanabilmesi için delik ve olukların temiz olması gerekir.

Bazı kapların hareketi ızgaralar üzerinde metal izleri bırakabilir.

Brülörleri ve ızgaraları sabunlu su ile temizleyiniz ve metal olmayan bir fırça ile fırçalayınız.

ızgaralar lastik tıpalarla yerleştirilmiş ise temizlerken dikkatli olunuz. Tıpalı sökülebilir ve ızgara piştirme tezgahını çizebilir.

Her zaman brülörleri ve ızgaraları tamamen kurutunuz. Piştirme işleminin başında su damlaları veya nemli bölgeler emayenin bozulmasına yol açabilir.

Brülörleri temizledikten ve kuruladıktan sonra, brülör kapaklarının alev dağıtıcılarının üzerine doğru bir şekilde yerleştirildiğinden emin olunuz.

Dikkat!

- Cihazın temizlenmesi sırasında kumanda elemanlarını çıkarmayınız. Cihazın neme maruz kalması hasara neden olabilir.
- Buharlı temizleme makinelerini kullanmayınız. Piştirme tezgahı zarar görebilir.
- Piştirme tezgahı üzerinde kalan yemek artıklarını çıkarmak için asla yanıcı ürünler, tel bezler, kesici aletler, bıçak vb. kullanmayınız.
- Brülör kapakları ile cam levha birleşimlerini, metalik yüzeyleri, varsa cam ya da alüminyum levhaları temizlemek için spatula veya benzeri şeyler kullanmayınız.

Bakım

Taşan sıvıları anında temizleyiniz. Böylece yemek artıklarının yapışmasını önleyebilirsiniz ve gereksiz yere güç sarf etmezsiniz.

Çizilme ihtimali yüzünden asla tavaları yüzey üzerinde kaydırmayınız. Buna ek olarak, camın üzerine ağır veya sert cisimleri düşürmemeye dikkat ediniz. Tencerenin hiçbir parçasını çarpmayınız.

Kum tanecikleri (örneğin temizlenen meyvelerden ve sebzelerden gelebilecek olanlar) cam yüzeyi çizebilir.

Erimiş şeker veya çok fazla şeker içeren yemekler pişirme bölümüne döküldükleri anda cam kazıma aleti ile çıkarılmalıdır.

? Arıza halinde ne yapmalı?

Beklenmeyen durumlar bazen kolaylıkla çözülebilir. Teknik Servisi aramadan önce aşağıdaki önerileri dikkate alınız:

Arıza	Olası neden	Çözüm
Genel elektrik sistemi çalışmıyor.	Arızalı sigorta.	Ana sigorta kutusunu kontrol ediniz ve sigorta arızalıysa değiştiriniz.
	Otomatik sigorta attı veya şalter indi.	Genel kumanda panosunda ana sigortanın veya şalterin atıp atmadığını kontrol ediniz.
Otomatik çakmak çalışmıyor.	Bujiler ile brülörler arasında yemek veya temizleyici artığı kalmış olabilir.	Buji ve brülör arasındaki boşluk temiz olmalıdır.
	Brülörler ıslak olabilir.	Brülör kapaklarını dikkatlice kurulayınız.
	Brülör kapakları düzgün yerleştirilmemiş olabilir.	Kapakların düzgün yerleştirildiğinden emin olunuz.
	Cihaz topraklanmamış, kötü bir bağlantı yapılmış veya topraklaması hatalı.	Bir elektrik teknisyeniyle temasa geçiniz.
Brülör alevi eşit değil.	Brülör parçaları düzgün yerleştirilmemiş olabilir.	Parçaları ilgili brülörlere doğru şekilde yerleştiriniz.
	Brülör boşlukları kirli.	Brülör boşluklarını temizleyiniz.
Gaz akışı normal gözüküyor veya gaz çıkmıyor.	Gaz geçişi gaz valfleri tarafından engellenmiş.	Tüm gaz valflerini açınız.
	Gaz, gaz tüpünden geliyorsa tüpün boş olmadığından emin olunuz.	Gaz tüpünü değiştiriniz.
Mutfakta gaz kokusu var.	Bir vana açık kalmış olabilir.	Vanaları kapatınız.
	Gaz tüpünün kötü bağlanması.	Bağlantının doğru olduğundan emin olunuz.
	Olası gaz kaçağı.	Genel gaz anahtarını kapatın, ortamı havalandırın ve kurulumu gözden geçirmesi ve onaylaması için derhal bir yetkili kurulum teknisyenine haber veriniz. Kurulumda veya cihazda hiç gaz kaçağı olmadığından emin olana kadar cihazı kullanmayınız.
Düğme bırakıldıktan sonra brülör hemen kapanıyor.	Kumanda düğmesine yeterince uzun süre basılmamış olabilir.	Brülörü yakınız ve kumanda düğmesini birkaç saniye daha basılı tutunuz.
	Brülör boşlukları kirli.	Brülör boşluklarını temizleyiniz.

Yetkili servisin çağırılması

Teknik Servisimize ihtiyacınız varsa cihazın ürün numarasını (E-Nr.) ve üretim numarasını (FD) vermeniz gerekecektir. Bu bilgiyi pişirme tezgahının iç kısmında yer alan özellikler tablosunun üzerinde ve kullanım kılavuzunun etiketinde bulabilirsiniz.

Kullanım ömrü :10 yıldır (Ürünün fonksiyonunu yerine getirebilmesi için gerekli yedek parça bulundurma süresi)

Arızalarda onarım siparişi ve danışma

TR 444 6688
Çağrı merkezini sabit hatlardan aramanın bedeli şehir içi ücretlendirme, Cep telefonlarından ise kullanılan tarife göre değişkenlik göstermektedir.

Üreticinin yetkisine güveniniz. Böylelikle gerekli onarım çalışmalarının, cihazınızın orijinal yedek parçalarına sahip, eğitilmiş servis teknisyenleri tarafından yapıldığından emin olabilirsiniz.

Garanti koşulları

Beklentilerimizin aksine, cihazda herhangi bir arıza meydana gelirse veya ihtiyaçları öngörülen kalitede karşılayamazsa lütfen bunu en kısa sürede bize bildiriniz. Garantinin geçerli olması için cihaza müdahale edilmemiş ve yanlış kullanılmamış olması gerekir.

Bu cihaz için uygulanan garanti koşulları, şirketimizin, cihazın satın alındığı ülkedeki temsilciliği tarafından belirlenir. Satış noktalarından ayrıntılı bilgi edinebilirsiniz. Garantinin geçerli olması için satış belgesinin bulundurulması gerekir.

Her türlü değişiklik hakkı saklıdır.

Çevre koruma

Özellikler tablosunda  sembolü görülüyorsa aşağıdaki göstergelere dikkat ediniz.

Çevre kurallarına uygun şekilde imha edilmesi

Ambalaj malzemesini çevre kurallarına uygun şekilde imha ediniz.



Bu cihaz, ömrünü doldurmuş elektrikli ve elektronik cihazlar ile ilgili Avrupa yönetmeliği 2012/19/EG'ye (waste electrical and electronic equipment – WEEE) uygun şekilde işaretlenmiştir.

Bu yönetmelik, eski cihazların geri alımı ve değerlendirilmesi ile ilgili AB-çapındaki uygulamaların çerçevesini belirtmektedir.

Cihazınızın ambalajı, nakliye sırasında etkin korumayı garanti etmek açısından çok gerekli olan malzemelerden üretilmiştir. Bu malzemeler tamamen geri dönüşebilir ve böylece çevreye verilen zarar azaltılmaktadır. Sizleri de aşağıdaki tavsiyelere uyararak çevrenin korunmasına katkıda bulunmaya davet ediyoruz:

- ambalajı uygun geri dönüşüm kutusuna atınız,
- cihazı hurdaya çıkarmadan önce kullanılmaz hale getiriniz. Bulduğunuz yerin yerel yönetimine, geri dönüşebilen malzemelerin toplandığı en yakın merkeze danışınız ve cihazınızı oraya ulaştırınız,
- kullanılmış yağı lavaboya dökmeyiniz. Yağı kapalı bir kaba koyarak çöp toplama noktasına veya bir çöp konteynerine bırakınız (kontrollü bir çöplüğe ulaşacaktır; bu en iyi çözüm olmasa da bu sayede suyun kirlenmesini engelleriz).



BSH Electrodomésticos España S.A.
Ronda del Canal Imperial de Aragón, 18-20
Parque empresarial Pla-Za 50197 Zaragoza, SPAIN

www.balay.es



9001127180
960301(A)
el, es, pt, tr