



SIEMENS



Washing machine

WM..U...

siemens-home.bsh-group.com/welcome

en Instruction Manual and Installation Instructions

Register
your
product
online

Your new washing machine

You have chosen a Siemens washing machine.

Please take a few minutes to read and become familiar with the advantages of your washing machine.

To meet the high quality demands required by Siemens, every washing machine that leaves our factory is carefully checked to ensure that it functions correctly and is in perfect condition.

For more information on our products, accessories, replacement parts and services, see our website www.siemens-home.bsh-group.com or contact our after-sales service centres.

If the operating and installation instructions describe different models, any differences will be pointed out at the relevant points in the text.



Read these operating and installation instructions before switching on the washing machine.

Display rules

Warning!

This combination of symbol and signal word indicates a possibly dangerous situation. Not heeding the warning can cause death or injuries.

Caution!

This signal word indicates a possibly dangerous situation. Not heeding the caution can cause property and/or environmental damage.

Note/tip

Information about the optimum use of the appliance/any other useful information.

1. 2. 3. / a) b) c)

The steps are represented by numbers or letters.

■ / -

Lists are represented by a small box or a dash.

Contents

Intended use 4

Safety instructions 5

Electrical safety	5
Risk of injury	5
Safety for children	6

Environmental protection 7

Packaging/used appliance	7
Tips on economical use	7

Getting to know the appliance . 8

Appliance	8
Control panel	9
Touch-Display	10

Laundry 11

Preparing the laundry	11
Sorting laundry	11
Starching	11
Dyeing/bleaching	11



Detergent 12

Correct selection of detergent	12
Saving energy and detergent	12

Programme default settings ... 13

Temperature	13
Spin speed	13
Finish in	13
i-Dos setting	14

Additional programme settings 14

 Speed	14
 Eco	14
Prewash	15
Water plus	15
Easy iron	15
Soaking	15
Rinse plus	15
Memory programme	15
Silent wash	15

Operating the appliance 16

Preparing the appliance	16
Switching on the appliance/selecting a programme	16
Changing the programme default settings	16
Selecting the programme additional settings	17
Placing laundry into the drum	17
Measuring and adding detergent and care products	17
Starting the programme	17
Childlock	18
Adding/removing laundry	18
Changing the programme	18
Cancel the programme	18
Programme end during rinse hold	19
Programme end	19
Removing laundry/switching off the appliance	19

Intelligent dosing system 20

Intelligent dosing system in the detergent drawer	20
Initial use/filling the dispensers	20
Everyday use	21
Basic settings	21
Manual dosage	22

Appliance settings 23

Automatic switch-off	23
Basic settings	23

Sensors 24

Unbalanced load detection system	24
Aqua-Sensors	24

Cleaning and maintenance ... 25

Appliance housing/control panel	25
Drum	25
Descaling	25
i-Dos detergent draw and its housing	25
Drain pump is blocked	27

The drain hose at the siphon is blocked 27
 Filter in the water supply is blocked 28

 **Faults and what to do about them** 28

Emergency release 28
 Information on the Touch-Display . . 29
 Faults and what to do about them . . 30

 **After-sales service** 32

 **Technical data** 32

 **Positioning and connecting** . . 33

Standard accessories 33
 Safety instructions 33
 Installation surface 34
 Installation on a base or a wooden joist floor 34
 Installation on a platform with drawer 34
 Installing the appliance in a kitchenette 34
 Removing the transport locks 34
 Hose and cable lengths 35
 Water inlet 35
 Water outlet 36
 Alignment 37
 Electrical connection 38
 Before washing for the first time . . 38
 Transportation 39

 **Aqua-Stop warranty** 39

 **Intended use**

- For private domestic use only.
- The appliance is suitable for appliance-washable fabrics and hand-washable wool in detergent solution.
- To be operated with cold mains water and standard detergents and care products which are suitable for use in front-loading appliance. Do not use detergents for hand wash.
- When measuring out the amount of all detergents, additives, care products and cleaning agents, always follow the manufacturer's instructions.
- The appliance may be used by children over the age of 8 years and by persons with reduced physical, sensory or mental capacity or by persons with a lack of experience or knowledge if they **are supervised** or have been **instructed** by a responsible person. Children must not carry out any cleaning or maintenance work without supervision.
- Keep children under the age of 3 years away from the appliance.
- This appliance is intended for use up to a maximum height of 4000 metres above sea level.
- Keep pets away from the appliance.

Before operating the appliance: Read the installation and operating instructions and all other information enclosed with the appliance, and use the appliance accordingly. Retain the documents for subsequent use or for subsequent owners.

Safety instructions

Electrical safety

Warning

Risk of death!

There is a risk of electric shock if you touch live components.

- Never touch or hold the mains plug with wet hands.
- Only pull out the mains cable by the plug and never by the cable, as this could damage it.
- The appliance must be grounded.
Electrical connection
→ *Page 38*

Risk of injury

Warning

Risk of injury!

- If the appliance is lifted by protruding components (e.g. the appliance door), the components may break off and cause injuries.
Do not lift the appliance by protruding parts.
- If you climb onto the appliance, the worktop may break and cause injuries.
Do not climb onto the appliance.
- If you lean/sit on the opened appliance door, the appliance may tip over and cause injuries.
Do not lean on the appliance door when it is open.

- Reaching into the drum while it is still turning may cause hand injuries.
Do not reach into the drum when it is turning.
Wait until the drum has stopped turning.

Warning

Risk of scalding!

When you are washing at high temperatures, there is a risk of scalding if you come into contact with hot detergent solution (e.g. when draining hot detergent solution into a washbasin).
Do not reach into the hot detergent solution.

Safety for children

Warning

Risk of death!

- There is a risk of death or injury if children play with the appliance.
 - Do not leave children unattended near the appliance.
 - Do not let children play with the appliance.
- Children may lock themselves in appliances, putting their lives at risk. When appliances have reached the end of their service life:
 - Unplug the mains plug.
 - Cut through the mains cable and remove it, along with the plug.
 - Destroy the lock on the appliance door.

Warning

Risk of suffocation!

Children may become wrapped in packaging/film or packing parts if allowed to play with them, or they may pull them over their heads and suffocate. Keep packaging, film and packaging parts out of the reach of children.

Warning

Risk of poisoning!

Detergents and care products may be poisonous if consumed.

Keep detergents and care products out of the reach of children.

Warning

Eye/skin irritation!

Detergents and care products may cause irritation if they come into contact with the eyes or skin.

Keep detergents and care products out of the reach of children.

Warning

Risk of injury!

When you wash at high temperatures, the glass in the appliance door becomes hot. Do not let children touch the hot appliance door.



Environmental protection

Packaging/used appliance



Dispose of packaging in an environmentally-responsible manner.

This appliance is labelled in accordance with European Directive 2012/19/EU concerning used electrical and electronic appliances (waste electrical and electronic equipment - WEEE).

The guideline determines the framework for the return and recycling of used appliances as applicable throughout the EU.



Tips on economical use

- Always fill the appliance with the maximum amount of laundry for each programme.
Overview of programmes →: Supplementary sheet for the operating and installation instructions.
- Wash normally soiled laundry without pretreating.
- For light and normal soiling in laundry, you can save energy and detergent.
- Dosing the detergent using the **intelligent dosing system** (i-Dos) helps to save both detergent and water.
- The selectable temperatures apply to the care labels on the textiles. The temperatures in the appliance may deviate from this so that you get the optimum mix of energy-saving and washing results.
- **Energy-saving mode:** If the appliance is not operated for a prolonged period (approx. 5 minutes), the Touch-Display lighting goes out before the programme starts and when the programme has ended to save energy, power button flashes. Touch any area of Touch-Display to activate the lighting. When the programme is running, most of the Touch-Display lighting goes out. Touch any area of Touch-Display to activate the lighting.
- **Automatic switch off:** If the appliance is not operated for a prolonged period (approx. 15 minutes), it may automatically switch off before the programme starts and when the programme has ended to save energy. Press the power button ① again to switch on the appliance.
- If the washing will be dried in a dryer, select the spin speed according to the dryer manufacturer's instructions.

Getting to know the appliance

Appliance



-  Detergent drawer
-  Operating/Touch-Display
-  Loading door
-  Service flap

Control panel

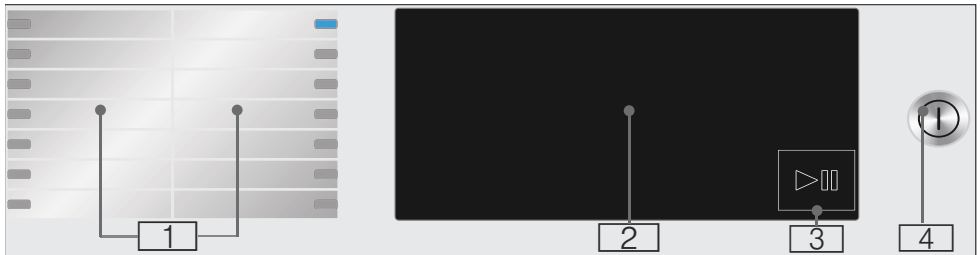

- 1** Programmes that can be selected
 Overview of programmes
 →: Supplementary sheet for the operating and installation instructions.
- 2** Touch-Display
- 3** Start/Pause button
 Touch ▷|| button to start, interrupt (e.g. reload washing) and cancel the programme.
- 4** Power button
 Press the ⏻ button to switch the appliance on/off.

en Getting to know the appliance

Touch-Display

Programme default settings

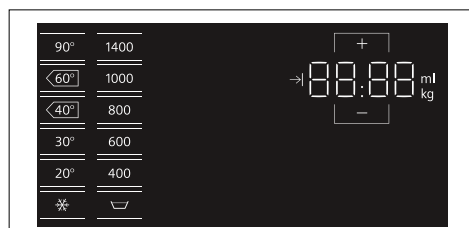

Display	Setting	Description
* - 90°C	Temperature	Temperature that can be set in °C * = cold
▽, 400 - 1400*	Spin speed	Spin speed in rpm (revolutions per minute) ▽ = Rinse hold
2:30*	Programme remaining time	Programme remaining time depends on the programme selection in h:min (hours:minutes)
0.5 - 24 h	"Finish in" time	Programme ends after ... h (h = hours)
9.0* kg	Maximum load	Recommended load in kg
* Depending on the selected programme		

additional programme settings

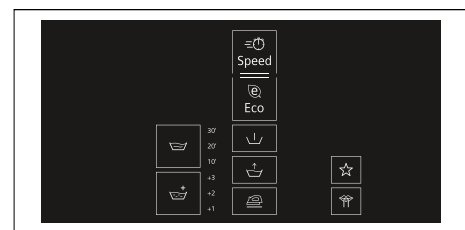

Display	Setting
▽	Soaking
▽+	Rinse plus
≡⌚	Speed
⊙	Eco
▽↓	Prewash
▽+	Water plus
🧺	Easy iron
☆	Memory programme
🔇	Silent wash/basic settings

Status indicators for the programme progress (programme sequence)

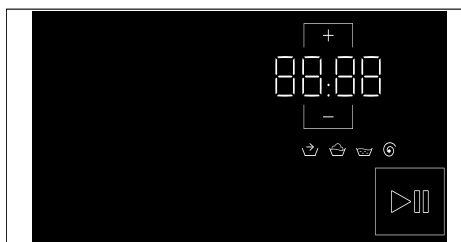

Display	Setting
▶⏸	Start/Pause button
🧺	Pretreatment
🧺	Wash
▽	Rinse
⌚	Spin/Drain
End	Programme end

Laundry

Preparing the laundry

Caution!

Damage to the appliance/fabrics

Foreign objects (e.g. coins, paper clips, needles, nails) may damage the laundry or components in the appliance.

Therefore, note the following tips when preparing your laundry:

- Empty any pockets.

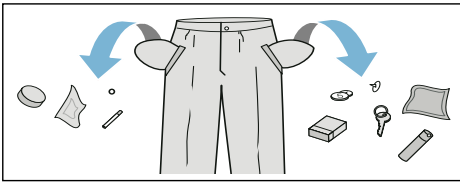



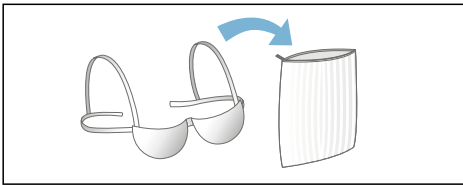







- Check for metal items (paper clips, etc.) and remove them.
- Wash delicates in a laundry bag (tights, underwired bras, etc.).



- Remove curtain fittings or place curtains in a laundry bag.
- Close any zips, button up any cover buttons.
- Brush sand out of pockets and collars.



Sorting laundry

- Soiling
Wash laundry with the same level of soiling together.
You can find examples of levels of soiling on
 - **Light:** Do not pretreat, select the  **Speed** setting if necessary
 - **Normal**
 - **Heavy:** Load less laundry, pretreat the laundry if necessary.

- **Stains:** Remove/pretreat stains while they are fresh. First, dab the stain with soapy water/do not rub. Then wash the items of laundry with the appropriate programme. Stubborn/dried-in stains can sometimes only be removed with several washes.
- Symbols on the care labels
The numbers in the symbols indicate the maximum washing temperature which may be used.
 - : Suitable for a normal washing process; e.g.  **Cottons** programme.
 - : A gentle washing process is required; e.g.  **Easy-Care** programme.
 - : An especially gentle washing process is required; e.g.  **Delicates/Silk** programme.
 - : Suitable for washing by hand; e.g.  **Wool**  programme.
 - : Do not wash the laundry in the appliance.

Starching

Note: Laundry should not be treated with fabric softener.

1. Switch on the appliance.
2. Select the  **Rinse/Spin** .
3. Manually add the dosage of liquid starch into the left-hand dispenser (if required, clean it beforehand) in accordance with the manufacturer's instructions.
4. Touch the  button.

Dyeing/bleaching

Dye should only be used in normal household quantities. Salt may damage stainless steel. Always follow the dye manufacturer's instructions.

Do **not** use the appliance to bleach clothes.

Detergent

Correct selection of detergent

The care label is crucial for selecting the correct detergent, temperature and treatment of the laundry. → See also www.sartex.ch

If you visit www.cleanright.eu, you will find further information on detergents, care products and cleaning agents for domestic use.

- **Standard detergent with optical brighteners**
Suitable for boil-washable white laundry made from linen or cotton
Programme: Cottons/
cold - max. 90 °C
- **Detergent for colours without bleach or optical brighteners**
Suitable for coloured laundry made from linen or cotton
Programme: Cottons/
cold - max. 60 °C
- **Detergent for colours/delicates without optical brighteners**
Suitable for coloured laundry made from easy-care fibres, synthetic fibres
Programme: Easy-Care/
cold - max. 60 °C
- **Detergent for delicates**
Suitable for delicate, fine fabrics, silk or viscose
Programme: Delicate/Silk/
cold - max. 40 °C
- **Detergent for woollens**
Suitable for wool
Wool programme/
cold - max. 40 °C

Saving energy and detergent

For light and normal soiling, you can save energy (lower washing temperature) and detergent.

Saving	Soiling/note
 <p>Reduced temperature and detergent quantity as per the recommended dosage</p> <p>Temperature as per the care label and detergent quantity as per the recommended dosage for heavy soiling</p>	<p>Light No visible dirt or stains. Clothing has taken on some body odour, e.g.:</p> <ul style="list-style-type: none"> ■ Light summer/sports clothing (worn for a few hours) ■ T-shirts, shirts, blouses (worn for up to one day) ■ Guest bed linen and hand towels (used for one day)
	<p>Normal Visible dirt or a few light stains, e.g.:</p> <ul style="list-style-type: none"> ■ T-shirts, shirts, blouses (sweat soaked, worn a few times) ■ Towels, bedding (used for up to one week)
	<p>Heavy Dirt and/or stains clearly visible, e.g. tea towels, baby items, work clothing</p>

Note: When measuring the amount of all detergents/additives/care products and cleaning agents, please always check the manufacturer's instructions and information.

P+ Programme default settings

You can change the default settings for selected programmes. The settings can be changed even while the selected programme is running. The effects depending on the progress of the programme.

Temperature

(°C)

Depending on what stage the programme is in, you can change the temperature before and during the programme.

The maximum temperature that can be set depending on the model and the programme that has been selected.

Spin speed

(⊙)

Depending on what stage the programme is in, you can change the spin speed (in rpm; revolutions per minute) before and during the programme.

setting ☹: “Rinse hold” = no final spin. The laundry stays in the water after the final rinse.

You can select “Rinse hold” to prevent creasing if the laundry will not be taken out of the appliance immediately after the programme has ended.

To continue/end the programme
→ Page 19

The maximum speed that can be set depending on the model and the programme that has been selected.

Finish in

(→)

After selecting a programme, the programme duration is displayed, e.g. **1:51** (in h:min (hours:minutes)).

Before the programme starts, you can move the time at which the programme should be finished backwards, in increments of 30 minutes and up to a maximum of 24 h (h=hour).

To do this:

1. Select a programme (except **MyTime** programme).

The programme duration is displayed for the selected programme, e.g. **2:30** (hours:minutes).

2. Touch the **+** button repeatedly until the required number of hours is displayed.

Note: The setting values are increased using the **+** button, and decreased using the **-** button.

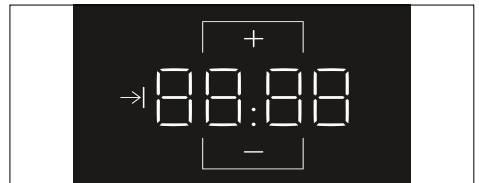

3. Touch the **▷|||** button.

After the programme starts, the selected time, e.g. **8 h** is displayed and counted down until the washing programme starts. The duration of the programme is then displayed.

Note: The length of the programme is automatically adjusted when the programme is running. Changes to the default programme settings or programme additional settings may also change the programme duration.

After the programme starts, and while the selected time is counting down, you can change this as follows:



1. Touch the **▷|||** button.
2. Touch **+** or **-** button to change the number of hours.
3. And touch the **▷|||** button again.

i-Dos setting

Your appliance has an intelligent dosing system for liquid detergent and fabric softener.

The appliance doses your detergent and fabric softener automatically in most programmes.

The following have been preset at the factory:

-  i-Dos: ∅
Detergent dosage for lightly soiled laundry
-  i-Dos: ∅∅
Fabric softener dosage for a medium level of softness

i-Dos for detergent

Adjustment values for the dosage quantity

- ∅ Light:
For lightly soiled laundry
- ∅∅ Medium:
For normally soiled laundry
- ∅∅∅ Heavy:
For particularly heavy soiling and/or staining
- off Automatic dosing deselected, manual dosage

You can change the settings for automatic detergent dosing before the washing programme starts and during prewash (if selected). Touch the  **i-Dos** for this.

You can find information on degrees of soiling on.

i-Dos for fabric softener

Adjustment values for dosage quantities

- ∅ Light:
For slightly soft laundry
- ∅∅ Medium:
For laundry with a medium level of softness
- ∅∅∅ Heavy:
For particularly soft laundry
- off Automatic dosing deselected

Depending on what stage the programme is in, you can change the settings for automatic detergent dosage. Touch the  **i-Dos** for this.

Additional programme settings

Note: You can find possible programme additional settings in the overview; these differ depending on the model.

By selecting additional settings, you can better adapt the washing process to your items of laundry.

The settings can be selected or deselected depending on the progress of the programme.

The button indicator lamps light up if a setting is activated.

The settings are not retained after the appliance is switched off.

Speed

()

Washing in a shorter time while achieving a washing result that is consistent with, but uses more energy than the selected programme without the  **Speed** setting.

Note: Do not exceed the maximum load.

Eco

()

Energy-optimised washing by reducing the temperature while achieving a washing result that is consistent with the selected programme without the  **Eco** setting.

Prewash



For heavily soiled laundry.

Notes

- If **intelligent dosage is selected**, the detergent will be dispensed automatically for the prewash and the main wash.
- For heavily soiled laundry, **medium** dosing is usually sufficient when selecting a programme with  (**Prewash**).
- If **dosing manually**, allocate detergent to the prewash and the main wash. Place detergent for the prewash in the drum and add washing powder for the main wash to the left-hand compartment.

Water plus



Increased water level, gentler treatment of the laundry.

Easy iron



Reduces creasing thanks to a special spin sequence followed by fluffing and reduced spin speed.

Note: The washing's residual moisture is increased.

Soaking



Before the main wash cycle starts, the washing remains for longer in the water to partially dissolve intensive soiling.

10'	10 minutes
20'	20 minutes
30'	30 minutes

Notes

- Put detergent in the drum.
- Load laundry of the same colour.

Rinse plus



Settings that can be selected:

+1	+ 1 rinse
+2	+ 2 rinses
+3	+ 3 rinses

Additional rinse cycles depending on the programme; longer programme length for particularly sensitive skin and/or for areas with very soft water.

Memory programme



You can save a selected programme with your favourite settings here.

To store:

1. Switch on the appliance.
2. Select a programme.
3. If required, change the programme default settings and/or select programme additional settings.
4. Touch and hold ☆ button for approx. three seconds.

The programme is saved if all of the settings flash briefly.

To use the saved programme, touch ☆ button briefly after you switch on the appliance.

To change the saved programme, touch and hold ☆ button again for approx. three seconds after selecting the new settings.

Silent wash



Reduced noise values thanks to special wash and spin cycle and deactivated end signal. Especially suitable for washing at night.

Note: Residual moisture of the washing is slightly increased. The spin result is may not satisfactory. You can select **Spin**  programme before hanging.



Operating the appliance

Preparing the appliance

The appliance was tested before delivery. To remove residual water from the test procedure, the first wash cycle should be run without laundry using the **Drum Clean** programme.

Before washing for the first time

→ Page 38

Notes

- Never switch on a damaged appliance!
- Inform customer service!

1. Insert mains plug.



Warning **Risk of death from electric shock!**

Risk of death if live parts are touched.

- Never pull out the mains plug by tugging the power cord.
- Insert/pull out the mains plug with dry hands only.

2. Turn the tap on.

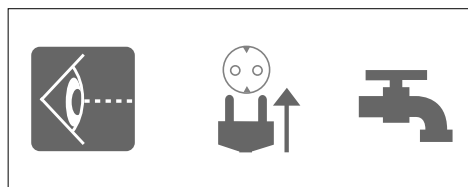

3. Open the appliance door.

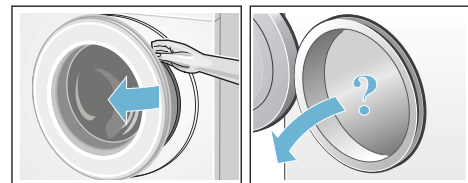

Switching on the appliance/ selecting a programme

Press the **Ⓛ** button till the indicator lamp lights up, release the button. The appliance is switched on.

The **Cottons** programme, which is preset at the factory, is then always displayed.

You can use this programme or select a different programme.

Note: If you have activated the childproof lock, you must deactivate it before you can set a programme.

Presettings and maximum load are indicated on the Touch-Display for the selected programme:

You can use the displayed presettings or adjust the selected programme optimally to the items of washing by changing the → "Programme default settings" on page 13 and/or selecting → "Additional programme settings" on page 14.

Changing the programme default settings

You can use the default settings or change them.

To do this, repeatedly select the corresponding button until the required setting is displayed.

The settings are activated without needing to be confirmed.

They are not saved when the appliance is switched off.

Programme default settings
→ Page 13

Overview of programmes →
Supplementary sheet for the operating
and installation instructions.

Selecting the programme additional settings

By selecting additional settings, you can better adapt the washing process to your items of laundry.

The settings can be selected or deselected depending on the programme progress.

The indicator lamp for the button lights up if a setting is activated.

The settings are not saved when the appliance is switched off.

Programme additional settings
→ *Page 14*

Overview of programmes →
Supplementary sheet for the operating and installation instructions.

Placing laundry into the drum

Warning **Risk of death!**

Items of laundry pretreated with cleaning agents that contain solvents, e.g. stain remover/cleaning solvent, may cause an explosion after being loaded into the appliance.

Hand-rinse these items of laundry thoroughly beforehand.

Notes

- Mix items of laundry of varying sizes. Laundry items of different sizes distribute themselves better during the spin cycle. Individual laundry items may cause an unbalanced load.
 - Observe the maximum specified load. Overfilling adversely affects the washing result and promotes creasing.
1. Unfold presorted laundry items and place them in the drum.
 2. Make sure that no items of laundry are trapped between the door and the rubber seal, and close the door.

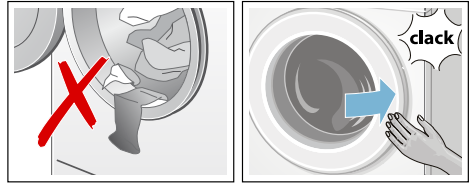

Measuring and adding detergent and care products

For the majority of programmes on your appliance, detergent and fabric softener are dosed automatically; it is a factory setting for these programmes and can be changed.

In addition to intelligent dosing, you can add cleaning aids (e.g. softener, bleach or stain remover) to the left-hand compartment, if necessary.

For programmes without intelligent dosing, or as required (in which case, set intelligent dosing to "off"), detergent can be added manually to the left-hand compartment.

Starting the programme

Select the  button. The indicator lamp lights up and the programme starts.

The **Finish in** is shown in the Touch-Display and counts down until the programme starts. After the washing programme has started, the programme duration is displayed. And the displays for the programme's progress light up.
→ *"Control panel" on page 9*

Note: Foam detection

If the symbol  also lights up in the Touch-Display, the appliance has detected too much foam during the wash cycle and automatically activated additional rinse cycles to remove the foam.

If you want to lock the programme to prevent it from being adjusted inadvertently, you can select the childproof lock.

Childlock

(🔒 3 sec)

You can lock the appliance to prevent the functions you have set from being changed inadvertently in the control panel.

To activate the childlock:

After the programme starts, touch and hold the 🔒 3 sec button for approx. three seconds. The display switches to full brightness.

If you touch the control panel while the childlock is activated, the 🔒 3 sec indicator will flash briefly and a signal will sound. The programme runs through to the end unchanged.

Note: When the programme ends, **End** is displayed. The door is closed. 🔒 3 sec indicator still lights up and 🔄 symbols remain on to remind you to deactivate the childlock.

To deactivate the childlock:

Touch and hold the 🔒 3 sec button until the indicator turns off.

Notes

- To remove the laundry at the end of the programme, deactivate the childlock.
- The childlock remains active, even once the appliance has been switched off.
- If the appliance is switched off while the programme is running and childlock is activated, the programme continues when the appliance is switched back on.

Adding/removing laundry

After starting the programme, you can add or remove laundry if necessary.

Touch the ▷ button. The appliance checks whether reloading is possible.

If the following appears on the Touch-Display:

- The symbol 🔄 disappears, reloading is possible.
- The symbol 🔄 lights up, reloading is not possible.

To continue the programme, touch the ▷ button. The programme continues automatically.

Notes

- Do not leave the door open for too long when adding laundry as water from the laundry may leak out.
- For safety reasons, the door remains locked when the water level or temperature is high, or while the drum is turning, and it is not possible to add laundry during this time.

Changing the programme

If you have started the wrong programme by mistake, you can change the programme as follows:

1. Touch the ▷ button.
2. Select another programme.
3. And touch the ▷ button again. The new programme starts from the beginning.

Cancel the programme

For programmes at high temperatures:

1. Touch the ▷ button.
2. To cool down laundry: Select 🔄 **Rinse/Spin** 🔄
3. And touch the ▷ button again.

For programmes at low temperatures:

1. Touch the ▷ button.
2. Select 🔄 **Rinse/Spin** 🔄
3. And touch the ▷ button again.

Programme end during rinse hold

The ▷||| button flashes on the Touch-Display, and the preset spin speed and remaining programme length are displayed for the selected programme.



Continue the programme by:

- Touch the ▷||| button or
 - Change the spin speed (if necessary) and then touch the ▷||| button again.
- Note:** If the water only needs to be drained, touch the ▷||| button approx. 1 minute after the programme starts, before the spin cycle begins. Then switch the appliance off. The programme is interrupted and the door lock is released. The laundry can be removed.

Programme end

End lights up on the Touch-Display and ▷||| and Ⓢ displays are off.

Removing laundry/switching off the appliance

1. Press the ① button till the indicator lamp turns off, release the button. The appliance is switched off.
 2. Open the door and remove the laundry.
 3. Turn off the tap.
- Note:** Not required for Aqua-Stop models.

Notes

- Do not leave any items of laundry in the drum. They may shrink in the next wash or discolour another item.
- Remove any foreign objects from the drum and the rubber seal – risk of rusting.
- Wipe the rubber seal dry.

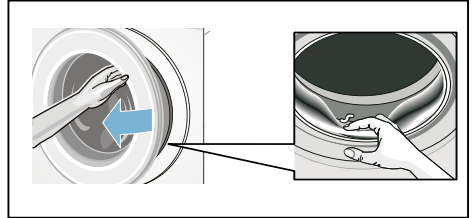



- Leave the door and detergent drawer open so that any residual water can evaporate.
- Always wait until the programme ends, as the appliance could still be locked. Then switch the appliance on and wait for it to unlock.

i-DOS Intelligent dosing system



Intelligent dosing system in the detergent drawer

i-Dos Intelligent Dosing system

Your appliance has an intelligent dosing system for liquid detergent and fabric softener.

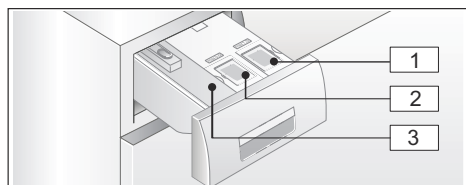
The i-Dos dispensers  and  in the detergent drawer are available for this purpose.



- 1 Dispenser  (1.3 l) for liquid detergent
- 2 Dispenser  (0.5 l) for fabric softener
- 3 Left-hand compartment for manual dosing

Depending on the selected programme and settings, the optimum quantity of detergent and/or fabric softener is dosed by the i-Dos dispensers.

Initial use/filling the dispensers

Refer to the manufacturer's instructions when choosing your detergent and fabric softener. We recommend the use of standard, universal and colour liquid detergents for all appliance-washable, coloured fabrics made of cotton or synthetic materials.

Notes

- Only use easy-pour liquid products that the manufacturer recommends adding to the detergent drawer.
- Do not mix different liquid detergents. If changing your liquid detergent (type, manufacturer, etc.), empty the dispenser completely and clean it.
- Do not use products containing solvents, caustic agents or volatile substances (e.g. bleach).
- Do not mix detergent and fabric softener.
- Do not use products that have expired or are highly congealed.
- To prevent drying out, do not leave the dispenser lids open for a long period of time.

Filling the dispensers:

The lids of the dispensers in the detergent drawer are marked with the following symbols:

-  Standard/universal detergent
-  Fabric softener

1. Open the detergent drawer.
2. Open the dispenser lid(s).
3. Add detergent and/or fabric softener. Do not fill above the **max.** marking.

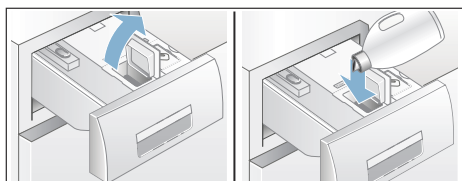

4. Close the lid(s).
5. Slowly push the detergent drawer in completely.

When the detergent drawer is fully pushed in, the display  goes out when the appliance is switched on.

Everyday use

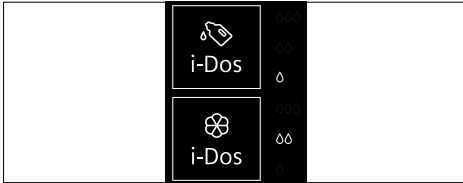

Displays:





- The display **lights up** if intelligent dosage has been selected for the dispenser.
- The display for the adjustment values, e.g. ΔΔ **flashes** if the fill level for the dispenser is below the minimum level when intelligent dosing has been selected.

(De)selecting intelligent dosage and adjusting the dosage strength:

The intelligent dosages for detergent and fabric softener are set at the factory for all programmes in which intelligent dosing can be used.

The dosage strength has been preset to Δ (lightly soiled laundry) for detergent  and to ΔΔ (medium level of softness) for fabric softener . It can be changed individually for each programme.

In addition to intelligent dosing, washing additives (e.g. stain remover) can be added manually via the left-hand compartment.

Note: The selection (on/off) and the selected dosage strength for  **i-Dos** and  **i-Dos** are saved for each programme until they are changed again, even if the appliance is switched off.

Topping up the detergent/ fabric softener:

If the display for the selected intelligent dosing flashes, this means that the amount of detergent or fabric softener in the dispenser is below the minimum fill level. The content is sufficient for approx. three washes.

The same detergent or fabric softener can be added at any time. If you change product/manufacturer, we recommend that you clean the dispensers first.

If required, adjust the basic dosage.

Basic settings

The basic dosages are:

- **For detergents** – based on the manufacturer's recommendation for average soiling and the respective water hardness.
- **For fabric softeners** – based on the manufacturer's recommendation for a medium level of softness.

Refer to the packaging label on your detergent/fabric softener or ask the manufacturer directly for this information.

To find out the hardness of your water supply, use a test strip or check with your water supplier.

My water hardness:



Below is an example of detergent dosages on a packaging label:

Degree of soiling → Water hardness ↓	light	normal	heavy	very heavy
soft/medium	55 ml	75 ml	120 ml	160 ml
hard/very hard	75 ml	95 ml	150 ml	180 ml

The default setting for the basic dosage is set specifically according to the area in which you live (e.g. 75 ml for detergent and 36 ml for fabric softener).

Set the basic detergent dosage according to the detergent's packaging label. Take your water hardness into consideration when doing so.



Select the basic fabric softener dosage according to how soft you would like your laundry to be.

Changing one basic dosage affects all three dosage quantities in the same way.

Notes

- Reduce the basic dosage if using a very concentrated detergent.
- If large amounts of foam are repeatedly created during washing, please check your basic dosage and dosage quantity settings. Certain types of liquid detergent can also create excessive amounts of foam. If your basic dosage and dosage quantity settings are correct, we advise you to use a different detergent.

Changing the basic dosages:

1. Touch and hold the corresponding  **i-Dos** or  **i-Dos** button for approx. 3 seconds. The preset basic dosage will appear in the Touch-Display.
2. Set the required basic dosage using the →(**Finish in**) - or + buttons.
3. The setting is activated without needing to be confirmed. You can touch **i-Dos** buttons to revert to the original setting.

Note: The settings are saved until they are changed again, even if the appliance is switched off.

Manual dosage

For programmes that cannot be used with intelligent dosage, or if you would prefer to dose manually (in which case set intelligent dosage to "off"), add detergent to left-hand compartment.

Cleaning aids such as water softener, bleach and stain remover can be added to this compartment in addition to the intelligent dosage.

Warning **Eye/skin irritation!**

Detergent and care products may spray out if the detergent drawer is opened while the appliance is in operation. Open the drawer carefully. Rinse eyes or skin thoroughly if they come into contact with detergent/care products. If swallowed accidentally, seek medical advice.

Caution!**Damage to the appliance**

Cleaning agents and agents for pretreating laundry (e.g. stain removers, prewash sprays, etc.) may cause damage if they come into contact with the surfaces of the appliance. Do not allow these agents to come into contact with the surfaces of the appliance. If necessary, immediately wipe away spray residue and other residues/droplets with a damp cloth.

Notes

- When dosing all detergents, cleaning aids and cleaning agents, always follow the manufacturer's instructions.
- If dosing detergent manually, do not add additional detergent to the intelligent dosage dispenser (set intelligent dosage to "off"). This will prevent overdosing and foaming.
- Dilute viscous fabric softener and fabric conditioner with water to prevent blockages.

Dosing and adding detergent:

1. Pull out the detergent drawer.

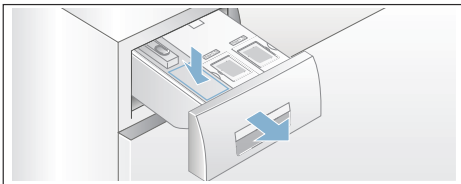

2. Add the correct dosage to left-hand compartment depending on:
 - Soiling
 - Water hardness (ask your water supply company)
 - The amount of laundry
 - The manufacturer's instructions
3. Close the detergent drawer.

**Appliance settings****Automatic switch-off**

If the appliance is not operated for a prolonged period (approx. 15 minutes), it may automatically switch off before the programme starts and when the programme has ended. Press the power button  again to switch on the appliance.

Basic settings

To access the basic settings, touch and hold the  **Silent wash** button for approx. 3 seconds. The control panel show:

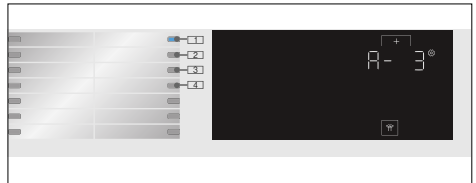

You can change the following basic settings:

- The volume of the end signal.
- The volume of the buttons.
- The brightness of the Touch-Display.
- Switching the drum care information signal on/off.

End signal

Touch and hold the  button for approx. 3 seconds. The indicator lamp in position **1** is on. You can use the **+** button to adjust the volume of the end signal, e.g. **A - 1**.

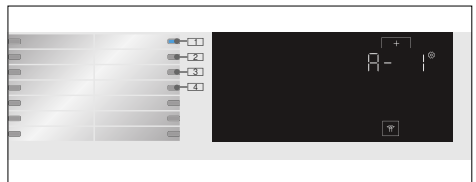

Possible setting values:

- 0 off
- 1 quiet
- 2 medium
- 3 loud
- 4 very loud

Button signal

You can touch position **2** and use the **+** button to adjust the volume of the button signal, e.g. **b - 3**.

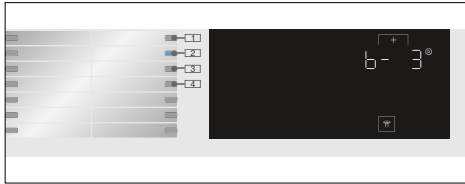

Possible setting values:

- 0 off
- 1 quiet
- 2 medium
- 3 loud
- 4 very loud

Brightness

Possible setting values: 1 - 4

You can touch position **3** and use the **+** button to adjust the brightness of the Touch-Display, e.g. **[- 3]**.

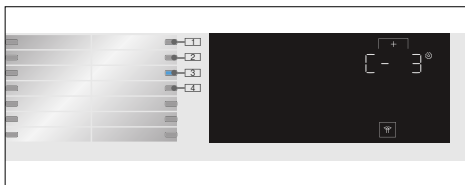

Possible setting values:

- 1 not very bright
- 2 normal level of brightness
- 3 bright
- 4 very bright

Switching the drum-care information signal on/off

You can touch position **4** and use the **+** button to switch the **Drum Clean** information signal on or off, e.g. **d - 1**.

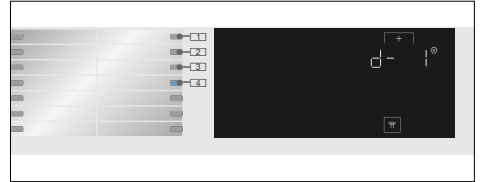

Possible setting values:

- 0 off
- 1 on



Sensors

Unbalanced load detection system

The automatic unbalanced load detection system detects imbalances and ensures even distribution of the laundry by repeatedly starting and stopping drum spinning.

If the laundry is extremely unevenly distributed, the spin speed is reduced or the spin cycle is not performed for safety reasons.

Note: Place large and small items of laundry evenly in the drum.

Aqua-Sensors

During the rinse cycle the Aqua sensor checks the degree of turbidity (turbidity is caused by dirt and detergent residue) of the rinsing water. The duration and the number of rinse cycles depend on the turbidity of the water.



Cleaning and maintenance

Warning

Risk of death!

There is a risk of electric shock if touch live components.
Switch off the appliance and pull out the mains plug.

Caution!

Fire and explosion hazard!

Toxic vapours can be produced by cleaning agents that contain solvents, e.g. cleaning solvent.
Do not use cleaning agents that contain solvents.

Caution!

The appliance may be damaged!

Cleaning agents that contain solvents, e.g. cleaning solvent, can damage surfaces and components in the appliance.
Do not use cleaning agents that contain solvents.

Appliance housing/control panel

- Remove the detergent residue immediately.
- Wipe the housing and the control panel with a soft, damp cloth.
- Do not use abrasive cloths, sponges or detergents (stainless steel cleaner).
- Do not clean the appliance with a water jet.

Drum

Use chlorine-free cleaning agents, do not use steel wool.

If there are odours in the appliance, or to clean the drum, run the  **Drum Clean 90 °C** programme without laundry.

Descaling

Descaling should not be necessary if the detergent is measured out correctly. However, if it is required, follow the manufacturer's instructions for the descaling agent. Suitable descalers can be obtained via our website or from customer services.

i-Dos detergent draw and its housing

1. Emptying the dispensers:

The dispensers have emptying outlets with removable sealing plugs at the front. To empty the dispensers, first remove the drawer handle as shown below:

- a) Pull out the detergent drawer.

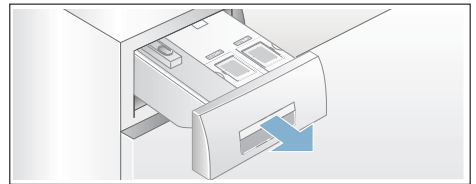

- b) Pull the catch (A) on the back of the drawer handle (in the centre at the bottom) slightly towards you. This unlocks the drawer handle (B), which you can then pull off by lifting it upwards.

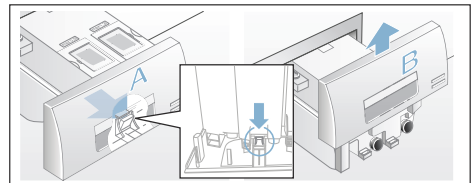

- c) To empty the dispensers, carefully pull off each of the sealing plugs and empty the contents into a suitable container.

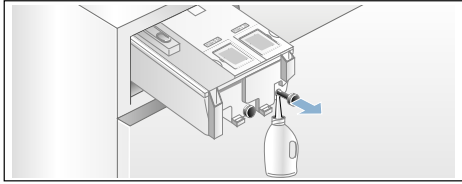

d) Then push the sealing plugs back in completely.

2. Cleaning the dispensers/detergent drawer:

The detergent drawer can be removed completely to allow you to clean the dispensers after you have emptied them.

a) Empty the dispensers before removing the drawer.

Note: Only put the drawer handle back on after you have finished cleaning.

b) Pull out the drawer.

c) Press the catch and remove the drawer completely.

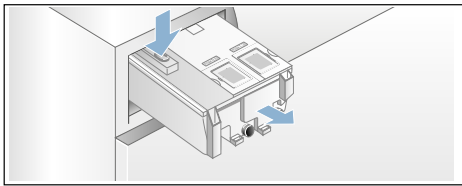

d) Carefully remove the drawer cover.

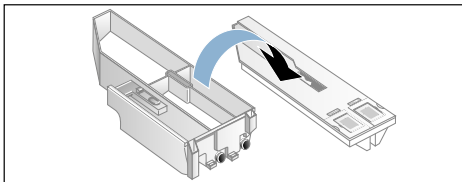

Caution!

Risk of damage to the detergent drawer.

The detergent drawer contains electrical components. These may become damaged if they come into contact with water.

- Do not clean the cover in the dishwasher and do not immerse it in water.

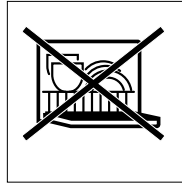

- Protect the rear drawer connector against water, detergent or fabric-softener residue; if necessary, clean the outer surfaces with a soft, damp cloth. Dry before putting back in.

e) Clean the drawer and the cover with a soft, damp cloth or a hand shower. Also clean the inner surfaces with a soft, damp cloth.

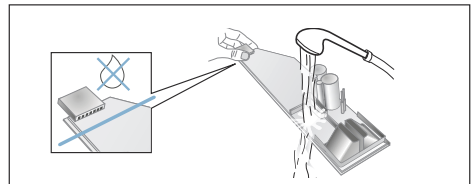

- f) Dry the drawer and the cover and put them back together.
- g) Push the drawer handle back in from above until you feel it click in place.
- h) Clean the inside of the detergent-drawer housing.
- i) Push the detergent drawer in completely.

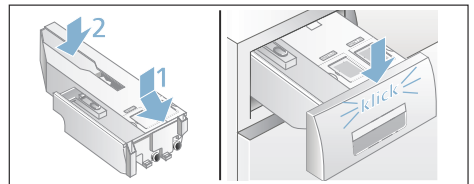

Drain pump is blocked

Note: Turn the tap off to prevent more water from flowing in and to ensure that it is drained via the pump.

⚠ Warning
Risk of scalding!

When you wash at high temperatures, the water gets very hot. If you come into contact with the hot water, you may be scalded.

Allow the water to cool down.

1. Switch off the appliance. Pull out the mains plug.
2. Open the service flap.

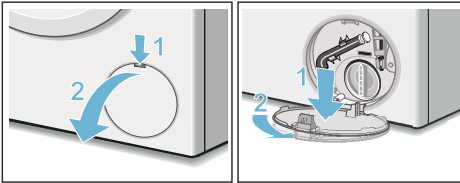

3. Take the drain hose out of the retainer.
 Remove the sealing cap and pour the water out into a suitable container.
 Replace the sealing cap and place the drain hose back in the retainer.

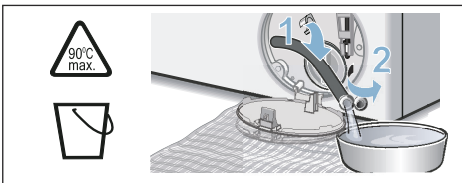

4. Carefully unscrew the pump cover; residual water may leak out.
 Clean the interior, pump cover thread and pump housing. The impeller in the drain pump must be able to rotate.
 Refit and screw on the pump cover. The handle must be in a vertical position.

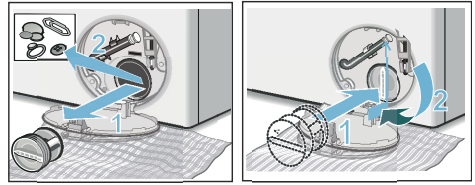

5. Close the service flap.

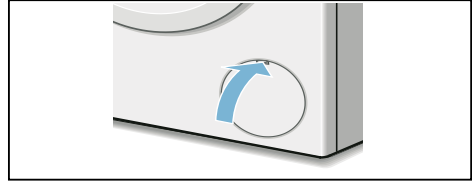

Note: To prevent unused detergent from flowing straight into the drain during the next wash: Pour 1 litre of water into left-hand compartment and start the **Rinse/Spin** programme.



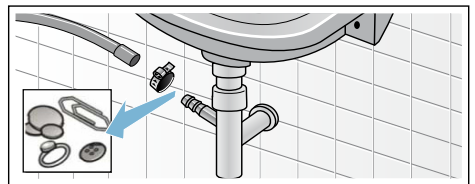

The drain hose at the siphon is blocked

1. Switch off the appliance. Pull out the mains plug.
2. Loosen the hose clamp. Carefully remove the drain hose; residual water may leak out.
3. Clean the drain hose and siphon connecting piece.



4. Re-attach the drain hose and secure the connection point using the hose clamp.

Filter in the water supply is blocked

1. Release water pressure in the supply hose:
 - a) Turn off the tap.
 - b) Select any programme (except  Rinse/Spin ).
 - c) Touch the  button. Allow the programme to run for approx. 40 seconds.
 - d) Press the  button. The appliance is switched off.
 - e) Pull out the mains plug.
2. Clean the filters:
 - a) Disconnect the hose from the tap.
Clean the filter with a small brush.

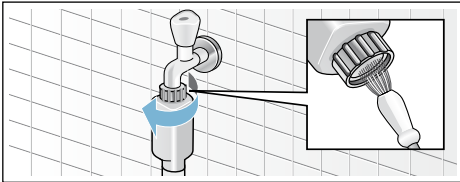

- b) For standard and Aqua-Secure models, clean the filter on the rear of the appliance:
Disconnect the appliance:
Disconnect the hose from the rear of the appliance.
Use pliers to remove the filter and then clean it.

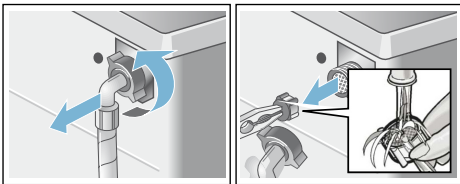

3. Connect the hose and check for leaks.

Faults and what to do about them

Emergency release

E.g. in the event of a power cut

The programme continues when the power supply is restored.

However, if the laundry has to be removed, the appliance door can be opened as follows:

Warning

Risk of scalding!

When you are washing at high temperatures, there is a risk of scalding if you come into contact with hot water and laundry.

If possible, leave it to cool down first.

Caution!

Risk when reaching into/gripping the rotating drum!

You may injure your hands if you reach into the drum while it is turning.

Do not reach into the drum when it is turning.

Caution!

Water damage!







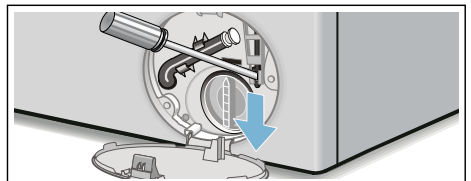



Any escaping water may cause water damage.

Do not open the door if water can be seen through the glass.

1. Switch off the appliance. Pull out the mains plug.
2. Drain the water.
3. Pull the emergency release downwards with a tool and release. The door can then be opened.





Information on the Touch-Display

Display	Cause/Remedy
	<ul style="list-style-type: none"> ■ Flashes fast + signal: The door was opened and the water level is too high. Close the door, continue the programme with  button or select  Rinse/Spin . ■ Flashes slowly: The door lock temperature is too high to open the door. Wait approx. 30 seconds until the door lock temperature cools down.
	<ul style="list-style-type: none"> ■ Flashes (no water supply): Tap turned on? Filter in the water supply is blocked? → "Filter in the water supply is blocked" on page 28 Is the supply hose kinked or trapped? ■ Lights up (low water pressure): For information only. This will not affect the programme progress. The programme duration is extended.
E:3610	<p>E:36 alternating display with -10 and End when programme is finished:</p> <ul style="list-style-type: none"> ■ The drain pump is blocked. → "Drain pump is blocked" on page 27 ■ The drain hose at the siphon is blocked. → "The drain hose at the siphon is blocked" on page 27
E:3510 (Suitable for special models)	<p>E:35 alternating display with -10 and End when programme is finished: there is water in the base trough, the appliance is leaking. Turn off the tap. Call customer services.</p>
E:602b	<p>E:60 alternating display with -2b and End when programme is finished: unbalance problem, spinning phase is aborted. Distribute small and large items of laundry evenly in the drum.</p>
 lights up	The childproof lock is activated – deactivate it.
 lights up	Too much foam has been detected and an additional rinse cycle has been activated. Reduce the basic dosage of  i-Dos for the next washing cycle with the same load.
The indicator lamp of the  Drum Clean programme flashes	<p>Run the  Drum Clean programme to clean and care for the drum and the outer tub.</p> <p>Notes</p> <ul style="list-style-type: none"> ■ Run the programme without laundry. ■ Use washing powder or a detergent containing bleach. To prevent foaming, only use half the amount of detergent recommended by the detergent manufacturer. Do not use detergent designed for woollens or delicates. ■ Switching the information signal on/off. → "Switching the drum-care information signal on/off" on page 24
Other displays	Switch off the appliance, wait for five seconds and then switch it on again. If the display appears again, call customer services.

Faults and what to do about them

Faults	Cause/Remedy
Water is leaking from the appliance.	<ul style="list-style-type: none"> ■ Attach the drain hose correctly or replace it. ■ Tighten the screw fitting on the supply hose.
The appliance is not filling with water.	<ul style="list-style-type: none"> ■ Programme does not start? ■ Is the tap turned on?
Detergent is not being dispensed.	<ul style="list-style-type: none"> ■ Could the filter in the water supply be blocked? → <i>"Filter in the water supply is blocked" on page 28</i> ■ Is the supply hose kinked or trapped?
The dispenser is empty and the fill level indicator is not flashing.	<ul style="list-style-type: none"> ■ Is the drawer cover/connector dirty? → <i>"i-Dos detergent draw and its housing" on page 25</i> ■ Has the detergent drawer been pushed in correctly?
The wrong detergent/fabric softener has been poured into the dispenser(s).	<p>Dispenser(s):</p> <ol style="list-style-type: none"> 1. Empty and clean. 2. Refill.
Detergent/fabric softener has congealed in the dispensers.	Clean and refill the dispensers.
The door cannot be opened.	<ul style="list-style-type: none"> ■ The safety function is activated. Stop the programme? ■ Can the door only be opened by the emergency release? → <i>"Emergency release" on page 28</i> ■ Childproof lock activated? Deactivate childproof lock. ■ The temperature in drum is too high to open the door. Wait approx. 30 seconds until the temperature in drum cools down. ■ The water level in drum is too high.
The programme will not start.	<ul style="list-style-type: none"> ■ Have you selected ▷ button or selected → (Finish in) time? ■ Is the door closed? ■  lights up: the detergent drawer has not been pushed in completely. Push the detergent drawer in correctly. ■ Childproof lock activated? Deactivate childproof lock.
The water is not draining.	<ul style="list-style-type: none"> ■ Could the drain pump be blocked? → <i>"Drain pump is blocked" on page 27</i> ■ Could the drain hose at the siphon be blocked? → <i>"The drain hose at the siphon is blocked" on page 27</i>
Water is not visible in the drum.	Not a fault – the water is below the visible area.
The spin result is not satisfactory. Laundry wet/too damp.	<ul style="list-style-type: none"> ■ Not a fault – the unbalanced load detection system has interrupted the spin cycle because the laundry is unevenly distributed. Distribute small and large items of laundry evenly in the drum. ■ Is Easy iron selected? (depending on the model) ■ Is Silent wash selected? ■ Is the selected speed too low?

Faults	Cause/Remedy
The spin cycle runs several times.	Not a fault – the unbalanced load detection system is adjusting an imbalance.
The programme is taking longer than usual.	<ul style="list-style-type: none"> ■ Not a fault – the unbalanced load detection system is adjusting an imbalance by repeatedly distributing the laundry. ■ Not a fault – the foam detection system is active – a rinse cycle has been switched on.
The length of the programme changes during the wash cycle.	Not a fault – the programme sequence is optimised for the specific washing process. This may change the length of the programme shown on the Touch-Display.
Residual water in the left-hand compartment for the care product.	Not a fault – the effectiveness of the care product is not affected.
Odours, stain formation in the appliance.	<p>Run the  Drum Clean 90 °C programme without laundry. Add washing powder or a detergent containing bleach.</p> <p>Note: To prevent foaming, only use half the amount of detergent recommended by the detergent manufacturer. Do not use detergents designed for woollens or delicates.</p>
Repeated, intensive foaming.	<ul style="list-style-type: none"> ■ Check your basic dosage and dosage strength settings. ■ If required, use a different liquid detergent.
Loud noises, vibrations and appliance "movement" during the spin cycle.	<ul style="list-style-type: none"> ■ Is the appliance aligned? → <i>"Alignment" on page 37</i> ■ Are the appliance's feet fixed? Secure the appliance's feet. ■ Have the transport locks been removed? → <i>"Removing the transport locks" on page 34</i>
The Touch-Display indicator lights do not work while the appliance is running.	<ul style="list-style-type: none"> ■ Has there been a power failure? ■ Have the fuses blown? Reset/replace the fuses. ■ If the fault occurs repeatedly, call customer services.
There is detergent residue on the laundry.	<ul style="list-style-type: none"> ■ Some phosphate-free detergents contain water-insoluble residue. ■ Select  Rinse/Spin  or brush the laundry after washing.
If you cannot rectify a fault yourself (after switching the appliance off and on again) or a repair is required: <ul style="list-style-type: none"> ■ Switch off the appliance and pull out the mains plug. ■ Turn off the tap and call customer services. 	



After-sales service

If you cannot rectify a fault yourself, (→ *"Faults and what to do about them" on page 30*), please contact our after-sales service.

We will always find an appropriate solution to avoid unnecessary visits by engineers.

Please provide the after-sales service with the product number (E-Nr.) and the production number (FD) of the appliance.

E-Nr. _____	FD _____
-------------	----------

E-Nr. Product number
FD Production number

You can find this information (depending on the model):

- On the inside of the loading door
- On the back of the appliance

Trust the expertise of the manufacturer. Contact us. By doing so, you can be sure that the repairs are carried out by trained service personnel using genuine spare parts.



Technical data

Dimensions:

84.5 x 59.8 x 62 cm
(height x width x depth)

Weight:

78 kg

Mains connection:

Nominal voltage 220–240 V, 50 Hz

Nominal current 10 A

Nominal power 1900-2300 W

Water pressure:

100–1000 kPa (1–10 bar)

Power consumption when switched off:

0,12 W

Power consumption when ready for use (left-on mode):

0,43 W



Positioning and connecting

Standard accessories

Note: Check the appliance for transport damage. Never use a damaged appliance. If you have any complaints, contact the dealer from whom you purchased the appliance or our Customer Service.

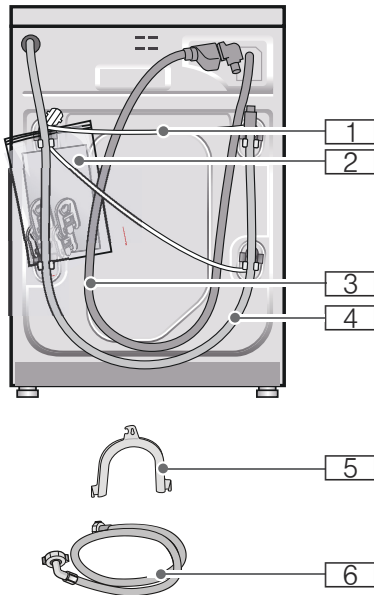

1 Mains lead

2 Bag:

- Installation and operating instructions
- Customer Service location directory*
- Warranty*
- Supplement*
- Cover caps for openings after the transport braces have been removed

3 Water inlet hose on aquaStop models

4 Water outlet hose

5 Elbow for securing the water outlet hose*

6 Cold water inlet hose on Standard/Aqua-Secure models

* Depending on the model

In addition, a hose clamp (24 - 40 mm diameter, available from specialist retailers) is required to connect the water outlet hose to a siphon.

Useful tool

- Spirit level for aligning
- Wrench with:
 - WAF13 for loosening the transport braces and
 - WAF17 for aligning the appliance feet

Safety instructions

Warning

Risk of injury!

- The appliance is very heavy. Be careful when lifting/transporting the appliance.
- When the appliance is lifted by its protruding parts (e.g. the appliance door), the components may break off and cause injuries. Do not lift the appliance by protruding parts.
- If the hose and mains cables are not routed properly, there is a risk of tripping and injury. Lay hoses and cables in such a way that there is no risk of tripping.

Caution!

Damage to the appliance

Frozen hoses may rip/burst. Do not install the appliance in areas exposed to frost or outdoors.

Caution!

Water damage

The connection points for the water supply hose and water drain hose are under high water pressure. To prevent leaks and water damage, you must follow the instructions in this section.

Notes

- In addition to the safety information listed here, the local water and electricity supplier may have special requirements.
- If in doubt, have the appliance connected by a specialist.

Installation surface

Note: The appliance must be stable aligned so that it does not move around.

- The installation surface must be firm and level.
- Soft floors/floor coverings are not suitable.

Installation on a base or a wooden joist floor

Caution!

Damage to the appliance

The appliance may "wander" and tip/topple from the base when spinning. The feet of the appliance must be secured with holding brackets. Order no. WMZ 2200, WX 9756, CZ 110600, Z 7080X0.

Note: On wooden joist floors, install the appliance:

- In a corner, if possible,
- On a water-resistant wooden board (min. 30 mm thick) which is screwed tightly to the floor.

Installation on a platform with drawer

Platform order no.: WMZ 20490, WZ 20490, WZ 20510, WZ 20520

Installing the appliance in a kitchenette

Warning Risk of death!

There is a risk of electric shock if you touch live components. Do not remove the appliance covering plate.

Notes

- Recess width of 60 cm required.
- Only install the appliance underneath a continuous worktop that is securely connected to adjacent cabinets.

Removing the transport locks

Caution!

Damage to the appliance

- The appliance is secured for transportation using transport locks. If the transport locks are not removed, the appliance may become damaged when it is operated. Before using the appliance for the first time, make sure that you completely remove all four transport locks. Keep the locks in a safe place.
- To prevent transport damage from occurring if the appliance is moved at a later date, you must refit the transport locks before transporting the appliance.

Note: Keep the screws and sleeves in a safe place.

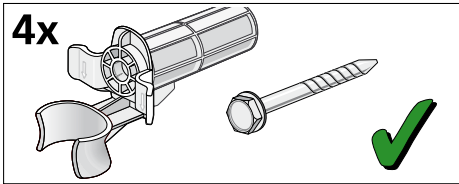

1. Take the hoses out of the holders.

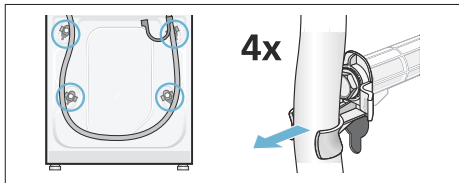

2. Unscrew and remove all four transport brace screws. Remove the sleeves. To do this, remove the mains cable from the holders.

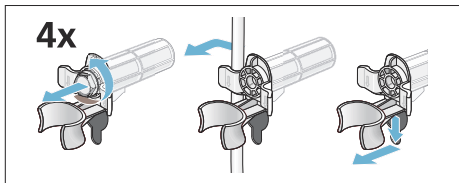

3. Fit the covers. Lock the covers firmly in place by applying pressure to the snap-in hooks.

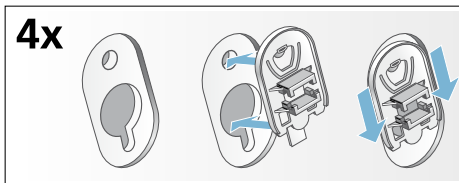

Hose and cable lengths

■ Left-hand connection

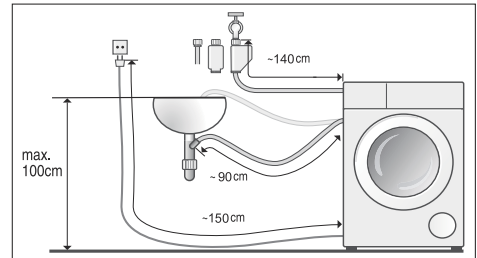

■ Right-hand connection

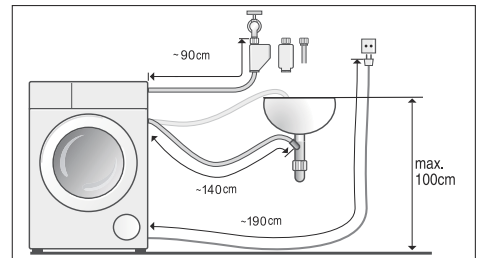

Tip: The following are available from specialist dealers/the after-sales service:

- An extension for Aqua-Stop or cold water supply hose (approx. 2.50 m); order no. WMZ2380, WZ10130, CZ11350, Z7070X0
- A longer supply hose (approx. 2.20 m) for standard model

Water inlet

⚠ Warning **Risk of death!**

There is a risk of electric shock if you touch live components.

Do not immerse the Aqua-Stop safety valve* in water (it contains an electric valve).

* Depending on the model

Observe the following when connecting the appliance:

Notes

- Only operate the appliance using cold mains water.
- Do not connect the appliance to the mixer tap of an unpressurised hot-water boiler.
- Do not use a used supply hose. Only use the supply hose supplied or one that was purchased from an authorised specialist retailer.
- Do not bend, squash, modify or cut through the water supply hose (otherwise its strength is no longer guaranteed).
- Only tighten the screw connections by hand. If the screw connections are tightened too much with a tool (pliers), the thread may be damaged.

Optimum water pressure in the supply network

At least 100 kPa (1 bar)

Maximum 1000 kPa (10 bar)

When the tap is open, the water flow is at least 8 l/min.

If the water pressure is higher than this, a pressure-reducing valve must be installed.

Connection

1. Connect the water supply hose to the water tap ($\frac{3}{4}$ " = 26.4 mm) and to the appliance:
 - Model: **Standard**

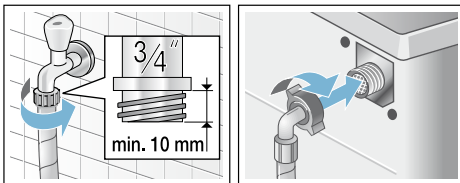

- Model: **Aqua-Secure**

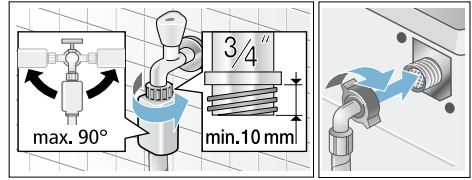

- Model: **Aqua-Stop**

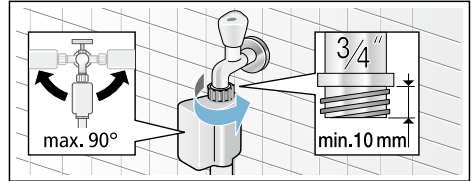

2. Open the water tap carefully, checking the leak tightness of the connection points. The screw connection is under mains water pressure.

Water outlet

Warning **Risk of scalding!**

When you are washing at high temperatures, there is a risk of scalding if you come into contact with hot water (e.g. when draining hot water into a washbasin).
Do not reach into the hot water.

Caution! **Water damage**

If the drain hose slips out of the washbasin or the connection point during draining due to high water pressure, any escaping water may cause water damage.
Secure the drain hose so that it cannot slip out.

Caution!**Damage to the appliance/fabrics**

If the end of the drain hose is immersed in the drained water, water may be sucked back into the appliance and may damage the appliance/fabrics.

Make sure that:

- The plug does not block drainage from the washbasin.
- The end of the drain hose is not immersed in the drained water.
- The water drains away quickly enough.

Note: Do not kink the water drain hose or put strain on it lengthways.

Connection

- **Drainage into a washbasin**

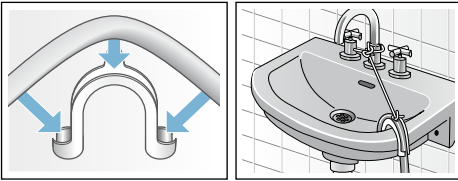

- **Drainage into a siphon**

The connection point must be secured using a hose clamp with a diameter of 24 - 40 mm (available from specialist dealers).

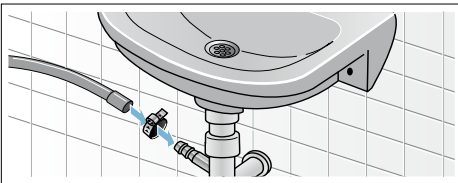

- **Drainage into a plastic pipe with rubber bushing or into a drainage pit**

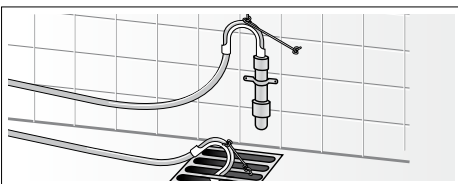
**Alignment**

Level the appliance using a spirit level.

Incorrect levelling may result in intense noise, vibrations and "wandering".

1. Loosen the lock nuts using a wrench, by turning it in a clockwise direction.
2. Check the alignment of the appliance with a spirit level, and adjust it if necessary. Change the height by turning the appliance feet. All four appliance feet must stand firmly on the ground.

3. Tighten the lock nut against the housing.

In doing so, hold the foot tight and do not adjust its height.

The lock nuts on all four appliance feet must be screwed tightly against the housing.

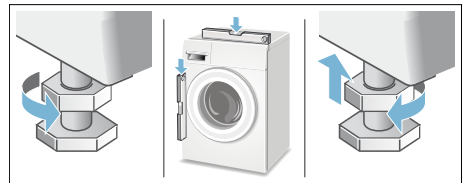

Electrical connection

Warning **Risk of death!**

There is a risk of electric shock if you touch live components.

- Never touch or hold the mains plug with wet hands.
- Only pull out the mains cable by the plug and never by the cable, as this could damage it.
- Never unplug the mains plug during operation.

Observe the following information and ensure that:

Notes

- The mains voltage and voltage indicated on the appliance (rating plate) are the same.
The connected load and fuse required are specified on the rating plate.
- The appliance is only connected to an alternating current via a properly installed earthed socket.
- The mains plug fits the socket.
- The cable cross-section is adequate.
- The earthing system is properly installed.
- The mains cable is only replaced by a qualified electrician (if this is necessary). Replacement mains cables are available from the after-sales service.
- No multiple plugs/couplings or extension cables are used.
- If an earth-leakage circuit breaker is used, only a type which displays this symbol is used: .
Only this symbol guarantees compliance with the currently applicable regulations.
- The mains plug can be accessed at all times.
- The mains cable is not bent, squashed, modified, cut through, or in contact with heat sources.



Before washing for the first time

The appliance was thoroughly tested before leaving the factory. To remove any water that may be left over from the test, run the first wash cycle **without** any laundry.

Notes

- The appliance **must be correctly installed** and **connected**.
- Never use a damaged appliance. Inform customer services.

Preparatory work:

1. Check the appliance.
2. Fill the dispenser  and .
3. Plug into the mains.
4. Turn on the tap.

Run the programme without laundry.

1. Switch on the appliance.
2. Close the door (do not load any laundry).
3. Set the  **Drum Clean 90 °C** programme.
4. Open the detergent drawer.
5. Pour approx. 1 litre of water into the left-hand compartment.
6. Pour standard detergent into the left-hand compartment.
Note: To prevent foaming, only use half of the amount of detergent recommended by the detergent manufacturer. Do not use detergents designed for woollens or delicates.
7. Close the detergent drawer.
8. Start the programme.
9. Switch off the appliance at the end of the programme.

Your appliance is now ready to use.

Transportation

e.g. when moving home

Preparatory work:

1. Turn off the water tap.
2. Reduce the water pressure in the supply hose.
→ "Filter in the water supply is blocked" on page 28
3. Drain any residual water.
→ "Drain pump is blocked" on page 27
4. Disconnect the appliance from the mains.
5. Remove the hoses.
6. Empty the dispensers.
→ "i-Dos detergent draw and its housing" on page 25

Installing the transport locks:

1. Remove the covers and keep them in a safe place.
Use a screwdriver if necessary.

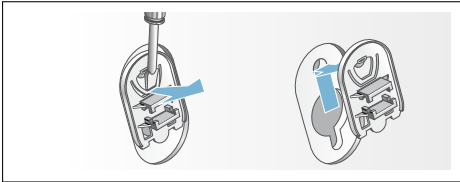

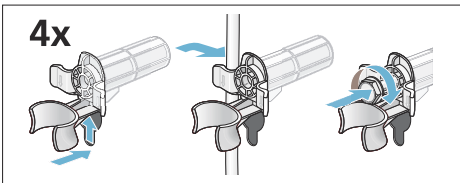

2. Insert all four sleeves.
Clip the mains cable securely in the holders. Insert and tighten the screws.



Before switching on the appliance again:

Notes

- The transport braces **must** be removed.

- Pour approx. 1 litre of water into left-hand compartment, select the  **Rinse/Spin**  programme or and start.
This will prevent detergent from flowing straight into the drain during the next wash.

Aqua-Stop

Aqua-Stop warranty

Only for appliances with Aqua-Stop

In addition to warranty claims against the vendor based on the purchase agreement and to our appliance warranty, we will provide compensation under the following conditions:

1. If water damage is caused due to a fault in our Aqua-Stop system, we will compensate domestic customers for the damage caused.
2. The liability guarantee is valid for the service life of the appliance.
3. It is a prerequisite of all warranty claims that the appliance with Aqua-Stop must have been installed and connected correctly in accordance with our instructions; this also includes a correctly fitted Aqua-Stop extension (genuine accessories). Our warranty does not cover defective feed lines or fittings leading to the Aqua-Stop connection at the tap.
4. Appliances with Aqua-Stop do not need to be supervised during operation, nor secured afterwards by turning off the tap.
The tap only needs to be turned off if you are away from home for a long period, e.g. for several weeks' holiday.

Repair order and advice in the event of faults

GB 0344 892 8999 (Calls charged at local or mobile rate.)

IE 01450 2655 (0.03 € per minute at peak. Off peak 0.0088 € per minute.)

You can find the contact information for all countries in the attached after-sales service directory.

BSH Hausgeräte GmbH

Carl-Wery-Straße 34

81739 München

GERMANY

siemens-home.bsh-group.com

Manufactured by BSH Hausgeräte GmbH under Trademark License of Siemens AG



9001075507 (9611)