



SIEMENS



# Washing machine

WM..T...

[siemens-home.com/welcome](https://siemens-home.com/welcome)

en Instruction Manual and Installation Instructions

Register  
your  
product  
online

## Your new washing machine

You have chosen a Siemens washing machine.

Please take a few minutes to read and become familiar with the advantages of your washing machine.

To meet the high quality demands required by Siemens, every washing machine that leaves our factory is carefully checked to ensure that it functions correctly and is in perfect condition.

For more information on our products, accessories, replacement parts and services, see our website [www.siemens-home.com](http://www.siemens-home.com) or contact our after-sales service centres.

If the operating and installation instructions describe different models, any differences will be pointed out at the relevant points in the text.



Read these operating and installation instructions before switching on the washing machine.

## Display rules

### **Warning!**

This combination of symbol and signal word indicates a possibly dangerous situation. Not heeding the warning can cause death or injuries.

### **Caution!**

This signal word indicates a possibly dangerous situation. Not heeding the caution can cause property and/or environmental damage.

### **Note/tip**

Information about the optimum use of the appliance/any other useful information.













### **1. 2. 3. / a) b) c)**

The steps are represented by numbers or letters.

■ / -

Lists are represented by a small box or a dash.

# Contents

	<b>Intended use</b> . . . . .	4		<b>Operating the appliance</b> . . . . .	16
	<b>Safety instructions</b> . . . . .	5		Preparing the washing machine . . . . .	16
	Electrical safety . . . . .	5		Select programme/switch on the appliance . . . . .	16
	Risk of injury . . . . .	5		Change the programme default settings . . . . .	16
	Safety for children . . . . .	5		Select additional programme settings . . . . .	16
	<b>Environmental protection</b> . . . . .	7		Placing laundry into the drum . . . . .	17
	Packaging/used appliance . . . . .	7		Measure and add detergent and care products . . . . .	17
	Tips on economical use . . . . .	7		Starting the programme . . . . .	18
	<b>Getting to know the appliance</b> . . . . .	8		Childlock . . . . .	18
	Washing machine . . . . .	8		Adding/removing laundry . . . . .	19
	Control panel . . . . .	9		Changing the programme . . . . .	19
	Display panel . . . . .	9		Cancel the programme . . . . .	19
	<b>Laundry</b> . . . . .	11		Programme end during rinse hold . . . . .	20
	Prepare the laundry . . . . .	11		Programme end . . . . .	20
	Sorting laundry . . . . .	11		Removing laundry/switching off the appliance . . . . .	20
	Starching . . . . .	11		<b>Sensors</b> . . . . .	21
	Dyeing/bleaching . . . . .	12		Automatic load sensing . . . . .	21
	Soaking . . . . .	12		Unbalanced load detection system . . . . .	21
	<b>Detergent</b> . . . . .	12		VoltMonitor . . . . .	21
	Correct selection of detergent . . . . .	12		<b>Setting the signal</b> . . . . .	22
	Saving energy and detergent . . . . .	13		<b>Cleaning and maintenance</b> . . . . .	23
	<b>Programme default settings</b> . . . . .	13		Machine housing/control panel . . . . .	23
	Temperature . . . . .	13		Drum . . . . .	23
	Spin speed . . . . .	13		Descaling . . . . .	23
	Finished in-time . . . . .	14		Detergent drawer and housing . . . . .	23
	<b>Additional programme settings</b> . . . . .	15		Detergent solution pump blocked . . . . .	24
	speed eco . . . . .	15		The drain hose at the siphon is blocked . . . . .	25
	Less iron . . . . .	15		Filter in the water supply is blocked . . . . .	25
	Prewash . . . . .	15			
	Water Plus . . . . .	15			
	Rinse Plus . . . . .	15			

	<b>Faults and what to do about them</b> .....	26
	Emergency release .....	26
	Information on the display panel . . .	27
	Faults and what to do about them. .	28
	<b>After-sales service</b> .....	31
	<b>Technical data</b> .....	31
	<b>Positioning and connecting</b> . . .	32
	Included with the appliance .....	32
	Safety instructions .....	33
	Installation surface .....	33
	Installation on a base or a wooden joist floor .....	33
	Installation on a platform with drawer .....	33
	Installing the appliance in a kitchenette .....	34
	Removing the transport locks . . . . .	34
	Hose and cable lengths .....	35
	Water inlet .....	35
	Water outlet .....	36
	Levelling .....	37
	Electrical connection .....	37
	Before washing for the first time . . .	38
	Transportation .....	39

---

## Intended use

- For private domestic use only.
- The washing machine is suitable for washing machine-washable fabrics and hand-washable wool in detergent solution.
- To be operated with cold mains water and standard detergents and care products which are suitable for use in front-loading washing machines. Do not use detergents for hand wash.
- When measuring the amount of all detergents/additives/care products and cleaning agents, always check the manufacturer's instructions.
- The washing machine may be used by children over the age of 8 years old and by persons with reduced physical, sensory or mental capacity or by persons with a lack of experience or knowledge if they **are supervised** or have **been instructed** by a responsible person. Children must not perform cleaning or maintenance work unsupervised.
- Keep children under the age of 3 years away from the washing machine.
- This appliance is intended for use up to a maximum height of 4000 metres above sea level.
- Keep pets away from the washing machine.

Read the Instruction Manual and Installation Instructions and all other information supplied with the washing machine and use the machine accordingly.

Retain the documents for subsequent use.

## Safety instructions

### Electrical safety

#### Warning

##### **Risk of death!**

There is a risk of electric shock if you touch live components.

- Never touch or hold the mains plug with wet hands.
- Only pull out the mains cable by the plug and never by the cable, as this could damage it.
- The appliance must be grounded.  
Electrical connection

### Risk of injury

#### Warning

##### **Risk of injury!**

- When the washing machine is lifted by its protruding parts (e.g. the washing machine door), the components may break off and cause injuries.  
Do not lift the washing machine by protruding parts.
- If you climb on the washing machine, the worktop may break and cause injuries.  
Do not climb onto the washing machine.

- If you lean on the washing machine door when it is open, the washing machine may tip over and cause injuries.  
Do not lean on the washing machine door when it is open.
- Reaching into the drum when it is turning can cause injuries to hands.  
Do not reach into the drum when it is turning.  
Wait until the drum has stopped turning.

#### Warning

##### **Risk of scalding!**

When you are washing at high temperatures, there is a risk of scalding if you come into contact with hot water e.g. if hot water is being drained into a wash basin.  
Do not reach into the hot detergent solution.

### Safety for children

#### Warning

##### **Danger of death!**

- If children play with the washing machine, they may get into life-threatening situations or injure themselves.
- Do not leave children unattended near the washing machine.
  - Do not let children play with the washing machine.

 **Warning**

**Danger of death!**

Children may lock themselves in appliances, putting their lives at risk.

For appliances that have reached the end of their service life:

- Disconnect the mains plug.
- Cut through the mains cable and remove it, along with plug.
- Destroy the lock on the washing machine door.

 **Warning**

**Risk of suffocation!**

Children may become wrapped in packaging/film or packing parts if allowed to play with them, or they may pull them over their heads and suffocate. Keep packaging, film and packaging parts out of the reach of children.

 **Warning**

**Risk of poisoning!**

Detergents and care products may be poisonous if consumed.

Keep detergents and care products out of the reach of children.

 **Warning**

**Eye/skin irritation!**

Detergents and care products may cause irritation if they come into contact with the eyes or skin.

Keep detergents and care products out of the reach of children.

 **Warning**

**Risk of injury!**

When you wash at high temperatures, the glass in the washing machine door gets hot.

Do not let children touch the hot washing machine door.



## Environmental protection

### Packaging/used appliance



Dispose of packaging in an environmentally-responsible manner.

The following Do's and Don'ts provide a framework for the return and recycling of used products when available in your area.

#### Do's

- Hand over the old/discarded electronic equipment only to authorized collection centers for disposal
- Consult the authorized service center as to whether the Electronic Equipment can be repaired or not, before discarding
- Consult the retailer about appliance take back schemes

#### Don'ts

- Don't dump the discarded Electronic Equipment in the open or in any land fill site, as this will result in contamination of the soil and the ground water
- Don't dispose of the discarded Electronic Equipment in household bins or Municipal bins
- The product is not meant for re-sale to any unauthorized agencies/scrap dealers
- Don't keep any replaced spare part(s) from the product in an exposed area

### Tips on economical use

- Fill the appliance with the maximum amount of laundry for each programme to save energy and water to an optimum.  
Overview of programmes  
→ Supplementary sheet for the operating and installation instructions.
  - Wash normally soiled laundry without a prewash.
  - Save energy and detergent when washing lightly and normally soiled laundry.  
→ *"Detergent" on page 12*
  - The selectable temperatures apply to the care labels on the textiles. The temperatures in the machine may deviate from this so that you get the optimum mix of energy-saving and washing results.
  - **Information about the energy consumption\*:**  
The display provides information about the relative energy consumption in the selected program.  
The more indicator lights light up, the higher the program's consumption.  
This enables you to compare the consumption levels of the different programs when choosing your program settings and to decide on an energy- and water-saving program setting for the selected program.
  - **Energy-saving mode:** The display panel lighting goes out after a few minutes and the start button flashes. To activate the lighting, press any button.  
Energy-saving mode is not activated if a programme is running.
  - If the laundry is subsequently dried in a tumble dryer, select the spin speed according to the tumble dryer manufacturer's instructions.
- \* depending on the model

## Getting to know the appliance

### Washing machine

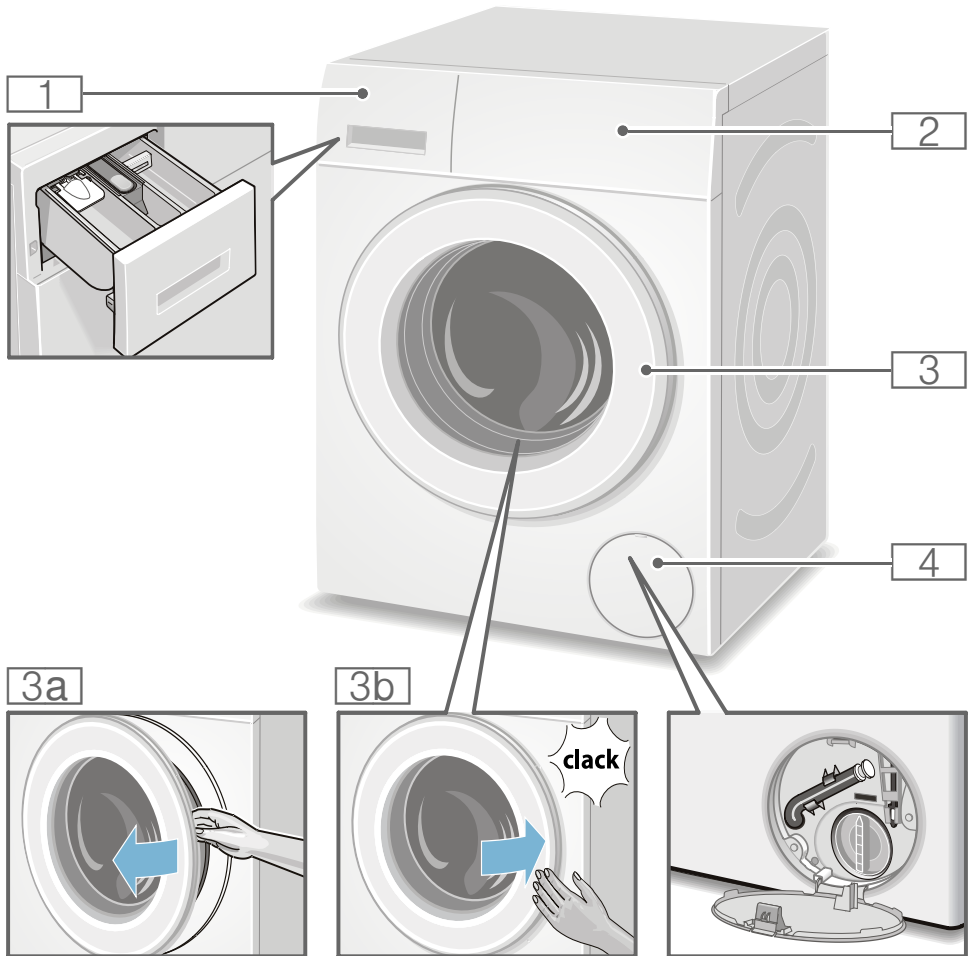

- 1** Detergent drawer
- 2** Controls/display elements
- 3** Washing machine door with integrated window handle
- 3a** Open the washing machine door
- 3b** Close the door
- 4** Service flap



## Control panel

Control panel depending on the model



- 1** Programmes → Supplementary sheet for the operating and installation instructions.
- 2** Programme selector

- 3** Display panel for settings and information

**Note:** The buttons are sensitive, they only need to be touched gently.

## Display panel

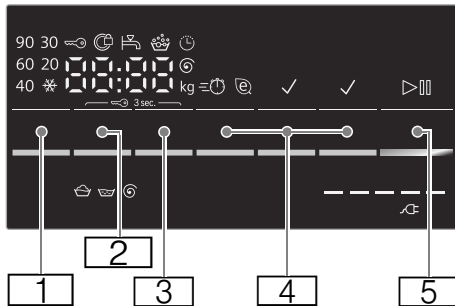

Button	Display indicator	Description
<b>1</b>		selectable <b>Temperature</b> **
	❄ -90 °C	in °C; ❄ = cold
<b>2</b>		selectable <b>Spin speed</b>
	----, 0 - 1200** ⌚	in rpm; 0 = no spin cycle, draining only; ---- = Rinse Stop
<b>3</b>		<b>Finished in-time</b>
* depending on the model		
** depending on the selected program, settings and model		

## en Getting to know the appliance

Button	Display indicator	Description
	e.g. 2:30	Program duration depends on the program selection in h:min (hours:minutes)
	1 - 24 🕒	End time preselection in hours
		End of program after ... hours
<b>4</b>		<b>Additional program settings:</b> → <i>Page 15</i>
	(≡🕒)**	speed ecoPerfect
	(👤)**	Less iron*
	(⏴)**	Prewash*
	(👉, 👉 Water+)	Water Plus*
	(👉, Rinse+)	Rinse Plus*
<b>5</b>	▶🔊	<b>Button</b> for starting a program, Interrupting a program, e.g. to add items of laundry or cancelling a program

\* depending on the model  
 \*\* depending on the selected program, settings and model

### More information on the display panel

Display indicator	Description
8** kg	<b>Load recommendation</b>
🔌 = ...	<b>Energy consumption*</b>
	<b>Program progress:</b>
👤	Washing
👉	Rinse
🌀	Spin
End	Program end
----🌀	Program end during Rinse Stop
🔒	<b>Washing machine door</b>
👉	<b>Tap</b>
	→ "Information on the display panel" on page 27

\* depending on the model  
 \*\* depending on the selected program, settings and model

Display indicator	Description
🔒	<b>Childproof lock</b> → "Childlock" on page 18
👤	<b>Foam detection</b>
E: --	<b>Fault display</b>
0 - 4	<b>Signal setting</b>

\* depending on the model  
 \*\* depending on the selected program, settings and model

## Laundry

### Prepare the laundry

#### Caution!

#### Damage to the appliance/fabrics

Foreign objects (e.g. coins, paper-clips, needles, nails) may damage the laundry or components in the washing machine.

Therefore, note the following tips when preparing your laundry:

- Empty pockets.

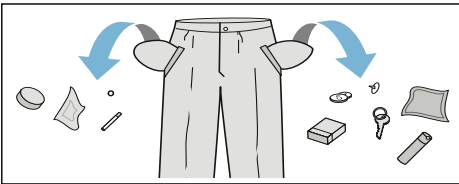





- Look out for metal items (paperclips, etc.) and remove them.
- Wash delicates in a laundry bag (tights, underwired bras, etc.).
- Close any zips, button up any cover buttons.
- Brush sand out of pockets and collars.
- Remove curtain fittings or place curtains in a laundry bag.

### Sorting laundry

Sort your laundry according to the care instructions and manufacturer's information on the care labels:

- Type of fabric/fibre
- Colour
  - Note:** Laundry can discolour or not be cleaned correctly. Wash white and coloured laundry separately. Wash new bright fabrics separately the first time you wash them.
- Soiling
  - Wash laundry with the same level of soiling together.

You can find examples of levels of soiling on → *Page 13*

- **Light:** Do not prewash, select the (speed Perfect)  $\equiv$  setting if necessary
- **Normal**
- **Heavy:** Load less laundry, select a programme with prewash
- **Stains:** Remove/pretreat stains while they are fresh. First, dab the stain with soapy water/do not rub. Then wash the items of laundry with the appropriate programme. Stubborn/dried-in stains can sometimes only be removed with several washes.
- Symbols on the care labels
  - The numbers in the symbols indicate the maximum washing temperature which may be used.
  -  : Suitable for a normal washing process; e.g. **Cottons** programme
  -  : A gentle washing process is required; e.g. **Easy-Care** programme
  -  : An especially gentle washing process is required; e.g. **Delicate/Silk** programme
  -  : Suitable for washing by hand; e.g. **Wool** programme
  -  : Do not wash the laundry in the machine.

### Starching

**Note:** Laundry must not be treated with fabric softener.



Starching is possible in all wash programmes if liquid starch is used. Starching with liquid starch is possible in programs such as Rinse and Cottons

## Dyeing/bleaching

Dye should only be used in normal household quantities. Salt may damage stainless steel. Always follow the dye manufacturer's instructions.

Do **not** use the washing machine to bleach clothes.

## Soaking

1. Pour soaking agent/detergent into compartment **II** in accordance with the manufacturer's instructions.
2. Select the desired programme.
3. Press the  button to start the programme.
4. After approx. ten minutes, press the  button to pause the programme.
5. After the desired soaking time, press the  button again to continue or change the programme.

### Notes

- Load laundry of the same colour.
- No additional detergent is required; the soaking solution is used for washing.

---

## Detergent

### Correct selection of detergent

The care label is crucial for selecting the correct detergent, temperature and treatment of the laundry.

**Note:** Only use detergents for front-loading washing machines, low suds/detergent foam.

- **Standard detergent with optical brighteners**  
Suitable for boil-washable white laundry made from linen or cotton  
Programme: Cottons/  
cold - max. 90 °C
- **Detergent for colours without bleach or optical brighteners**  
Suitable for coloured laundry made from linen or cotton  
Programme: Cottons/  
cold - max. 60 °C
- **Detergent for colours/delicates without optical brighteners**  
Suitable for coloured laundry made from easy-care fibres, synthetic fibres  
Programme: Easy-Care/  
cold - max. 60 °C
- **Detergent for delicates**  
Suitable for delicate, fine fabrics, silk or viscose  
Programme: Delicate/Silk/  
cold - max. 40 °C
- **Detergent for woollens**  
Suitable for wool  
Programme: Wool/  
cold - max. 40 °C

## Saving energy and detergent

For light and normal soiling, you can save energy (lower washing temperature) and detergent.

Saving	Soiling/note
<p>Reduced temperature and detergent quantity as per the recommended dosage</p>  <p>Temperature as per the care label and detergent quantity as per the recommended dosage for heavy soiling</p>	<p><b>Light</b> No visible dirt or stains. Clothing has taken on some body odour, e.g.:</p> <ul style="list-style-type: none"> <li>■ Light summer/sports clothing (worn for a few hours)</li> <li>■ T-shirts, shirts, blouses (worn for up to one day)</li> <li>■ Guest bed linen and hand towels (used for one day)</li> </ul>
	<p><b>Normal</b> Visible dirt or a few light stains, e.g.:</p> <ul style="list-style-type: none"> <li>■ T-shirts, shirts, blouses (sweat soaked, worn a few times)</li> <li>■ Towels, bedding (used for up to one week)</li> </ul>
	<p><b>Heavy</b> Dirt and/or stains clearly visible, e.g. tea towels, baby items, work clothing</p>

**Note:** When measuring the amount of all detergents/additives/care products and cleaning agents, please always check the manufacturer's instructions and information.  
→ "Measure and add detergent and care products" on page 17

## P+ Programme default settings

The temperature, spin speed and programme duration ("Ready in" time) for all programmes are preset at the factory.

These are displayed in the display panel after selecting the programme.

You can change the default settings.  
→ Page 16

You can find an overview of all possible program settings on the supplementary sheet for the installation and operating instructions.

### Temperature

(°C, °C Temp.)

Setting depending on the model

Depending on what stage the program is in, you can change the set temperature before and at the beginning of the program.

The maximum temperature that can be set depends on the program that has been selected.

### Spin speed

(@, @ rpm)

Depending on what stage the program is in, you can change the spin speed (in rpm; revolutions per minute) before and during the program.

**Setting 0:** The rinsing water is drained but there is no final spin. The laundry stays wet inside the drum, e.g. for items that should not be spun.

**Setting - - - :** (Rinse Stop) = no final spin. The laundry stays in the water after the final rinse.

## en Programme default settings

You can select "Rinse Stop" to prevent creasing if the laundry will not be taken out of the washing machine immediately after the program has ended.

To continue/end the program  
→ Page 20

The maximum speed that can be set depends on the model and program that has been selected.

### Finished in-time

(🕒, 🕒 Finish in, 🕒 Ready in)

**Before starting the program**, you can preselect the program end ("Ready in" time) in hourly increments (h = hour) up to a maximum of 24 hours.

To do this:

1. Select a program.  
The program duration is displayed for the selected program, e.g. **2:30** (hours:minutes).
2. Press the **Finished in-time** button repeatedly until the required number of hours is displayed.
3. Press the ▷ button.  
The door will be locked.  
The selected number of hours (e.g. **8 h**) is shown in the display panel and counts down until the wash program starts. The duration of the program is then displayed.

**During the timer count-down**, you can change the preselected number of hours as follows:

1. Press the ▷ button.
2. Use the **Finished in-time** button to change the number of hours.
3. Press the ▷ button.

**During the timer count-down**, you can add or remove laundry as required:

1. Press the ▷ button.
2. Open the door and add or remove laundry.
3. Close the door.
4. Press the ▷ button.

**Note:** The length of the program is automatically adjusted when the program is running.  
Certain factors can affect the program length, e.g.:

- Program settings,
- Detergent dosage (additional rinse cycles if required due to foaming),
- Load size/type of textiles (longer washing for higher load and for textiles which absorb more water),
- Imbalances (e. g. due to fitted sheets) are offset with several start-ups of spin cycles,
- Fluctuations in power supply,
- Water pressure (infeeding speed).

## **P+** Additional programme settings



You can find an overview of all possible additional settings on the supplementary sheet for the installation and operating instructions.

The settings vary depending on the model.

### speed eco

(,  speedPerfect,  ecoPerfect)

Button with two possible settings for adapting the selected program:

- **speed** ()  
Washing in a shorter time while achieving a washing result that is consistent with, but uses more energy than the selected program without the speed setting.  
**Note:** Do not exceed the maximum load.
- **eco** ()  
Energy-optimised washing by reducing the temperature while achieving a washing result that is consistent with the selected program without the eco setting.

Press the button to do this. First of all, you can select the **speed** setting. If you press the button again, the **eco** setting is active. The respective symbol is shown in the display when the setting is activated.

If you press the button again, no setting is active.

### Less iron

() Less iron)

Button depending on the model

Reduces creasing thanks to a special spin sequence followed by fluffing and reduced spin speed.

**Note:** The washing's residual moisture is increased.

### Prewash

() Prewash)

Button depending on the model

For heavily soiled laundry.

There will be a prewash cycle at a low temperature before the main washing.

**Note:** Pour detergent into compartment **I** for the prewash cycle and into compartment **II** for the main washing.

### Water Plus

(,  Water+)

Button depending on the model

Higher water level and additional rinse cycle for particularly sensitive skin and/or for areas with very soft water

### Rinse Plus

(, Rinse+)

Button depending on the model

Additional rinse cycle, for areas with very soft water or for an even better rinsing result.



## Operating the appliance

### Preparing the washing machine

**Note:** The washing machine **must be correctly installed** and **connected**.

Also consider

1. Connect the mains plug.
2. Turn on the water tap.
3. Open the door.
4. Check that the drum is completely drained. Drain if necessary.

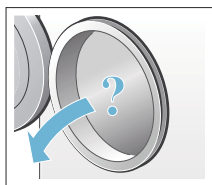
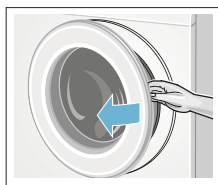

### Select programme/switch on the appliance

**Note:** If you have activated the childproof lock, you must first deactivate it before you can set a program.

→ Page 18

Use the program selector to select the required program. The program selector can be rotated in either direction.

The appliance is switched on.

The following **default settings** and program information for the selected program appear in the display panel

- Temperature\*,
- The maximum recommended load and the duration of the program (alternately)
- Energy consumption\*.

\*depending on the model

### Change the programme default settings

You can use the default settings or change them.

To do this, repeatedly select the corresponding button until the required setting is displayed.

The settings are activated without needing to be confirmed.

They are not saved when the appliance is switched off.

→ "Programme default settings" on page 13

Overview of programmes → Supplementary sheet for the operating and installation instructions.

### Select additional programme settings

By selecting additional settings, you can better adapt the washing process to your items of laundry.

The settings can be selected or deselected depending on the programme progress.

The indicator lamp for the button lights up if a setting is active.

The settings are not saved when the appliance is switched off.

→ "Additional programme settings" on page 15

Overview of programmes → Supplementary sheet for the operating and installation instructions.



## Placing laundry into the drum

### Warning

#### Danger of death!

Items of laundry pretreated with cleaning agents that contain solvents, e.g. stain remover/cleaning solvent, may cause an explosion after being loaded into the washing machine. Hand-rinse items of laundry thoroughly beforehand.

#### Notes

- Mix items of laundry of varying sizes. Laundry items of different sizes distribute themselves better during the spin cycle. Individual items of laundry may lead to imbalances.
  - Observe the specified maximum load. Overfilling has a negative impact on the washing result and promotes creasing.
1. Place presorted items of laundry unfolded in the washing drum.
  2. Make sure that no items of laundry are trapped between the washing machine door and the rubber seal, and close the door.

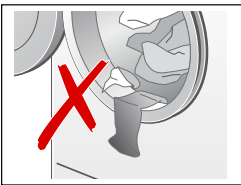

The  button indicator lamp flashes to indicate that the washing program can be started. It is possible to change the settings. → "Dyeing/bleaching" on page 12 → "Spin speed" on page 13

## Measure and add detergent and care products

### Caution!

#### Damage to the appliance

Cleaning agents and agents for pretreating laundry (e.g. stain removers, prewash sprays, etc.) may cause damage if they come into contact with the surfaces of the washing machine. Do not allow these agents to come into contact with the surfaces of the washing machine. If necessary, immediately wipe away spray residue and other residues/droplets with a damp cloth.

#### Measuring

Measure the detergent and care products according to:

- Water hardness; ask your water supply company
- The manufacturer's instructions on the packaging
- The amount of laundry
- Soiling

#### Filling

### Warning

#### Eye/skin irritation!

Detergent and care products may spray out if the detergent drawer is opened while the machine is in operation. Open the drawer carefully. Rinse eyes or skin thoroughly if they come into contact with detergent/care products. If swallowed accidentally, seek medical advice.

**Note:** Dilute viscous fabric softener and fabric conditioner with water; this prevents blockages.

## en Operating the appliance

Pour the detergent and care products into the appropriate compartments:

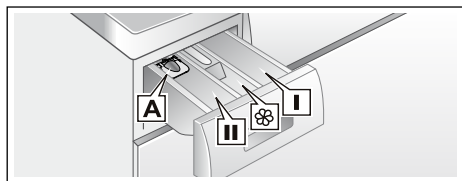

Measuring aid **A\*** For liquid detergent

Compartment **II** Detergent for the main wash, water softener, bleach, stain remover

Compartment  Fabric softener, starch  
Do not exceed the **max.**

Compartment **I** Detergent for prewash

1. Pull out the detergent drawer as far as possible.
2. Add detergent and/or care products.
3. Close the detergent drawer.

### Measuring aid\* for liquid detergent

\*depending on the model

Position the measuring aid for measuring the correct amount of liquid detergent:

1. Pull out the detergent drawer. Press down the insert and fully remove the drawer.
2. Slide the measuring aid forwards, fold it down and click it into place.
3. Reinsert the drawer.

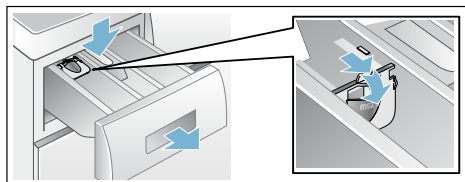

**Note:** Do not use the measuring aid for gel detergents and washing powder, or for programmes with prewash or when "Ready in" time is selected.

**For models without a measuring aid,** pour the liquid detergent into the appropriate dispenser and place it in the drum.

## Starting the programme

Press the  button. The indicator lamp lights up and the program starts.

The display panel shows the Ready in time while the program is running or the program duration and the program progress symbols once the wash cycle has started.

→ "Display panel" on page 9

### Note: Foam detection

If the  symbol also lights up in the display panel, the washing machine has detected too much foam during the wash cycle and automatically activated additional rinse cycles to remove the foam.

Add less detergent to the next wash cycle with the same load.



If you want to lock the program to prevent it from being inadvertently adjusted, you can select the childproof lock as follows.

## Childlock

( 3 sec.)

You can lock the washing machine to prevent the functions you have set from being changed inadvertently. To do this, **activate the childproof lock when the program has started.**

To **activate/deactivate**, press and hold the **Spin speed** and **Finished in-time** buttons at the same time after the washing program has started. Keep pressing the two buttons for approx. three seconds. The  symbol appears in the display panel.

-  lights up: The childproof lock is active.
-  flashes: The childproof lock is active and the program selector has been adjusted. To deactivate the childproof lock, reset the program selector to the initial program. The symbol lights up again.

**Note:** To avoid the program to terminate, do not turn the program selector beyond the Off position.

**Note:** The childproof lock remains active after the program has ended and the appliance is switched off. You must always deactivate the childproof lock if you want to start a new program.



## Adding/removing laundry

Following the start of the program, you can add or remove laundry as required.

Press the  button to do this.

The  button indicator lamp flashes and the machine checks whether it is possible to add laundry.

If the following appears in the display panel:



- The  symbol disappears: adding laundry is possible.
- The  symbol lights up: it is not possible to add laundry.

**To continue the program, press the button .** The program continues automatically.

## Notes



- Do not leave the door open for too long when adding laundry as water from the laundry may leak out.
- For safety reasons, the door remains locked when the water level or temperature is high, or while the drum is turning, and it is not possible to add laundry during this time.
- The load display is not active during reloading.

## Changing the programme





1. Press the  button.
2. Select another program.
3. Press the  button. The new program starts from the beginning.

## Cancel the programme

For programs at high temperature:

1. Press the  button.
2. To cool down laundry: Select  **Rinse**.
3. Press the  button.



For programs at low temperature:

1. Press the  button.
2. Select  **Spin/Drain**  **Spin/Empty** .
3. Press the  button.

## Programme end during rinse hold

----Ⓞ appears in the display panel and the indicator lamp of the ▷ button flashes.

Continue the program by:

- Pressing the ▷ button (the laundry will be drained with the default spin speed setting\*) or
- Selecting a spin speed or set the program selector to Ⓞ **Spin/Drain**  // Ⓞ **Spin/Empty**  and then pressing the ▷ button.

\* depending on the chosen program -> Overview of programmes

## Programme end

**End** appears in the display panel and the indicator lamp of the ▷ button is off.

## Removing laundry/switching off the appliance

1. Open the door and remove the laundry.
2. Turn the program selector to off position. The appliance is switched off.
3. Turn off the tap.

**Note:** Not required for Aqua-Stop models.

## Notes

- Always wait until the program ends, as the appliance could still be locked.
- If the display panel goes off at the end of a program, the energy-saving mode is active. Press any button to activate the panel.
- Do not leave any items of laundry in the drum. They may shrink in the next wash or discolour another item.
- Remove any foreign objects from the drum and the rubber seal – risk of rusting.
- Wipe the rubber seal dry.

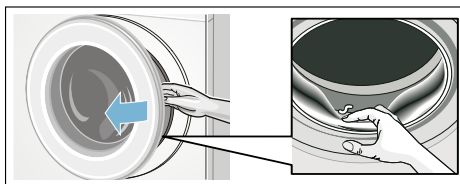

- Leave the door and detergent drawer open so that any residual water can evaporate.

## Sensors

### Automatic load sensing

The automatic load-sensing function perfectly adapts the water consumption to each programme depending on the type of fabric and the load.

### Unbalanced load detection system

The automatic unbalanced load detection system detects imbalances and ensures even distribution of the laundry by repeatedly starting and stopping the drum spinning.

If the laundry is extremely unevenly distributed, the spin speed is reduced or the spin cycle is not performed for safety reasons.

**Note:** Place large and small items of laundry evenly in the drum.  
→ *"Faults and what to do about them"* on page 26

### VoltMonitor

The automatic voltage control system detects an unacceptable low voltage supply. The colon on the Ready in display is flashing while there is an unacceptable undervoltage supply.

Once the supply voltage is stable again, the colon of the Ready in display lights up (Normal mode).

The detected voltage under-usage is indicated in the further program sequence by all three points lighting up in the display.



**Note:** Voltage under-usages can for example result in program extensions and/or non-satisfactory results.

## Setting the signal



You can change the following settings:

- The volume of the information signals (e.g. at the end of the program) and/or
- The volume of the button signals.

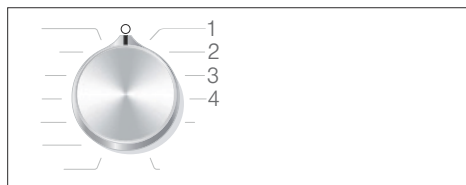
You will need to activate the setting mode in order to change these settings.



### Activating the setting mode

1. Select the **Cottons**  program at position 1. The washing machine is switched on.
2. Press the  button and, at the same time, turn the program selector clockwise to position 2. Release the button.

The setting mode is activated and the preset volume for the information signals appears in the display panel.

### Changing the volume

- To change the volume of the information signals, use the Finish in-time button, while the program selector remains at position 2.
- To change the volume of the button signals, rotate the program selector to position 3. Use again the Finish in-time button to change the volume.



0 = off, 1 = quiet,  
2 = medium, 3 = loud,  
4 = very loud

### Exiting setting mode

You can now end the process and set the program selector to the off position. The settings are saved.



## Cleaning and maintenance

### Warning

#### Danger of death!

There is a risk of electric shock if you touch live components. Switch off the appliance and unplug the mains plug.

### Warning

#### Risk of poisoning!

Toxic vapours can be produced by cleaning agents that contain solvents, e.g. cleaning solvent. Do not use cleaning agents that contain solvents.

### Caution!

#### Damage to the appliance

Cleaning agents that contain solvents, e.g. cleaning solvent, can damage surfaces and components in the machine. Do not use cleaning agents that contain solvents.

## Machine housing/control panel

- Wipe the housing and the control panel with a soft, damp cloth.
- Remove the detergent residue immediately.
- Do not clean with a water jet.

## Drum

Use chlorine-free cleaning agents, do not use steel wool.

If there are odours in the washing machine, or to clean the drum, run the **Drum Clean** / **Drum Clean** **90 °C** or **Cottons** **90 °C** program without laundry. Add washing powder. → *Faults and what to do about them" on page 26*

## Descaling

Descaling should not be necessary if the detergent is measured out correctly. However, if it is required, follow the manufacturer's instructions for the descaling agent. Suitable descalers can be obtained via our website or from our after-sales service. → *Page 31*

## Detergent drawer and housing

If the washing machine contains detergent or fabric softener residues:

1. Pull out the detergent drawer. Press down the insert and fully remove the drawer.
2. To remove the insert: Push the insert upwards from below with your finger.

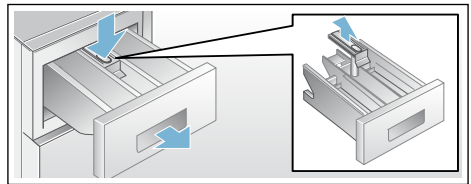

3. Clean the detergent dispenser tray and insert with water and a brush, and dry it. Clean the inside of the housing as well.
4. Fit the insert and lock it in place (push the cylinder onto the guide pin).
5. Push in the detergent drawer.

**Note:** Leave the detergent drawer open so that any residual water can evaporate.

## Detergent solution pump blocked

**⚠ Warning**  
**Risk of scalding!**

When you wash at high temperatures, the water gets very hot. If you come into contact with the hot water, you may be scalded.

Allow the water to cool down.

### After the water has cooled down:

1. Turn off the water tap so that no more water can flow in and has to be drained via the drain pump.
2. Switch off the appliance.
3. Disconnect the mains plug.
4. Open and remove the service flap.

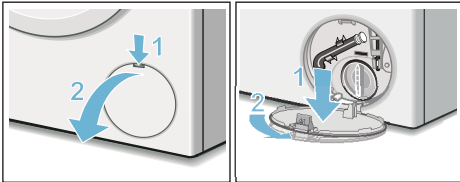

5. Take the drain hose out of the retainer. Remove the sealing cap, allow the water to flow out into a suitable container. Replace the sealing cap and place the drainage hose in the retainer.

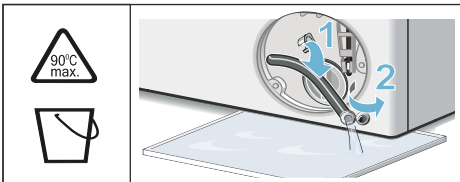

6. Carefully unscrew the pump cover, residual water may leak out. Clean the interior, pump cover thread and pump housing. The impeller in the detergent solution pump must be able to rotate. Refit the pump cover and screw it on tightly. The handle must be in a vertical position.

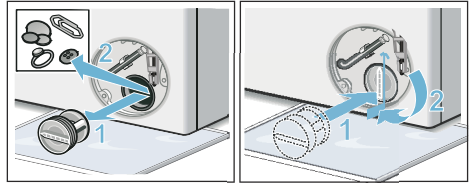

7. Place the service flap back on, lock it into place, and close it.

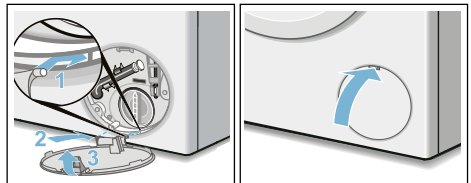

**Note:** To prevent unused detergent from flowing straight into the drain during the next wash, pour 1 litre of water (without detergent) into compartment II and start the **Spin/Drain** or **Spin/Empty** programme. Do the next wash as usual.



## The drain hose at the siphon is blocked

1. Switch off the appliance.
2. Disconnect the mains plug.
3. Loosen the hose clamp. Carefully remove the drain hose; residual water may leak out.
4. Clean the drain hose and siphon connecting piece.

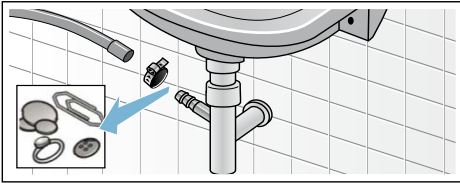

5. Reattach the drain hose and secure the connection using the hose clamp.

## Filter in the water supply is blocked

First, reduce the water pressure in the supply hose:

1. Turn off the tap.
2. Select any program (except Spin/Drain Spin/Empty ).
3. Press the button. Allow the program to run for approximately 40 seconds.
4. Turn the program selector to off position.
5. Pull out the mains plug.
6. Clean the filter on the tap: Disconnect the hose from the tap. Clean the filter with a small brush.

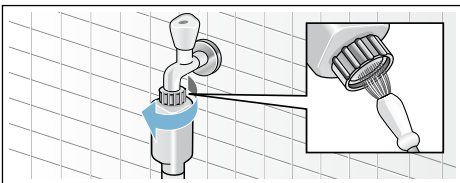

7. For standard and Aqua-Secure models, clean the filter on the rear of the appliance: Remove the hose from the rear of the appliance. Use pliers to remove the filter and then clean it.

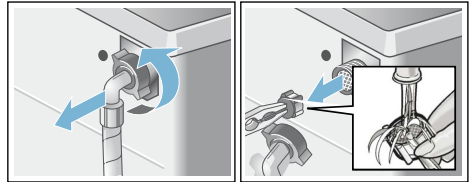

8. Insert the filter, connect the hose and check for leaks.

## Faults and what to do about them

### Emergency release

e.g. in the event of a power outage

**Note:** The programme will continue running when the power supply has been restored.

 **Warning**  
**Risk of scalding!**

When you are washing at high temperatures, there is a risk of scalding if you come into contact with detergent solution and laundry. If possible, leave it to cool down.

 **Warning**  
**Risk of injury!**

You may injure your hands if you reach into the drum while it is turning. Do not reach into the drum when it is turning. Wait until the drum has stopped turning.

**Caution!**  
**Water damage**





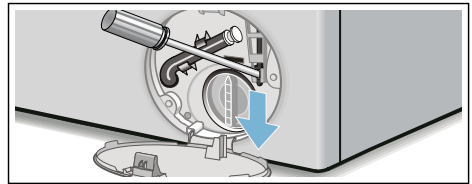

Any escaping water may cause water damage. Do not open the washing machine door if water can be seen through the glass.



**If the laundry has to be removed, the washing machine door can be opened as follows:**

1. Switch off the appliance.
2. Disconnect the mains plug.
3. Drain the water. → *Page 24*
4. Pull the emergency release downwards with a tool and release. The washing machine door can now be opened.











## Information on the display panel



Display	Cause/Remedy
 lights up (after program start)	The door is locked.
 lights up (in pause mode)	<ul style="list-style-type: none"> <li>■ The water level is too high. It is not possible to add laundry.</li> <li>■ The drum is still turning. It is not possible to add laundry.</li> </ul> <p><b>Note:</b> If the door lock symbol is off in pause mode, the door is unlocked. It is possible to add laundry</p>
 flashes	<ul style="list-style-type: none"> <li>■ Laundry may be caught. Open and close the door again and press the  button.</li> <li>■ If necessary, push the door closed or remove some laundry and then push it closed again.</li> <li>■ If necessary, switch the appliance off and on again; set the program and make your individual settings; start the program.</li> </ul>
 flashes	<ul style="list-style-type: none"> <li>■ No water inlet, turn on the water tap fully                             <ul style="list-style-type: none"> <li>- Supply hose kinked/trapped,</li> <li>- Clean the filter in the water supply.</li> <li>- If an additional water filter has been installed (depending on model), check for contaminants and clean if required → separate installation and cleaning instruction for water filter.</li> </ul> </li> </ul>
 lights up	<ul style="list-style-type: none"> <li>■ The water pressure is too low.                             <ul style="list-style-type: none"> <li>- Supply hose kinked/trapped,</li> <li>- Clean the filter in the water supply.</li> <li>- If an additional water filter has been installed (depending on model), check for contaminants and clean if required → separate installation and cleaning instruction for water filter.</li> </ul> </li> </ul> <p><b>Note:</b> The program is taking longer than usual.</p>
E:18	<ul style="list-style-type: none"> <li>■ The drain pump is blocked. Clean the drain pump → <i>Page 24</i></li> <li>■ The drain hose/drain pipe is blocked. Clean the drain hose at the siphon. → <i>Page 25</i></li> </ul>

Display	Cause/Remedy
E:23	There is water in the base trough, the appliance is leaking. Turn off the tap. Call customer services! → <i>Page 31</i> (failure will only be detected at machines with Aquastop)
E:32	at program end Not a fault – the unbalanced load detection system has interrupted the spin cycle because the laundry is unevenly distributed. Distribute small and large items of laundry evenly in the drum. If necessary, start an additional spin program.
	The childproof lock is activated – deactivate it. → <i>Page 18</i>
 lights up	Too much foam has been detected and an additional wash cycle has been activated. Add less detergent to the next wash cycle with the same load. → <i>Page 28</i>
: of the 'Ready in' time flashes	Mains voltage is too low. The program will continue after the voltage supply is recovered.
. of the 'Ready in' time lights up	Undervoltage in the wash programme. The programme is extended. → <i>Page 21</i>
Other displays	Switch off the appliance, wait for five seconds and then switch it on again. If the display appears again, call customer services. → <i>Page 31</i>

## Faults and what to do about them.

Faults	Cause/Remedy
Water is leaking from the machine.	<ul style="list-style-type: none"> <li>■ Attach the drain hose correctly or replace it.</li> <li>■ Tighten the screw connection of the drain hose.</li> </ul>
The machine is not filling with water. Detergent is not being dispensed.	<ul style="list-style-type: none"> <li>■ Have you pressed the  button?</li> <li>■ Is the tap turned on?</li> <li>■ Could the filter be clogged? Clean the filter. → <i>Page 25</i> <b>Note:</b> If an additional water filter has been installed (depending on model), check for contaminants and clean if required → separate installation and cleaning instruction for water filter.</li> <li>■ Is the supply hose kinked or trapped?</li> </ul>
The door cannot be opened.	<ul style="list-style-type: none"> <li>■ The safety function is activated. <b>Note:</b> For safety reasons, the washing machine door remains locked when the water level or temperature is high (See → <i>Cancel the programme</i> → <i>Page 19</i>) or while the drum is rotating.</li> <li>■ Is ---- selected (Rinse Stop = no final spin, water level is high)? → <i>Page 20</i></li> <li>■ Can the door only be opened by the emergency release? → <i>Page 26</i></li> </ul>
The program will not start.	<ul style="list-style-type: none"> <li>■ Have you pressed the  or <b>Finished in-time</b> button?</li> <li>■ Is the door closed?</li> <li>■ Is the  childproof lock activated? Deactivate. → <i>Page 18</i></li> </ul>
The drum briefly jerks or judders after the program has started.	Not a fault – the internal motor test may cause the drum to jerk or judder briefly when the wash program starts.

Faults	Cause/Remedy
The water is not draining.	<ul style="list-style-type: none"> <li>■ Is ---- selected (Rinse Stop = no final spin)? → <i>Page 20</i></li> <li>■ Clean the drain pump. → <i>Page 24</i></li> <li>■ Clean the drain pipe and/or the drain hose. → <i>Page 25</i></li> </ul>
Water is not visible in the drum.	Not a fault – the water is below the visible area.
The spin result is not satisfactory. Laundry is wet/too damp.	<ul style="list-style-type: none"> <li>■ Not a fault – the unbalanced load detection system has interrupted the spin cycle because the laundry is unevenly distributed. Distribute small and large items of laundry evenly in the drum.</li> <li>■ Less iron (depending on the model) selected? → <i>Page 15</i></li> <li>■ Is the selected speed too low?</li> <li>■ You may run the program Spin/Drain to spin the laundry again.</li> </ul>
The spin cycle runs several times.	Not a fault – the unbalanced load detection system is adjusting an imbalance.
The program is taking longer than usual.	<ul style="list-style-type: none"> <li>■ The water pressure is too low,  lights up → <i>Page 27</i></li> <li>■ Not a fault – the unbalanced load detection system is adjusting an imbalance by repeatedly distributing the laundry in case imbalances have been detected.</li> <li>■ Not a fault – the foam detection is active – a rinse cycle has been switched on in case foam has been detected.</li> </ul>
The length of the program changes during the wash cycle.	<ul style="list-style-type: none"> <li>■ Not a fault – the program sequence is optimised for the specific washing process according to the load and the type of textiles. This may change the length of the program shown in the display panel.</li> <li>■ The water pressure is low - the washing program will take longer as usual</li> </ul>
Residual water in the care-product compartment  .	<ul style="list-style-type: none"> <li>■ Not a fault – the effect of the care product is not affected.</li> <li>■ Clean the insert if necessary.</li> </ul>
Odours in the washing machine.	<p>Depending on the model, run the <b>Drum Clean</b> /Drum Clean  or <b>Cottons</b>  <b>90 °C</b> program without laundry.</p> <p>Add washing powder or a detergent containing bleach.</p> <p><b>Note:</b> To prevent foaming, only use half the amount of detergent recommended by the detergent manufacturer. Do not use detergents designed for wool or delicates.</p>

Faults	Cause/Remedy
Foam is leaking from the detergent drawer. Foam is visible in the drum	<p>The  symbol lights up in the display panel.</p> <ul style="list-style-type: none"> <li>■ Have you used too much detergent? Use less detergent in the next wash cycle.</li> <li>■ Mix one tablespoon of fabric softener with 1/2 litre of water and pour it into compartment II (not suitable for outdoor clothing, sportswear or items stuffed with down).</li> </ul>
Loud noises, vibrations and machine "movement" during the spin cycle.	<ul style="list-style-type: none"> <li>■ Is the appliance aligned? Align the appliance. → <i>Page 37</i></li> <li>■ Are the appliance's feet fixed? Secure the appliance's feet. → <i>Page 37</i></li> <li>■ Have the transport locks been removed? Remove the transport locks. → <i>Page 34</i></li> </ul>
The display panel/indicator lights do not work while the appliance is running.	<ul style="list-style-type: none"> <li>■ Has there been a power failure?</li> <li>■ Have the fuses blown? Reset/replace the fuses.</li> <li>■ If the fault occurs repeatedly, call customer services.</li> <li>■ End of program reached. Energy-saving mode is activated</li> </ul>
There is detergent residue on the laundry.	<ul style="list-style-type: none"> <li>■ Some phosphate-free detergents contain water-insoluble residue.</li> <li>■ Select the program  <b>Rinse</b> or brush the laundry after washing.</li> </ul>
<p>If you cannot rectify a fault yourself (after switching the machine off and on again) or a repair is required:</p> <ul style="list-style-type: none"> <li>■ Switch off the appliance and pull out the mains plug.</li> <li>■ Turn off the tap and call customer services. → <i>Page 31</i></li> </ul>	



## After-sales service

If you cannot correct the fault yourself → "*Faults and what to do about them*" on page 26 please contact our after-sales service. → Back page

We will always find an appropriate solution in order to avoid unnecessary visits by engineers.

Please give the after-sales service the product number (E no.) and the production number (FD) of the appliance.

E-Nr. \_\_\_\_\_ FD \_\_\_\_\_

Product number

Production number

### You can find this information:

- on the inside of the washing machine door\*
- in the opened service flap\*
- on the rear of the appliance\*

\*depending on the model

### Trust the expertise of the manufacturer.

Contact us for assistance. By doing so, you will ensure that the repairs are carried out by trained service personnel using genuine spare parts.



## Technical data

### Dimensions:

850 x 600 x 590 mm  
(Height x width x depth)

### Weight

63-83 kg (depending on model)

### Mains connection:

Mains voltage 220-240 V, 50 Hz

Nominal current 10 A

Nominal input 1900-2300 W

### Water pressure:

100-1000 kPa (1-10 bar)



## Positioning and connecting

### Included with the appliance

**Note:** Check the machine for transport damage. Never use a damaged machine. If you have a complaint, please contact the retailer from whom you purchased the appliance, or our after-sales service.

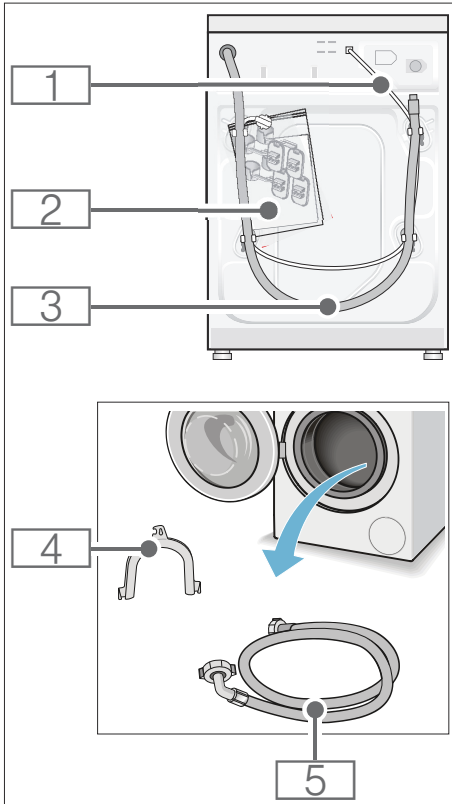

1 Mains cable

- 2 Bag:
  - Installation and operating instructions
  - After-sales service location directory\*
  - Warranty\*
  - Cover caps for openings left after removing the transport locks
  - Wrench\*
  - liquid detergent insert\*
  - external water filter\*
- 3 Water drain hose
- 4 Elbow for securing the water drain hose\*
- 5 Water supply hose on standard/Aqua-Secure models
  - \*depending on the model

**In addition,** a hose clamp (24 - 40 mm diameter, available from specialist dealers) is required to connect the water drain hose to a siphon.

### Useful tools

- Spirit level for levelling
- Wrench with:
  - WAF 13 for loosening the transport locks, and
  - WAF 17 for aligning the appliance feet



## Safety instructions

### **Warning**

#### **Risk of injury!**

- The washing machine is very heavy. Be careful when lifting/transporting the washing machine.
- When the washing machine is lifted by its protruding parts (e.g. the washing machine door), the components may break off and cause injuries. Do not lift the washing machine by protruding parts.
- If the hose and mains cables are not routed properly, there is a risk of tripping and injury. Lay hoses and cables in such a way that there is no risk of tripping.

### **Caution!**

#### **Damage to the appliance**

Frozen hoses may rip/burst. Do not install the washing machine in areas exposed to frost or outdoors.

### **Caution!**

#### **Water damage**

The connection points for the water supply hose and water drain hose are under high water pressure. To prevent leaks and water damage, you must follow the instructions in this section.

### **Notes**

- In addition to the safety information listed here, the local water and electricity supplier may have special requirements.
- If in doubt, have the appliance connected by a specialist.

## Installation surface

**Note:** The washing machine must be aligned in a stable manner so that it does not move around.

- The installation surface must be firm and level.
- Soft floors/floor coverings are not suitable.

## Installation on a base or a wooden joist floor

### **Caution!**

#### **Damage to the appliance**

The washing machine may "wander" and tip/topple from the base when spinning.

The feet of the appliance must be secured with holding brackets.

Order no. WMZ 20490, WZ 20490 WZ 20510, WZ 20520

**Note:** On wooden joist floors, install the washing machine:

- In a corner, if possible,
- On a water-resistant wooden board (min. 30 mm thick) which is screwed tightly to the floor.

## Installation on a platform with drawer

Platform order no.: WMZ 20490, WZ 20490, WZ 20510, WZ 20520

## Installing the appliance in a kitchenette

### **Warning** **Risk of death!**

There is a risk of electric shock if you touch live components. Do not remove the appliance covering plate.

### Notes

- Recess width of 60 cm required.
- Only install the washing machine underneath a continuous worktop that is securely connected to adjacent cabinets.

## Removing the transport locks

### **Caution!** **Damage to the appliance**

- The machine is secured for transportation using transport locks. If the transport locks are not removed, the machine may become damaged when it is operated. Before using the appliance for the first time, make sure that you completely remove all four transport locks. Keep the locks in a safe place.
- To prevent transport damage from occurring if the appliance is moved at a later date, you must refit the transport locks before transporting the appliance.

**Note:** Keep the screws and sleeves in a safe place.

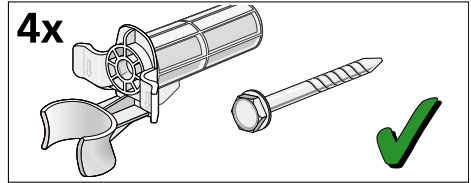

1. Take the hoses out of the holders.

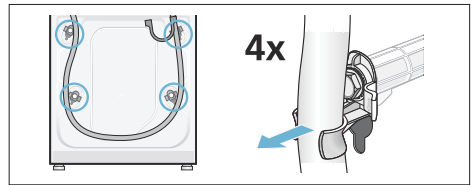

2. Unscrew and remove all four transport brace screws. Remove the sleeves. To do this, remove the mains cable from the holders.

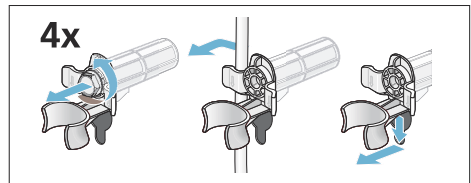

3. Fit the covers. Lock the covers firmly in place by applying pressure to the snap-in hooks.

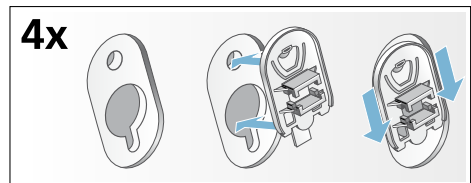

## Hose and cable lengths

### ■ Left-hand connection

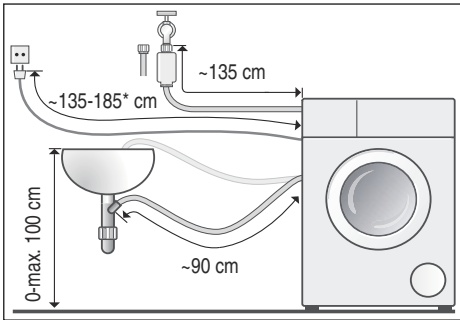

### ■ Right-hand connection

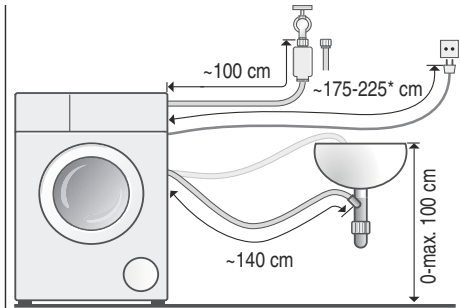

\* depending on model

**Tip:** The following are available from specialist dealers/the after-sales service:

- An extension for Aqua-Stop or cold water supply hose (approx. 2.50 m); order no. WMZ2380, WZ10130, CZ11350, Z7070X0
- A longer supply hose (approx. 2.20 m) for standard model

## Water inlet

### **⚠ Warning** **Risk of death!**

There is a risk of electric shock if you touch live components.

Observe the following when connecting the machine:

### Notes

- Only operate the washing machine using cold mains water.
- Do not connect the machine to the mixer tap of an unpressurised hot-water boiler.
- Do not use a used supply hose. Only use the supply hose supplied with the machine or one that was purchased from an authorised retailer.
- Do not bend, squash, modify or cut through the water supply hose (otherwise its strength is no longer guaranteed).
- Only tighten the screw connections by hand. If the screw connections are tightened too much with a tool (pliers), the thread may be damaged.

### Optimum water pressure in the supply network

**At least** 100 kPa (1 bar)

**Maximum** 1000 kPa (10 bar)

When the tap is open, the water flow is at least 8 l/min.

If the water pressure is higher than this, a pressure-reducing valve must be installed.

## Connection

1. Connect the water supply hose to the water tap ( $\frac{3}{4}$ " = 26.4 mm) and to the appliance:
  - Model: **Standard**

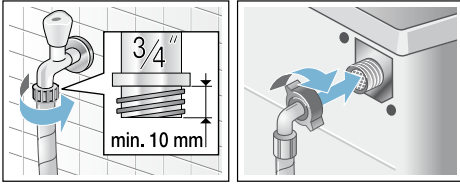

- Model: **Aqua-Secure**

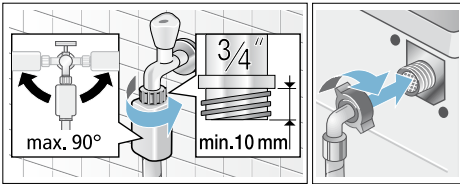

2. Open the water tap carefully, checking the leak tightness of the connection points. The screw connection is under mains water pressure.

## Water outlet

### Caution! Water damage

If the drain hose slips out of the wash basin or the connection point during draining due to high water pressure, any escaping water may cause water damage. Secure the drain hose so that it cannot slip out.

**Note:** Do not kink the water drain hose or put strain on it lengthways.

You can lay the water drain hose as follows:

### ■ Outlet in a sink

#### **Warning** **Risk of scalding!**

When you are washing at high temperatures, there is a risk of scalding if you come into contact with hot water e.g. if hot water is being drained into a wash basin. Do not reach into the hot water.

#### **Caution!**

#### **Damage to the appliance/fabrics**

If the end of the drain hose is immersed in the drained water, water may be sucked back into the appliance and may damage the appliance/fabrics.

Make sure that:

- The plug does not block drainage from the sink.
- The end of the drain hose is not immersed in the drained water.
- The water drains away quickly enough.

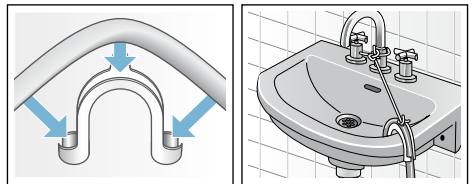

### ■ Drainage into a siphon

The connection point must be secured using a hose clamp with a diameter of 24-40 mm (available from specialist dealers).

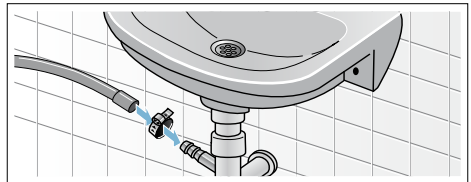

- **Outlet into a plastic pipe with rubber bushing or into a drainage pit**

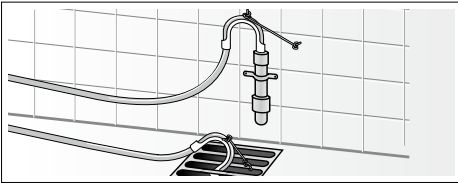

## Levelling

Level the appliance using a spirit level. Incorrect levelling may result in intense noise, vibrations and "wandering".

1. Loosen the lock nuts using a wrench, by turning it in a clockwise direction.
2. Check the alignment of the washing machine with a spirit level, and adjust it if necessary. Change the height by turning the appliance feet. All four appliance feet must stand firmly on the ground.
3. Tighten the lock nut against the housing.  
In doing so, hold the foot tight and do not adjust its height. The lock nuts on all four appliance feet must be screwed tightly against the housing.

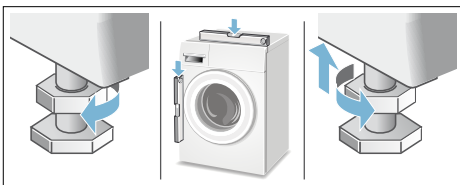

## Electrical connection

### **Warning** **Danger of death!**

There is a risk of electric shock if you touch live components.

- Never touch or hold the mains plug with wet hands.
- Only pull out the mains cable by the plug and never by the cable, as this could damage it.
- Never unplug the mains plug during operation.

Observe the following information and ensure that:

### Notes

- The mains voltage and voltage indicated on the washing machine (rating plate) are the same. The connected load and fuse required are specified on the rating plate.
- The mains plug fits the socket.
- The cable cross-section is adequate.
- The mains cable is only replaced by a qualified electrician (if this is necessary). Replacement mains cables are available from the after-sales service.
- No multiple plugs/couplings or extension cables are used.
- If an earth-leakage circuit breaker is used, only a type which displays this symbol is used: . Only this symbol guarantees compliance with the currently applicable regulations.
- The mains plug can be accessed at all times.
- The mains cable is not bent, squashed, modified, cut through, or in contact with heat sources.

## Grounding Instructions

### **Warning** **Danger of death!**

Improper connection of the ground may result in electric shock. Have the appliance checked by a qualified technician or licensed electrician if you are in doubt as to whether the washing machine has been properly grounded.

This appliance must be grounded. In the event of malfunction or breakdown, grounding will reduce the risk of electric shock by providing a path of least resistance for the electric current. This appliance is equipped with a cord that has an equipment grounding conductor and a grounding plug. The plug must be plugged into an appropriate outlet that is properly installed and grounded in accordance with local codes and ordinances. To ground the appliance use a 3 pin plug and properly grounded socket of 16 A rating.





### Notes

- Do not modify the plug provided with the appliance. If the plug will not fit into outlet have a properly grounded outlet installed by qualified electrician. Do not cut, remove or bypass the grounding prong on the washing machine power cord plug.
- The wiring for the electrical outlet circuit must be sufficient to meet the appliance requirements. Use of Ground Fault Circuit Interrupter (GFCI) is recommended.
- Do not use the machine with an extension box, extension cord, spike busters etc., as this may lead to improper grounding conditions.

## Before washing for the first time

The washing machine was thoroughly tested before leaving the factory. To remove any residues from the production and to remove water that may be left over from the test, run the first wash cycle **without** any laundry.

### Notes

- The washing machine **must be correctly installed and connected.** → Page 32
  - Never use a damaged machine. Inform customer services.
1. Check the machine.
  2. Remove the protective foil from the work top and the control panel.
  3. Connect the mains plug.
  4. Turn on the tap.
  5. Close the door (do not load any laundry).
  6. Depending on the model, select **Drum Clean** /**Drum Clean**   
**90 °C** or **Cottons**  **90 °C** program.
  7. Open the detergent drawer.
  8. Pour approximately 1 litre of water into compartment **II**.
  9. Pour standard detergent into compartment **II**.  
**Note:** To prevent foaming, only use half the amount of detergent recommended by the detergent manufacturer. Do not use detergent designed for wool or delicates.
  10. Close the detergent drawer.
  11. Press the  button.
  12. When the program ends, switch off the appliance.

**Your washing machine is now ready to use.**

## Transportation

e.g. when moving home

### Preparatory work:

1. Turn off the water tap.
2. Reduce the water pressure in the supply hose.  
Maintenance – filter in the water supply → *Page 25*
3. Disconnect the washing machine from the main plug.
4. Drain the remaining detergent solution.  
Maintenance – detergent solution pump blocked → *Page 24*
5. Remove the hoses.

### Installing the transport locks:

1. Remove the covers and keep them in a safe place.  
Use a screwdriver if necessary.

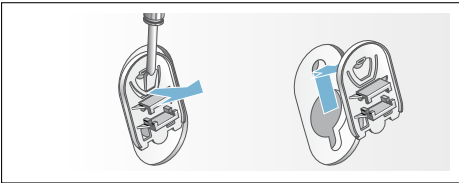

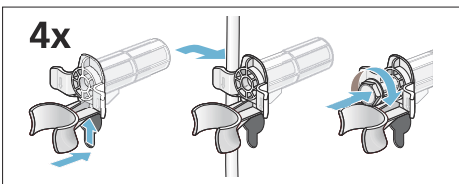

2. Insert all four sleeves.  
Clip the mains cable securely in the holders. Insert and tighten the screws.



### Before switching on the appliance again:

#### Notes

- The transport locks **must** be removed. → *"Removing the transport locks" on page 34*
- To prevent unused detergent from flowing straight into the drain during the next wash: Pour approx. 1 litre of water into compartment **II** and start the **Spin/Drain**  **Spin/Empty**  program.

## **Repair order and advice in the event of faults**

GB 0344 892 8999 (Calls charged at local or mobile rate.)

IE 01450 2655 (0.03 € per minute at peak. Off peak 0.0088 € per minute.)

You can find the contact information for all countries in the attached after-sales service directory.

Manufactured by BSH Hausgeräte GmbH under Trademark License of Siemens AG

BSH Hausgeräte GmbH

Carl-Wery-Straße 34

81739 München

GERMANY

[siemens-home.com](http://siemens-home.com)

Manufactured by BSH Hausgeräte GmbH under Trademark License of Siemens AG



9001034565 (9510)