

SIEMENS



Built-in oven

HB673G0.1A

siemens-home.bsh-group.com/welcome

en Instruction manual

Register
your
product
online

Table of contents

 Intended use	4	 Sabbath mode	17
		Starting Sabbath mode.	17
 Important safety information	5	 Cleaning function	17
General information	5	Prior to initiating the cleaning function	17
Halogen lamp.	5	Setting the self-cleaning function	18
Cleaning function	6	Once the cleaning function has ended.	18
 Causes of damage	6	 Cleaning	18
General information	6	Suitable cleaning agents	18
 Environmental protection	7	Keeping the appliance clean	19
Saving energy	7	 Rails	20
Environmentally-friendly disposal	7	Detaching and refitting the rails	20
 Getting to know your appliance	8	 Appliance door	20
Control panel	8	Removing and fitting the appliance door	20
Controls	8	Removing the door cover.	21
Display	8	Removing and installing the door panels	21
Operating modes menu	9	 Trouble shooting	23
Types of heating.	9	Fault table.	23
Further information.	10	Maximum operating time exceeded	23
Cooking compartment functions	10	Replacing the bulb in the top of the cooking compartment	23
 Accessories	10	Glass cover	24
Accessories included.	10	 Customer service	24
Inserting accessories	11	E number and FD number	24
Optional accessories	11	 Dishes	24
 Before using for the first time	12	Information on the setting.	24
Initial use	12	Selecting a dish	24
Cleaning the cooking compartment and accessories	12	Applying settings for dishes	25
 Operating the appliance	13	 Tested for you in our cooking studio	25
Switching the appliance on and off	13	Silicone moulds	25
Starting or interrupting operation	13	Cakes and small baked items	25
Selecting an operating mode.	13	Bread and rolls.	29
Setting the type of heating and temperature	13	Pizza, quiche and savoury cakes	30
Rapid heat up	14	Bakes and soufflés.	32
 Time-setting options	14	Poultry	33
Timer	14	Meat	34
Cooking time	15	Fish.	37
End time.	15	Vegetables and side dishes	38
 Childproof lock	16	Yogurt.	39
Activating and deactivating	16	Eco heating functions.	39
The appliance door is locked.	16	Acrylamide in foodstuffs	41
 Basic settings	16	Drying	41
Changing settings	16	Preserving	42
List of settings	16	Prove dough.	43
Changing the time	16	Defrosting	43
		Keeping warm	44
		Test dishes	44

Additional information on products, accessories, replacement parts and services can be found at www.siemens-home.bsh-group.com and in the online shop www.siemens-home.bsh-group.com/eshops

Intended use

Read these instructions carefully. Only then will you be able to operate your appliance safely and correctly. Retain the instruction manual and installation instructions for future use or for subsequent owners.

This appliance is only intended to be fully fitted in a kitchen. Observe the special installation instructions.

Check the appliance for damage after unpacking it. Do not connect the appliance if it has been damaged in transport.

Only a licensed professional may connect appliances without plugs. Damage caused by incorrect connection is not covered under warranty.

This appliance is intended for domestic use only. The appliance must only be used for the preparation of food and drink. The appliance must be supervised during operation. Only use this appliance indoors.

This appliance is intended for use up to a maximum height of 4000 metres above sea level.

This appliance may be used by children over the age of 8 years old and by persons with reduced physical, sensory or mental capabilities or by persons with a lack of experience or knowledge if they are supervised or are instructed by a person responsible for their safety how to use the appliance safely and have understood the associated hazards.

Children must not play with, on, or around the appliance. Children must not clean the appliance or carry out general maintenance unless they are at least 15 years old and are being supervised.

Keep children below the age of 8 years old at a safe distance from the appliance and power cable.

Always slide accessories into the cooking compartment the right way round.

→ "Accessories" on page 10

Important safety information

General information

Warning – Risk of fire!

- Combustible items stored in the cooking compartment may catch fire. Never store combustible items in the cooking compartment. Never open the appliance door if there is smoke inside. Switch off the appliance and unplug it from the mains or switch off the circuit breaker in the fuse box.
- Loose food remnants, fat and meat juices may catch fire. Before using the appliance, remove the worst of the food remnants from the cooking compartment, heating elements and accessories.
- A draught is created when the appliance door is opened. Greaseproof paper may come into contact with the heating element and catch fire. Do not place greaseproof paper loosely over accessories during preheating. Always weight down the greaseproof paper with a dish or a baking tin. Only cover the surface required with greaseproof paper. Greaseproof paper must not protrude over the accessories.

Warning – Risk of burns!

- The appliance becomes very hot. Never touch the interior surfaces of the cooking compartment or the heating elements. Always allow the appliance to cool down. Keep children at a safe distance.
- Accessories and ovenware become very hot. Always use oven gloves to remove accessories or ovenware from the cooking compartment.
- Alcoholic vapours may catch fire in the hot cooking compartment. Never prepare food containing large quantities of drinks with a high alcohol content. Only use small quantities of drinks with a high alcohol content. Open the appliance door with care.

Warning – Risk of scalding!

- The accessible parts become hot during operation. Never touch the hot parts. Keep children at a safe distance.
- When you open the appliance door, hot steam can escape. Steam may not be visible, depending on its temperature. When opening, do not stand too close to the appliance. Open the appliance door carefully. Keep children away.

- Water in a hot cooking compartment may create hot steam. Never pour water into the hot cooking compartment.

Warning – Risk of injury!

- Scratched glass in the appliance door may develop into a crack. Do not use a glass scraper, sharp or abrasive cleaning aids or detergents.
- The hinges on the appliance door move when opening and closing the door, and you may be trapped. Keep your hands away from the hinges.

Warning – Risk of electric shock!

- Incorrect repairs are dangerous. Repairs may only be carried out and damaged power cables replaced by one of our trained after-sales technicians. If the appliance is defective, unplug the appliance from the mains or switch off the circuit breaker in the fuse box. Contact the after-sales service.
- The cable insulation on electrical appliances may melt when touching hot parts of the appliance. Never bring electrical appliance cables into contact with hot parts of the appliance.
- Do not use any high-pressure cleaners or steam cleaners, which can result in an electric shock.
- A defective appliance may cause electric shock. Never switch on a defective appliance. Unplug the appliance from the mains or switch off the circuit breaker in the fuse box. Contact the after-sales service.

Warning – Hazard due to magnetism!

Permanent magnets are used in the control panel or in the control elements. They may affect electronic implants, e.g. heart pacemakers or insulin pumps. Wearers of electronic implants must stay at least 10 cm away from the control panel.

Halogen lamp

Warning – Risk of burns!

The bulbs in the cooking compartment become very hot. There is still a risk of burning your skin for some time after they have been switched off. Do not touch the glass cover. Avoid contact with your skin when cleaning.

Warning – Risk of electric shock!

When replacing the cooking compartment bulb, the bulb socket contacts are live. Before

replacing the bulb, unplug the appliance from the mains or switch off the circuit breaker in the fuse box.

Cleaning function

Warning – Risk of fire!

- Loose food residues, grease and meat juices may catch fire during the cleaning function. Before starting the cleaning function, remove coarse dirt from the cooking compartment and from the accessories.
- The appliance will become very hot on the outside during the cleaning function. Never hang combustible objects, e.g. tea towels, on the door handle. Do not place anything against the front of the appliance. Keep children away from the appliance.

Warning – Risk of serious damage to health!

The appliance will become very hot during the cleaning function. The non-stick coating on baking trays and tins is destroyed and noxious gases are released. Never clean non-stick baking trays and baking tins using the cleaning function. Only clean enamelled accessories using the cleaning function.

Warning – Risk of harm to health!

The cleaning function heats up the cooking compartment to a very high temperature so that food remnants left over from roasting, grilling and baking will burn off. This process releases vapours, which can irritate the mucous membranes. While the cleaning function is running, keep the kitchen well ventilated. Do not remain in the room for long periods. Keep children and pets away. Follow the instructions even when using the Delayed start function with a delayed end time.

Warning – Risk of burns!

- The cooking compartment becomes extremely hot during the cleaning function. Never open the appliance door. Allow the appliance to cool down. Keep children away from the appliance.
-  The appliance will become very hot on the outside during the cleaning function. Never touch the appliance door. Allow the appliance to cool down. Keep children away from the appliance.

Causes of damage

General information

Caution!

- Accessories, foil, greaseproof paper or ovenware on the cooking compartment floor: do not place accessories on the cooking compartment floor. Do not cover the cooking compartment floor with any sort of foil or greaseproof paper. Do not place ovenware on the cooking compartment floor if a temperature of over 50 °C has been set. This will cause heat to accumulate. The baking and roasting times will no longer be correct and the enamel will be damaged.
- Aluminium foil: Aluminium foil in the cooking compartment must not come into contact with the door glass. This could cause permanent discolouration of the door glass.
- Water in a hot cooking compartment: do not pour water into the cooking compartment when it is hot. This will cause steam. The temperature change can cause damage to the enamel.
- Moisture in the cooking compartment: Over an extended period of time, moisture in the cooking compartment may lead to corrosion. Allow the cooking compartment to dry after use. Do not keep moist food in the closed cooking compartment for extended periods of time. Do not store food in the cooking compartment.
- Cooling with the appliance door open: Following operation at high temperatures, only allow the cooking compartment to cool down with the door closed. Do not trap anything in the appliance door. Even if the door is only left open a crack, the front of nearby furniture may become damaged over time. Only leave the cooking compartment to dry with the door open if a lot of moisture was produced whilst the oven was operating.
- Fruit juice: when baking particularly juicy fruit pies, do not pack the baking tray too generously. Fruit juice dripping from the baking tray leaves stains that cannot be removed. If possible, use the deeper universal pan.
- Extremely dirty seal: If the seal is very dirty, the appliance door will no longer close properly during operation. The fronts of adjacent units could be damaged. Always keep the seal clean.
→ "Cleaning" on page 18
- Appliance door as a seat, shelf or worktop: Do not sit on the appliance door, or place or hang anything on it. Do not place any cookware or accessories on the appliance door.
- Inserting accessories: depending on the appliance model, accessories can scratch the door panel when closing the appliance door. Always insert the accessories into the cooking compartment as far as they will go.
- Carrying the appliance: do not carry or hold the appliance by the door handle. The door handle cannot support the weight of the appliance and could break.

Environmental protection

Your new appliance is particularly energy-efficient. Here you can find tips on how to save even more energy when using the appliance, and how to dispose of your appliance properly.

Saving energy

- Only preheat the appliance if this is specified in the recipe or in the tables in the operating instructions.
- Leave frozen food to defrost before placing it in the cooking compartment.

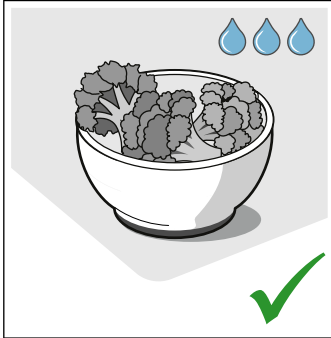
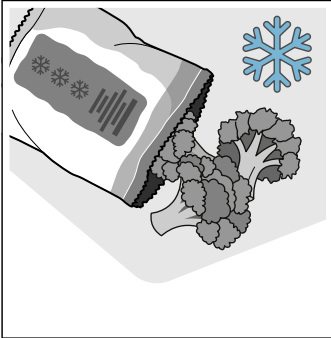

- Use baking tins that are dark-coloured, painted black or have an enamel coating. These absorb the heat particularly well.

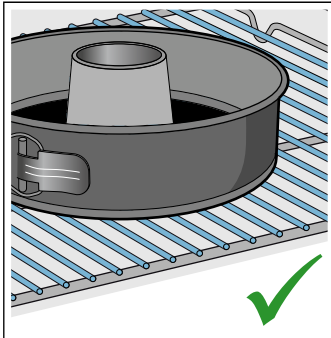
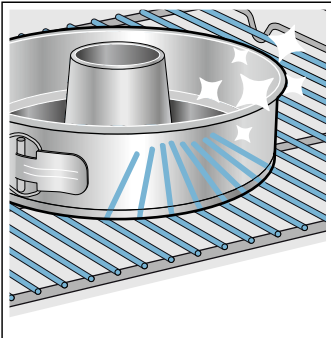

- Remove any unnecessary accessories from the cooking compartment.

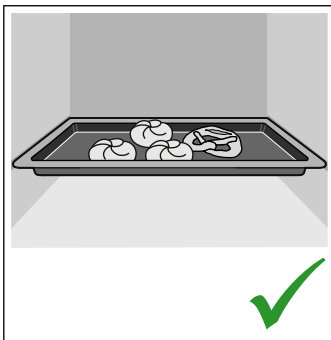
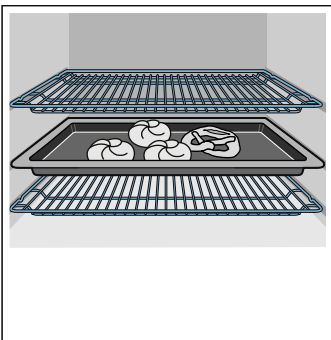

- Open the appliance door as infrequently as possible when the appliance is in use.



- It is best to bake several cakes one after the other. The cooking compartment stays warm. This reduces the baking time for the second cake. You can place two cake tins next to each other in the cooking compartment.



- For longer cooking times, you can switch the appliance off 10 minutes before the end of the cooking time and use the residual heat to finish cooking.

Environmentally-friendly disposal

Dispose of packaging in an environmentally-friendly manner.



This appliance is labelled in accordance with European Directive 2012/19/EU concerning used electrical and electronic appliances (waste electrical and electronic equipment - WEEE). The guideline determines the framework for the return and recycling of used appliances as applicable throughout the EU.

Getting to know your appliance

In this chapter, we will explain the indicators and controls. You will also find out about the various functions of your appliance.

Note: Depending on the appliance model, individual details and colours may differ.

Control panel

In the control panel, you can use the various buttons, touch fields and the rotary selector to set the required function of the appliance. The current settings are shown in the display.

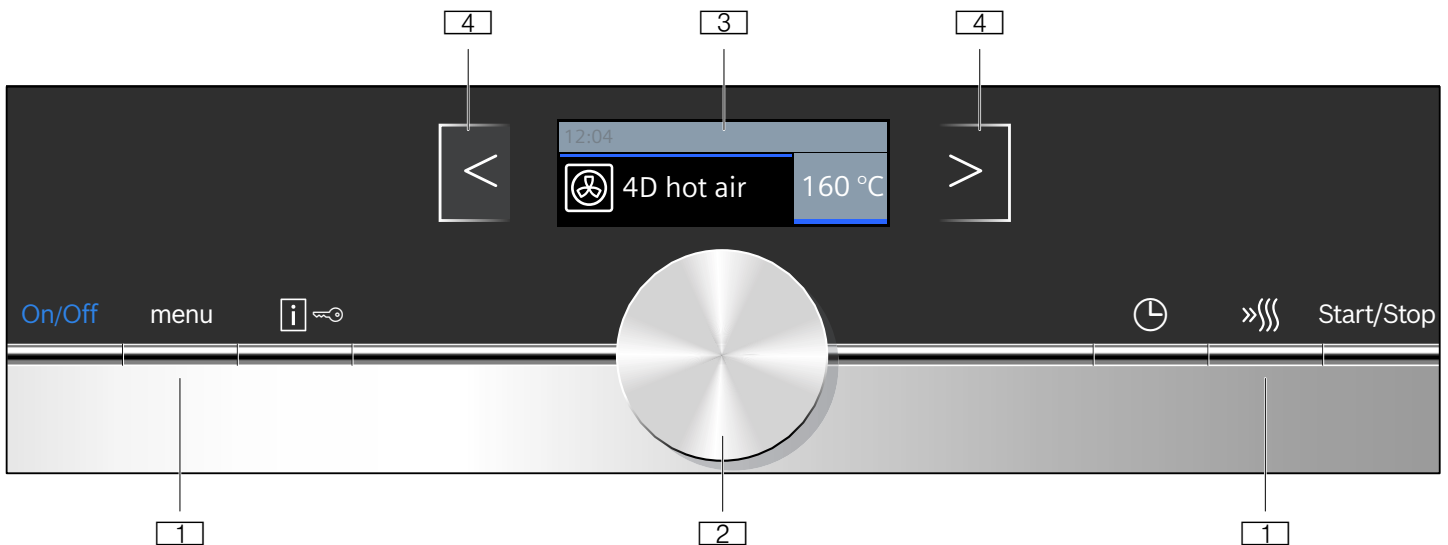

- 1 Buttons**
The buttons to the left and right of the rotary selector have a pressure point. Press these buttons to activate them.
- 2 Rotary selector**
You can turn the rotary selector clockwise and anti-clockwise.
- 3 Display**
You can see the current adjustment values, options or notes in the display.
- 4 Touch fields**
There are sensors under the touch fields to the left < and right > of the display. Touch the respective arrow to select the function.

»»»»	Rapid heat up	Switches rapid heat up on and off
Start/Stop		Starts, pauses or cancels operation
Touch fields		
<	Field to the left of the display	Navigates left
>	Field to the right of the display	Navigates right

Controls

The individual controls are adapted for the various functions of your appliance. You can set your appliance simply and directly.

Buttons and touch fields

Here you can find a short explanation of the various buttons and touch fields.

Buttons		Meaning
on/off		Switches the appliance on and off
menu	Menu	Opens the operating modes menu
i	Information Childproof lock	Displays notes Activates/deactivates the childproof lock
⌚	Time-setting options	Opens the time-setting options menu

Rotary selector

Use the rotary selector to change the operating modes and adjustment values shown in the display.

In most selection lists, e.g. types of heating, the first selection follows the last. For temperature for example, you must turn the rotary selector back when the minimum or maximum temperature is reached.

Display

The display is structured so that the information can be read at a glance.

The value that you can currently set is in focus. It is displayed in white lettering with a dark background.

Status bar

The status bar is at the top of the display. The time and set time functions are displayed here.

Progress line

The progress line is under the status bar. The progress line shows you how much time has elapsed, for example. The line over the in-focus value progresses from left to right, the longer the operation continues to run.

Lapse of time

If you have started your appliance without a cooking time, you can see how long the operation has already been running for at the top on the right in the status bar.







Temperature check

The temperature indicator bars show the heating phases in the cooking compartment.

Heating indicator	The heating indicator displays the rising temperature in the cooking compartment. When all bars are complete, the optimum time for placing the dish in the oven has been reached. The bars do not appear when settings are applied for grilling and cleaning.
Residual heat indicator	When the appliance is switched off, a line appears under the status bar which shows how much residual heat is in the cooking compartment. Once the temperature has dropped to approximately 60 °C, the display goes out.

Types of heating

In order for you to find the correct type of heating for your dish, we have explained the differences and scopes of application here.

Types of heating	Temperature	Use
 4D hot air	30-275 °C	For baking and roasting on one or more levels. The fan distributes the heat from the ring heating element in the back panel evenly around the cooking compartment.
 Top/bottom heating	30-300 °C	For traditional baking and roasting on one level. Especially suitable for cakes with moist toppings. Heat is emitted evenly from above and below.
 Hot air eco	30-275 °C	For gently cooking selected types of food on one level without preheating. The fan distributes the heat from the ring-shaped heating element in the back panel around the cooking compartment. This heating function is most effective between 125 and 275 °C. This heating function is used to measure both the energy consumption in air recirculation mode and the energy efficiency class.
 Top/bottom heating eco	30-300 °C	For gently cooking selected types of food on one level. Heat is emitted from above and below. This heating function is most effective between 150 and 250 °C. This heating function is used to measure the energy consumption in the conventional mode.
 Hot air grilling	30-300 °C	For roasting poultry, whole fish and larger pieces of meat. The grill heating element and the fan switch on and off alternately. The fan circulates the hot air around the food.
 Grill, large area	Grill settings: 1 = low 2 = medium 3 = high	For grilling flat items such as steaks, sausages or bread, and for browning food. The whole area of the grill heating element becomes hot.





Note: Due to thermal inertia, the temperature displayed may be slightly different to the actual temperature inside the oven. You can use the  button to check the current heating temperature when heating up.

Operating modes menu

The menu is divided into different operating modes. In this way, you can quickly access the required function.

Operating mode	Use
Types of heating	There are several finely tuned types of heating for you to prepare your dishes.
Dishes → "Dishes" on page 24	Here you can find preprogrammed setting values which are suitable for many dishes.
Self-cleaning → "Cleaning function" on page 17	The self-cleaning function cleans your oven automatically.
Settings → "Basic settings" on page 16	You can adapt your appliance's basic settings to suit your needs.

When cooking at very high temperatures, the appliance lowers the temperature slightly after an extended period.

	Grill, small area	Grill settings: 1 = low 2 = medium 3 = high	For grilling small quantities of food such as steaks, sausages or bread, and for browning food. The centre part under the grill heating element becomes hot.
	Pizza setting	30-275 °C	For preparing pizza and dishes which require a lot of heat from underneath. The bottom heating element and the ring heating element in the back panel heat up.
	Bottom heating	30-250 °C	For cooking in a bain marie and for the final baking stage. The heat is emitted from below.
	CoolStart function	30-275 °C	For the quick preparation of frozen products on level 3. The temperature depends on the manufacturer's instructions. Use the highest temperature specified on the packaging. The cooking time is as specified or shorter. Preheating is not required.

Default values

For each type of heating, the appliance specifies a default temperature or level. You can accept this value or change it in the appropriate area.

Further information

In most cases, the appliance provides notes and further information on the action just carried out. To do this, press the  button. The note is shown for a few seconds.

Some notes are displayed automatically, for example as confirmation, or to provide an instruction or warning.

Cooking compartment functions

Some functions make your appliance easier to use. This, for example, enables the cooking compartment to be well lit and a cooling fan to prevent the appliance from overheating.

Opening the appliance door

If you open the appliance door during an operation, the operation is paused. Operation continues to run when you close the door.

Interior lighting

When you open the appliance door, the interior lighting switches on. If the door remains open for longer than 15 minutes, the lighting switches off again.

For most operating modes, the interior lighting switches on as soon as the operation is started. When the operation has finished, the lighting switches off.

Note: You can set the interior lighting not to come on during the operation in the basic settings.

Cooling fan

The cooling fan switches on and off as required. The hot air escapes above the door.

Caution!

Do not cover the ventilation slots. Otherwise the oven will overheat.

So that the cooking compartment cools down more quickly after operation, the cooling fan continues to run for a certain period afterwards.

Note: You can change how long the cooling fan continues to run for in the basic settings. → "Basic settings" on page 16

Accessories

Your appliance is accompanied by a range of accessories. Here, you can find an overview of the accessories included and information on how to use them correctly.

Accessories included

Your appliance is equipped with the following accessories:

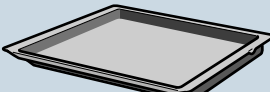
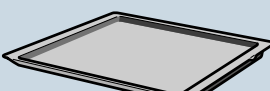
	Wire rack For ovenware, cake tins and ovenproof dishes. For roasts, grilled items and frozen meals.
	Universal pan For moist cakes, pastries, frozen meals and large roasts. It can be used to catch dripping fat when you are grilling directly on the wire rack.
	Baking tray For tray bakes and small baked products.

Only use original accessories. They are specially adapted for your appliance.

You can buy accessories from the after-sales service, from specialist retailers or online.

Note: The accessories may deform when they become hot. This does not affect their function. Once they have cooled down again, they regain their original shape.

Inserting accessories

The cooking compartment has five shelf positions. The shelf positions are counted from the bottom up.

In some appliances, the highest shelf position is marked on the cooking compartment with the grill symbol.

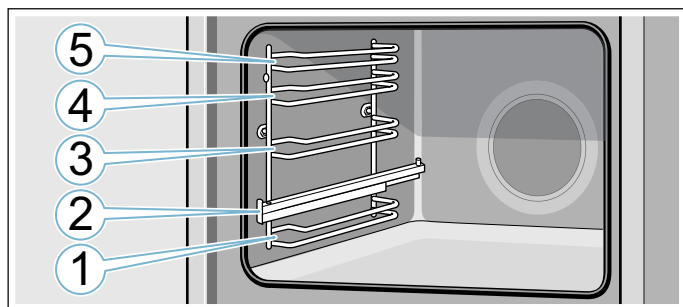

When using shelf positions 1, 3, 4 and 5, always insert the accessory between the two guide bars for a shelf position.

Accessories can be pulled out approximately halfway without tipping. With the pull-out rails at level 2, you can pull the accessories out further.

Make sure that the accessory is placed behind the lug **a** on the pull-out rail.

Example in the picture: Universal pan

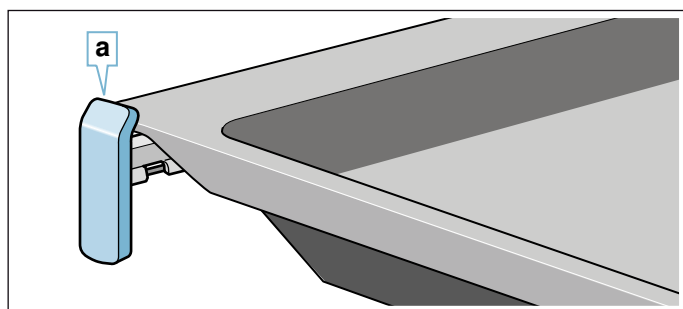

The pull-out rails lock in place when they are fully pulled out. This makes it easy to place the accessories in position. To unlock, push the pull-out rails back into the cooking compartment with a certain amount of force.

Notes

- Make sure that you always insert the accessories into the cooking compartment the right way round.
- Always insert accessories fully into the cooking compartment so that they do not touch the appliance door.

Locking function

The accessories can be pulled out approximately halfway until they lock in place. The locking function prevents the accessories from tilting when they are pulled out. The accessories must be inserted into the cooking compartment correctly for the tilt protection to work properly.

When inserting the wire rack, ensure that lug **a** is at the rear and is facing downwards. The open side must be facing the appliance door and the outer rail must be facing downwards.

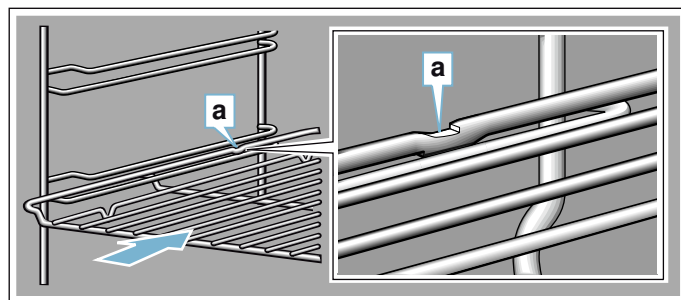

When inserting baking trays, ensure that lug **a** is at the rear and is facing downwards. The sloping edge of the accessory **b** must be facing towards the appliance door.

Example in the picture: Universal pan

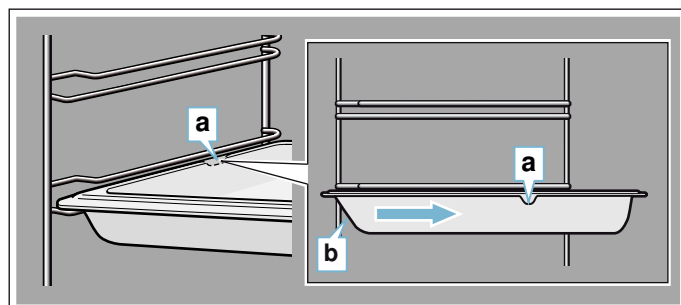

Combining accessories

You can insert the wire rack and the universal pan at the same time to catch drops of liquid.

When inserting the wire rack, ensure that both spacers **a** are at the rear edge. When inserting the universal pan, the wire rack is on top of the upper guide rod of the shelf position.

Example in the picture: Universal pan

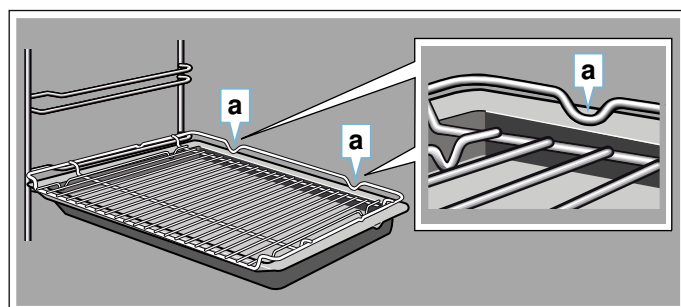

Optional accessories

You can buy optional accessories from the after-sales service, from specialist retailers or online. *You will find a comprehensive range of products for your appliance in our brochures and online.

Both availability and whether it is possible to order online differ between countries. Please see your sales brochures for more details.

Note: Not all optional accessories are suitable for every appliance. When purchasing, please always quote the exact identification number (E-no.) of your appliance.
→ "Customer service" on page 24

Optional accessories	
Wire rack	For ovenware, cake tins and ovenproof dishes, and for roasts and grilled food.
Universal pan, Self-cleaning	For moist cakes, pastries, frozen meals and large roasts. It can be used to catch dripping fat when you are grilling directly on the wire rack.
Baking tray, Self-cleaning	For tray bakes and small baked products.
Wire insert	For meat, poultry and fish. For inserting into the universal pan to catch dripping fat and meat juices.
Profi pan	For preparing large quantities.
Lid for the Profi pan	The lid turns the Profi pan into a Profi roasting dish.
Pizza tray	For pizzas and large round cakes.
Grill tray, Self-cleaning	Use for grilling in place of the wire rack or as a splatter guard. Only use in the universal pan.
Bread-baking stone, Self-cleaning	For home-made bread, bread rolls and pizzas that require a crispy base. The baking stone must be preheated to the recommended temperature.
Glass roasting dish	For stews and bakes. Particularly suitable for the "Meals" operating mode.
Glass tray	For large roasts, moist cakes and bakes.
Glass tray	For bakes, vegetable dishes and baked goods.
Pull-out system, 1 level, Self-cleaning	The pull-out rails at level 2 allow you to pull the accessories out further without them tipping.
Pull-out system, 2 levels, Self-cleaning	The pull-out rails at levels 2 and 3 allow you to pull the accessories out further without them tipping.
Pull-out system, 3 levels, Self-cleaning	The pull-out rails at levels 1, 2 and 3 allow you to pull the accessories out further without them tipping.
Decorative trims	For concealing the lower shelf of the unit and the base of the appliance.

Before using for the first time

Before you can use your new appliance, you must make some settings. You must also clean the cooking compartment and accessories.

Initial use

After connecting the appliance to the power or following a power cut, the settings for initial use are shown in the display.

Note: You can change these settings at any time in the basic settings. → "Basic settings" on page 16

Setting the language

"German" is the preset language.

1. Use the rotary selector to select the required language.
2. Touch the > arrow. The next setting appears.

Setting the time

The time starts at "12:00".

1. Turn the rotary selector to set the current time.
2. Touch the > arrow

Setting the date

The default date is "01.01.2014".

1. Use the rotary selector to set the current day, month and year.
2. Touch the > arrow to confirm. A note appears in the display confirming that the initial use has been completed.

Cleaning the cooking compartment and accessories

Before using the appliance to prepare food for the first time, you must clean the cooking compartment and accessories.

Cleaning the cooking compartment

To remove the new-appliance smell, heat up the cooking compartment when empty and with the oven door closed.

Make sure that there is no leftover packaging, such as polystyrene pellets, in the cooking compartment and remove the adhesive tape that is in or on the appliance. Before heating the appliance, wipe the smooth surfaces in the cooking compartment with a soft, wet cloth. Keep the kitchen ventilated while the appliance is heating.

Apply the settings indicated.

Settings

Type of heating 4D Hotair 

Settings	
Temperature	maximum
Cooking time	1 hour

You can find out how to set the type of heating and the temperature in the next section.

Switch off the appliance after the cooking time indicated using the On/Off button.

After the cooking compartment has cooled down, clean the smooth surfaces with soapy water and a dish cloth.

Cleaning the accessories

Clean the accessories thoroughly using soapy water and a dish cloth or soft brush.

Operating the appliance

You have already learnt about the controls and how they work. Now we will explain how to set your appliance. You will learn about what happens when you switch the appliance on and off, and how to select the operating mode.

Switching the appliance on and off

Before you are able to set the appliance, you must switch it on.

Exception: The childproof lock and the timer can be set when the appliance is switched off.

Displays or information, e.g the residual heat indicator in the cooking compartment, remain visible in the display after the appliance has been switched off.

Switch off your appliance when you do not need to use it. If no settings are applied for a long time, the appliance switches itself off automatically.

Switching the appliance on

Use the On/Off button to switch the appliance on. The on/off symbol above the button is illuminated in blue.

The Siemens logo appears in the display, and then a type of heating and a temperature.

Note: You can specify which operating modes should appear after the appliance is switched on in the basic settings.

Switching off the appliance

Use the On/Off button to switch off the appliance. The lighting above the button goes out.

A set function is cancelled.

The time appears in the display.

Note: You can set whether or not the time should be displayed when the appliance is switched off in the basic settings.

Starting or interrupting operation

To start operation or to interrupt an operation which has started running, press the Start/Stop button. The cooling fan may continue to run after an operation is interrupted.

Press the On/Off button to delete all settings.

If you open the cooking compartment door during operation, operation is interrupted. Close the cooking compartment door to continue operation.

Selecting an operating mode

If you want to set an operating mode, the appliance must be switched on.

1. Press the menu button.
The operating modes menu opens.
2. Use the rotary selector to select the required operating mode.
Depending on the operating mode, different options are available.
3. Use the > arrow to reach the required operating mode.
4. Use the rotary selector to change the selection.
Depending on the option, change different settings.
5. Press the Start/Stop button to start.

Setting the type of heating and temperature

After the appliance is switched on, the suggested type of heating appears with the temperature. You can start this setting immediately with the Start/Stop button.

For other settings, you can change the values as shown in the pictures.

Example: Top/bottom heating, 180 °C

1. Use the rotary selector to change the type of heating.

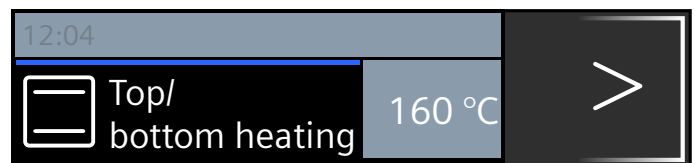

2. Press the arrow > to switch to the temperature.
3. Use the rotary selector to change the temperature.

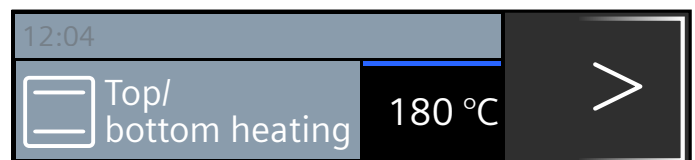

4. Press the Start/Stop button.

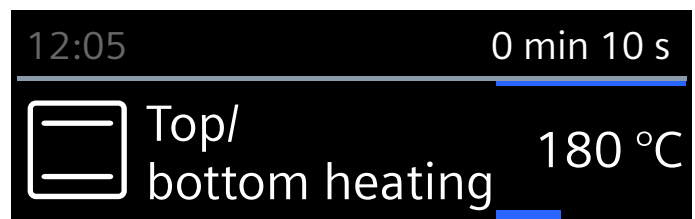



The set type of heating and the temperature are displayed in the display.

Rapid heat up

You can use the »|»| button to heat up the cooking compartment particularly quickly. The rapid heat up function is not possible for all types of heating.

Suitable types of heating:

	4D hot air
	Top/bottom heating

To ensure an even cooking result, do not place your food and the accessory in the cooking compartment until rapid heating is complete.

Making settings

Ensure you have selected a suitable type of heating. The temperature must be set to above 100 °C, otherwise the rapid heat up function cannot be started.

1. Set the type of heating and temperature.
2. Press the »|»| button.

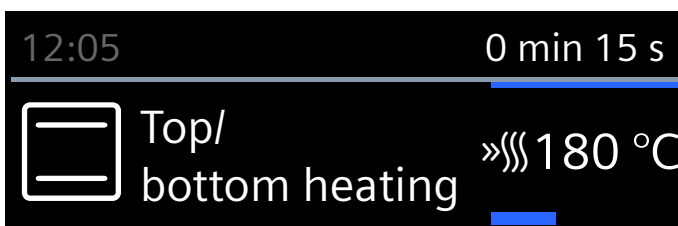

The »|»| symbol appears on the left next to the temperature. The progress line begins to move across.

When rapid heat up is complete, a signal sounds. The »|»| symbol goes out. Place your dish in the cooking compartment.

Notes



- If a cooking time has been set, this runs independently of the rapid heat up process and counts down immediately when operation is started.
- You can use the  button to check the current cooking compartment temperature during rapid heat up.

Cancelling

Press the »|»| button. The »|»| symbol disappears from the display.

Time-setting options

Your appliance has different time-setting options.

Time-setting option	Use
 Timer	The timer functions like an egg timer. An audible signal sounds once the set time has elapsed.
 Cooking time	A signal sounds once a set cooking time has elapsed. The appliance switches off automatically.
 End	Set a cooking time and an end time. The appliance switches on automatically so that the operation ends at the desired time.

Notes

- A cooking time of up to one hour can be set exactly to the minute. A cooking time of over one hour can be set in 5-minute increments.
- Depending on which direction you turn the rotary selector, the cooking time starts at a default value: Anti-clockwise, 10 minutes, Clockwise, 30 minutes.
- After a time-setting option has elapsed, a signal sounds.
- Using the  button, you can request information during operation, which then appears briefly in the display.

Timer

You can set the timer at any time, even if the appliance is switched off. It runs parallel to the other time settings and has a separate audible signal. In this way, you can tell whether it is the timer or a cooking time which has elapsed.

The maximum setting you can apply is 24 hours.



1. Press the  button. The field for the timer opens.
2. Use the rotary selector to set the timer duration. The timer starts after a few seconds.

The  symbol for the timer and the time counting down are displayed on the left in the status bar.



When the time has elapsed

An audible signal sounds. "Timer elapsed" appears in the display. Use the  button to cancel the audible signal early.

Cancelling the timer duration

Press the  button to open the time-setting options menu and turn the time back. Press the  button to close the menu.

Changing the timer duration

Use the  button to open the time-setting options menu and change the timer time in the next few seconds using the rotary selector. Start the timer with the  button.

Cooking time

If you set the cooking time for your food, operation stops automatically once this time has elapsed. The oven stops heating.

Prerequisite: A type of heating and a temperature have been set.

For example: Setting for 4D hot air, 180 °C, cooking time 45 minutes.

1. Press the  button.
The time-setting options menu opens.

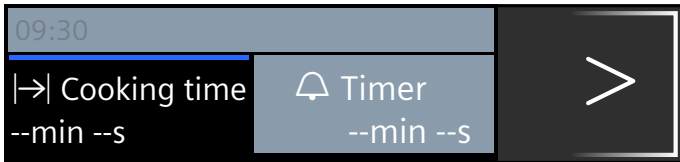

2. Set the cooking time using the rotary selector.

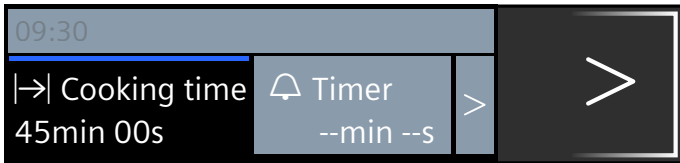

3. Press the Start/Stop button to start.
You can see the cooking time  counting down in the status bar.

The cooking time has elapsed

A signal sounds. The oven stops heating. You can cancel the audible signal early using the  button.

Cancelling the cooking time

Press the  button to open the time-setting options menu. Turn the time back. The type of heating and temperature set are shown in the display.

Changing the cooking time



Press the  button to open the time-setting options menu. Change the cooking time using the rotary selector.

End time

If you change the end time, please remember that easily spoiled foods must not be allowed to remain in the cooking compartment for too long.

Prerequisite: The selected operation has not already begun. A cooking time has been set. The time-setting options menu  is open.

Example in the picture: You put the dish in the cooking compartment at 9:30. It takes 45 minutes to cook and will be ready at 10:15, but you would like it to be ready at 12:45 instead.

1. Touch the  arrow to continue to " End".
2. Set the end time using the rotary selector.

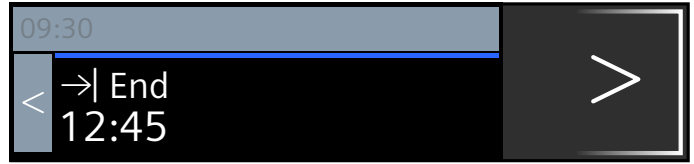

3. Confirm with the Start/Stop button.

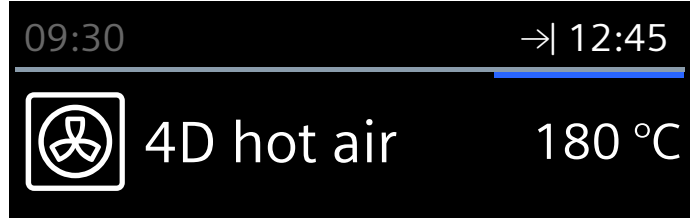





The oven is in standby. The  symbol and the time at which the operation will be finished appear in the status bar. The operation starts at the appropriate time. You can see the cooking time counting down in the status bar.

The cooking time has elapsed

A signal sounds. The oven stops heating. You can cancel the audible signal early using the  button.





Correcting the end time

This is possible if the oven is in standby.

1. Press the Start/Stop button.
2. Press the  button.
The Time-setting Options menu opens.
3. Use the  arrow to switch to " End" and correct the end time using the rotary selector.
4. Press the  button.
5. Press the Start/Stop button.
The oven is on standby.

Cancelling the end time

This is possible if the oven is in standby.



1. Press the Start/Stop button.
2. Press the  button.
The Time-setting Options menu opens.
3. Use the  arrow to switch to " End" and turn the end time back using the rotary selector.
4. Press the  button.
5. Press the Start/Stop button to start.
The cooking time starts to count down immediately.

Childproof lock

Your appliance is equipped with a childproof lock so that children cannot switch it on accidentally or change any settings.

Activating and deactivating

You can activate and deactivate the childproof lock when the appliance is switched on or off.

In each case, press the  button for approx. 4 seconds. A confirmation note appears in the display and the  symbol appears in the status bar.

The appliance door is locked



In the basic settings, you can change the settings so that the appliance door is also locked in addition to the control panel.

The appliance door locks if the temperature in the cooking compartment reaches approx. 50 °C. The  symbol is displayed in the status bar. When the oven is switched off, the appliance door locks immediately if the childproof lock has been activated.

Basic settings

There are various settings available to you in order to help use your appliance effectively and simply. You can change these settings as required.

Changing settings

1. Press the "On/off" button.
2. Press the menu button.
The operating modes menu opens.
3. Use the rotary selector to select "Settings".
4. Touch the arrow .
5. Use the rotary selector to change the values.
6. Use the arrow  to change to the next settings, and change them if necessary.
7. Press the menu button to save.
"Save" or "Discard" appears on the display.

List of settings

This list tells you all the basic settings and how to change them. Depending on the model of the appliance you own, the display will show only those settings that apply to your appliance.

You can change the following settings:

Setting	Options
Select language	Additional languages possible
Time of day	Sets the current time
Date	Sets the current date

Audible signal duration	Short (30 s)
	Medium (1 m)
	Long (5 m)
Button tone	Switched off (button tone still sounds when switching on/off using the "On/off" button)
	Switched on
Display brightness	Can be adjusted to one of five different levels
Clock display	Digital
	Off
Lighting	On during operation
	Off during operation
Childproof lock	Door lock + button lock
	Button lock only
Operation after switching on	Main menu
	Heating modes
	Dishes*
Night-time dimming	Switched off
	Switched on (display dimmed between 10 p.m. and 5.59 a.m.)
Brand name logo	Display
	Do not display
Fan run-on time	Recommended
	Minimum
Pull-out system	Not retrofitted
	Retrofitted
Sabbath mode	Switched on
	Switched off
Factory settings	Restore
	Do not restore

*) Included, depending on appliance model

Caution!

For shelves and single rails: "Not retrofitted" setting.
For sets of two or three rails: "Retrofitted" setting.

Note: Changes to the language, button tone and display brightness settings take effect immediately. All other changes take effect after the settings have been saved.

Changing the time

You can change the time in the basic settings.

For example: Changing from summer to winter time.

1. Press the On/Off button.
2. Press the Menu button.
3. Use the rotary selector to select "Settings".
4. Touch the arrow  to move to "Time of day".
5. Use the rotary selector to change the time.
6. Press the Menu button.
Save or Discard appears in the display.

Power cut

Following a long power cut, the settings for initial use are shown in the display.

Reset the language, time and date.

Sabbath mode

With the Sabbath mode, a cooking time of up to 74 hours can be set. You can keep the food in the cooking compartment warm without having to switch the oven on or off.

Starting Sabbath mode

Prerequisite: "Sabbath mode activated" is activated in the basic settings. → *"Basic settings" on page 16*

The cooking compartment heats with top/bottom heating and a temperature between 85 °C and 140 °C.

1. Press the on/off button.
A type of heating and a temperature are suggested in the display.
2. Turn the rotary selector anti-clockwise and select the "Sabbath mode" type of heating.
3. Tap the > arrow and set the temperature using the rotary selector.
4. Press the ⌚ button to open the time-setting options menu.
25:00 hours are suggested.
5. Use the rotary selector to set the required cooking time.
6. Press the start/stop button to start.
You can see the cooking time counting down in the status bar.

The cooking time has elapsed

A signal sounds. The oven stops heating.

Setting a later end time

It is not possible to set a later end time.

Cancelling Sabbath mode

Press the On/Off button. All settings are deleted. You can apply new settings.

Cleaning function

Use "Self-cleaning" mode to clean the cooking compartment.

You can choose from three cleaning settings.

Setting	Cleaning level	Duration
1	Light	Approx. 1 hour, 15 minutes
2	Medium	Approx. 1 hour, 30 minutes
3	Intensive	Approx. 2 hours

The dirtier the cooking compartment and the longer the dirt has been there, the higher the cleaning setting should be. A cleaning cycle requires only approx. 2.5 – 4.7 kilowatt hours.

Note: For your safety, the cooking compartment door locks automatically. It cannot be opened again until the  symbol for the locking mechanism goes out in the status bar. The interior lighting remains off during cleaning.

Warning Risk of burns!

- The cooking compartment becomes extremely hot during the cleaning function. Never open the appliance door. Allow the appliance to cool down. Keep children away from the appliance.
-  The appliance will become very hot on the outside during the cleaning function. Never touch the appliance door. Allow the appliance to cool down. Keep children away from the appliance.

Warning Risk of harm to health!

The cleaning function heats up the cooking compartment to a very high temperature so that food remnants left over from roasting, grilling and baking will burn off. This process releases vapours, which can irritate the mucous membranes. While the cleaning function is running, keep the kitchen well ventilated. Do not remain in the room for long periods. Keep children and pets away. Follow the instructions even when using the Delayed start function with a delayed end time.

Prior to initiating the cleaning function

While cleaning is in progress, you can clean an accessory at the same time, e.g. the universal pan or the baking tray. Before cleaning is started, remove the worst dirt. Slide the accessory in at level 2.

Clean the inside of the appliance door and along the surface edges of the cooking compartment in the area around the seal. Do not scrub the seal and do not remove!

Note: When using the cleaning function, you can clean the enamel accessory provided at the same time. You cannot clean any of the wire racks when using the cleaning function. The wire racks are not suitable for cleaning using the cleaning function; this will discolour them. Further accessories suitable for cleaning using

the cleaning function are listed in the table for special accessories. → "Accessories" on page 10

Warning **Risk of fire!**

- Loose food residues, grease and meat juices may catch fire during the cleaning function. Before starting the cleaning function, remove coarse dirt from the cooking compartment and from the accessories.
- The appliance will become very hot on the outside during the cleaning function. Never hang combustible objects, e.g. tea towels, on the door handle. Do not place anything against the front of the appliance. Keep children away from the appliance.

Warning – Risk of serious damage to health!

The appliance will become very hot during the cleaning function. The non-stick coating on baking trays and tins is destroyed and noxious gases are released. Never clean non-stick baking trays and baking tins using the cleaning function. Only clean enamelled accessories using the cleaning function.

Setting the self-cleaning function

1. Press the menu button.
The operating modes menu opens.
2. Use the rotary selector to select "Self cleaning".
3. Touch the arrow >.
Cleaning setting 3 is suggested. You can start the cleaning process immediately using the "Start/stop" button or
4. select a different cleaning setting using the rotary selector.
5. Press the "Start/stop" button.
Instructions for the cleaning operation appear on the display.
6. Press the "Start/stop" button to start the cleaning operation.

Ventilate the kitchen when the cleaning function is running.

The cooking compartment door locks shortly after operation starts. The  symbol for the locking mechanism appears on the right-hand side of the status bar next to the elapsing duration.

The cooking compartment door cannot be opened until the  symbol goes out in the status bar.

Once the cleaning has finished

An audible signal sounds. The oven stops heating. Use the  button to switch off the audible signal. "Appliance cooling down" appears on the display.

Cancelling the cleaning operation

Use the "On/off" button to switch off the oven. The cooking compartment door cannot be opened until the  symbol goes out in the status bar.

Adjusting the cleaning setting

Once cleaning starts, the cleaning setting can no longer be changed.

You can set the cleaning to run overnight

In the section "Time settings", you can find out how to delay the end time. This allows you to use the oven at any time throughout the day. → "Time-setting options" on page 14

Once the cleaning function has ended

Once the cooking compartment has cooled down, use a damp cloth to wipe off the ash that has been left behind in the cooking compartment, in the accessories on the racks and around the appliance door.

Wipe the pull-out rails with a damp cloth. Then slide the pull-out rails in and out several times. After cleaning, some discolouration may remain on the pull-out rails. This has no effect on performance.

Note: Very bad soiling may cause white deposits to remain on the enamel surfaces. This is residue from the food and is harmless. It does not affect performance. You can remove these residues using lemon juice if required.

Cleaning

With good care and cleaning, your appliance will retain its appearance and remain fully functioning for a long time to come. We will explain here how you should correctly care for and clean your appliance.

Suitable cleaning agents

To ensure that the different surfaces are not damaged by using the wrong cleaning agent, observe the information in the table. Depending on the appliance model, not all of the areas listed may be on/in your appliance.

Caution!

Risk of surface damage

Do not use:

- Harsh or abrasive cleaning agents,
- Cleaning agents with a high alcohol content,
- Hard scouring pads or cleaning sponges,
- High-pressure cleaners or steam cleaners,
- Special cleaners for cleaning the appliance while it is hot.

Wash new sponge cloths thoroughly before use.

Tip: Highly recommended cleaning and care products can be purchased through the after-sales service. Observe the respective manufacturer's instructions.

Warning – Risk of burns!

The appliance becomes very hot. Never touch the interior surfaces of the cooking compartment or the heating elements. Always allow the appliance to cool down. Keep children at a safe distance.

Area	Cleaning
Appliance exterior	
Stainless steel front	<p>Hot soapy water: Clean with a dish cloth and then dry with a soft cloth.</p> <p>Remove flecks of limescale, grease, starch and albumin (e.g. egg white) immediately. Corrosion can form under such flecks.</p> <p>Special stainless steel cleaning products suitable for hot surfaces are available from our after-sales service or from specialist retailers. Apply a very thin layer of the cleaning product with a soft cloth.</p>
Plastic	<p>Hot soapy water: Clean with a dish cloth and then dry with a soft cloth.</p> <p>Do not use glass cleaner or a glass scraper.</p>
Painted surfaces	<p>Hot soapy water: Clean with a dish cloth and then dry with a soft cloth.</p>
Control panel	<p>Hot soapy water: Clean with a dish cloth and then dry with a soft cloth.</p> <p>Do not use glass cleaner or a glass scraper.</p>
Door panels	<p>Hot soapy water: Clean with a dish cloth and then dry with a soft cloth.</p> <p>Do not use a glass scraper or a stainless steel scouring pad.</p>
Door handle	<p>Hot soapy water: Clean with a dish cloth and then dry with a soft cloth.</p> <p>If descaler comes into contact with the door handle, wipe it off immediately. Otherwise, any stains will not be able to be removed.</p>
Appliance interior	
Enamelled surfaces	<p>Hot soapy water or a vinegar solution: Clean with a dish cloth and then dry with a soft cloth.</p> <p>Soften baked-on food remnants with a damp cloth and soapy water. Use stainless steel wire wool or oven cleaner to remove stubborn dirt.</p> <p>Caution! Never use oven cleaner in the cooking compartment when it is still warm. This may damage the enamel. Remove all food remnants from the cooking compartment and the appliance door before you next heat up the appliance.</p> <p>Leave the cooking compartment open to dry after cleaning it.</p> <p>It is best to use the cleaning function. → "Cleaning function" on page 17</p> <p>Note: Food residues can cause white deposits to form. These are harmless and do not affect how the appliance works. Remove using lemon juice if required.</p>

Glass cover for the interior lighting	<p>Hot soapy water: Clean with a dish cloth and then dry with a soft cloth.</p> <p>If the cooking compartment is heavily soiled, use oven cleaner.</p>
Door cover	<p>made from stainless steel: Use stainless steel cleaner. Follow the manufacturers' instructions. Do not use stainless steel care products.</p> <p>made from plastic: Clean using hot soapy water and a dish cloth. Dry with a soft cloth. Do not use glass cleaner or a glass scraper.</p> <p>Remove the door cover for cleaning.</p>
Rails	<p>Hot soapy water: Soak and clean with a dish cloth or brush.</p>
Pull-out system	<p>Hot soapy water: Clean with a dish cloth or a brush.</p> <p>Do not remove the lubricant while the pull-out rails are pulled out – it is best to clean them when they are pushed in. Do not clean in the dishwasher.</p>
Accessories	<p>Hot soapy water: Soak and clean with a dish cloth or brush.</p> <p>If there are heavy deposits of dirt, use a stainless steel scouring pad.</p>

Notes

- Slight differences in colour on the front of the appliance are caused by the use of different materials, such as glass, plastic and metal.
- Shadows on the door panels, which look like streaks, are caused by reflections made by the interior lighting.
- Enamel is baked on at very high temperatures. This can cause some slight colour variation. This is normal and does not affect operation. The edges of thin trays cannot be completely enamelled. As a result, these edges can be rough. This does not impair the anti-corrosion protection.

Keeping the appliance clean

Always keep the appliance clean and remove dirt immediately so that stubborn deposits of dirt do not build up.

Warning – Risk of fire!

Loose food remnants, fat and meat juices may catch fire. Before using the appliance, remove the worst of the food remnants from the cooking compartment, heating elements and accessories.

Tips

- Clean the cooking compartment after each use. This will ensure that dirt cannot be baked on.
- Always remove flecks of limescale, grease, starch and albumin (e.g. egg white) immediately.
- Use the universal pan for baking very moist cakes.
- Use suitable ovenware for roasting, e.g. a roasting dish.

Rails

With good care and cleaning, your appliance will retain its appearance and remain fully functional for a long time to come. This will tell you how to remove the shelves and clean them.

Detaching and refitting the rails

Warning – Risk of burns!

The rails become very hot. Never touch the hot rails. Always allow the appliance to cool down. Keep children away from the appliance.

Detaching the rails

1. Lift the rail slightly at the front **a** and detach it **b** (figure **1**).
2. Then pull the whole rail towards you and take it out (figure **2**).

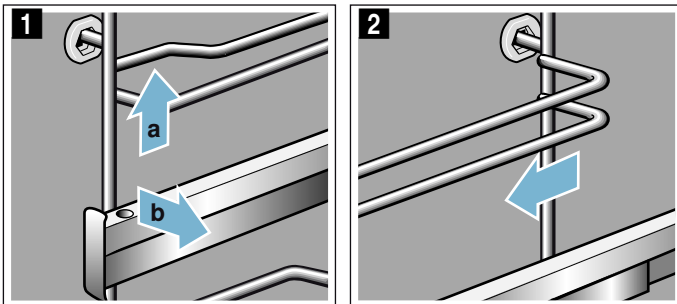

Clean the rails with cleaning agent and a sponge. For stubborn deposits of dirt, use a brush.

Attaching the rails

The rails only fit on the right or the left side. The pull-out rails must pull out towards you.

1. First, insert the rail in the middle of the rear socket **a**, until the rail rests against the cooking compartment wall, and push it back **b** (figure **1**).
2. Then insert the rail into the front socket **c**, until the rail also rests against the cooking compartment wall here, and press it downwards **d** (figure **2**).

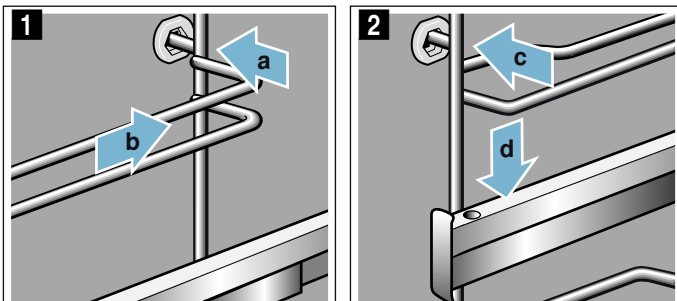

Appliance door

With good care and cleaning, your appliance will retain its appearance and remain fully functional for a long time to come. This will tell you how to remove the appliance door and clean it.

Removing and fitting the appliance door

For cleaning purposes and to remove the door panels, you can detach the appliance door.

The appliance door hinges each have a locking lever. When the locking levers are closed (figure **1**), the appliance door is secured in place. It cannot be detached.

When the locking levers are open in order to detach the appliance door (figure **2**), the hinges are locked. They cannot snap shut.

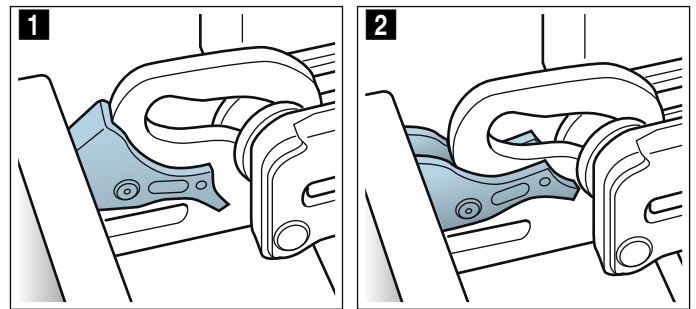

Warning

Risk of injury!

- If the hinges are not locked, they can snap shut with great force. Ensure that the locking levers are always fully closed or, when detaching the appliance door, fully open.
- The hinges on the appliance door move when opening and closing the door, and you may be trapped. Keep your hands away from the hinges.

Removing the appliance door

1. Open the appliance door fully and push it in the direction of the appliance.
2. Fold up the two locking levers on the left and right (figure **1**).
3. Close the appliance door as far as it goes **a**. With both hands, grip the door on the left- and right-hand side and pull it up and out (figure **2**).

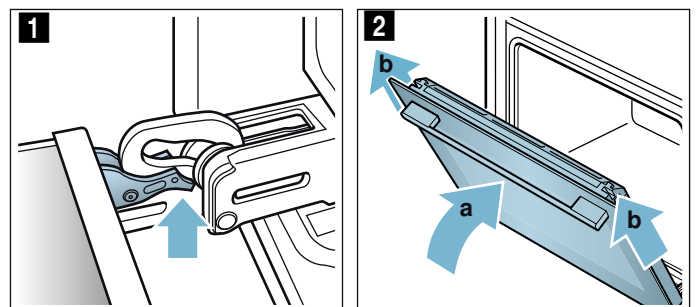

Fitting the appliance door

Reattach the appliance door in the opposite sequence to removal.

1. When attaching the appliance door, ensure that both hinges are inserted straight into the opening (figure 1). Place both hinges at the bottom on the outer panel and use this as a guide. Ensure that the hinges are inserted into the correct opening. You must be able to insert them easily and without resistance. If you can feel any resistance, check that the hinges are inserted into the correct opening.

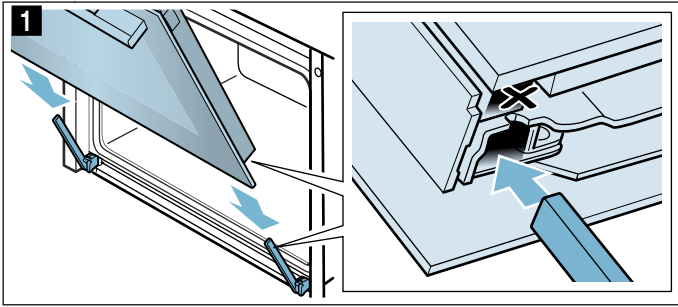

2. Open the appliance door fully. Fold both locking levers closed again (figure 2).

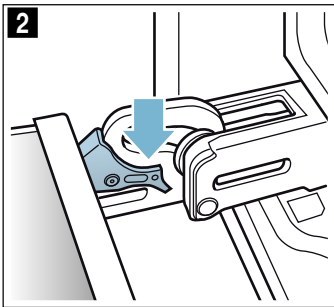

3. Close the cooking compartment door.

Removing the door cover

The stainless steel inlay in the door cover may become discoloured. To carry out thorough cleaning, you can remove the cover. → "Cleaning" on page 18

1. Open the appliance door slightly.
2. Press on the right and left side of the cover (figure 1).
3. Remove the cover (figure 2). Close the appliance door carefully.

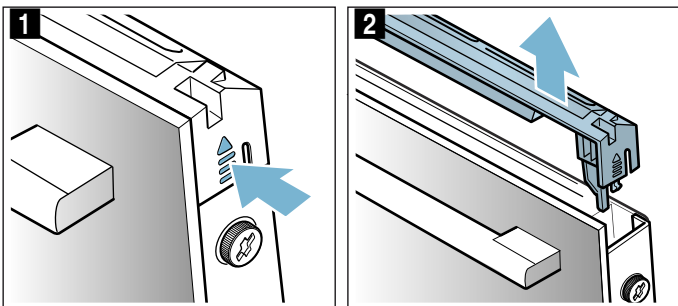

Note: Clean the stainless steel inlay in the cover with stainless steel cleaner. Clean the rest of the door cover with soapy water and a soft cloth.

4. Open the appliance door again slightly. Put the cover back in place and press on it until it clicks audibly into place (figure 3).

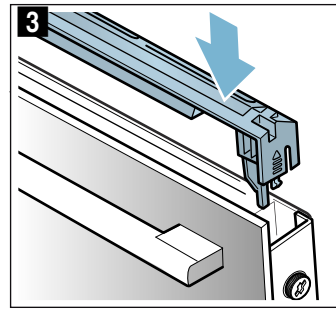

5. Close the appliance door.

Removing and installing the door panels

To facilitate cleaning, you can remove the glass panels from the appliance door.

Removing the door from the appliance

1. Open the appliance door slightly.
2. Press on the right and left side of the cover (figure 1).
3. Remove the cover (figure 2).

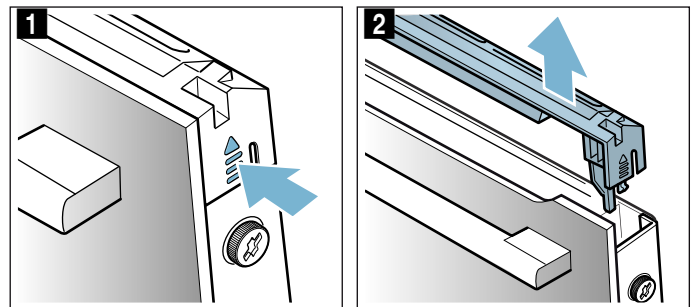

4. Loosen and remove the screws on the left and right of the appliance door (figure 3).
5. Before closing the door again, trap a tea towel which has been folded several times in the door (figure 4). Pull out the front panel upwards and lay it on a flat surface with the door handle facing downwards.

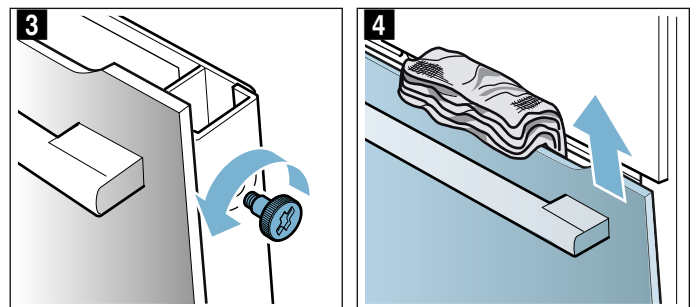

6. Push both retainers on the intermediate panel upwards, but do not remove it (figure 5). Hold the panel with one hand. Remove the panel.

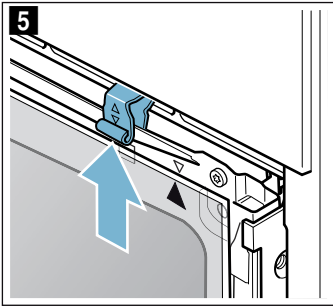

Clean the panels with glass cleaner and a soft cloth.

⚠ Warning
Risk of injury!

- Scratched glass in the appliance door may develop into a crack. Do not use a glass scraper, sharp or abrasive cleaning aids or detergents.
- The hinges on the appliance door move when opening and closing the door, and you may be trapped. Keep your hands away from the hinges.

Fitting the door on the appliance

When fitting the intermediate panel, make sure that the arrow is in the top right of the panel and that it aligns with the arrow on the metal panel.

1. Insert the intermediate panel at the bottom into the retainer and push it in firmly at the top (figure 1).
2. Push both retainers downwards (figure 2).

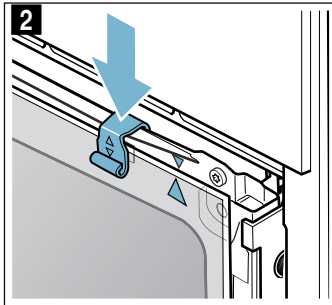
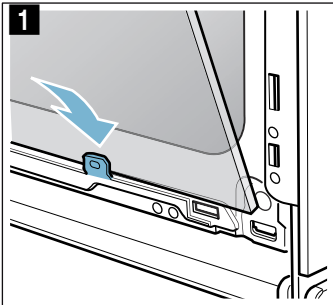

3. Insert the front panel at the bottom into the retainers (figure 3).
4. Close the front panel until both upper hooks are opposite the opening (figure 4).

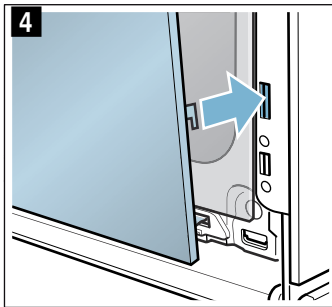
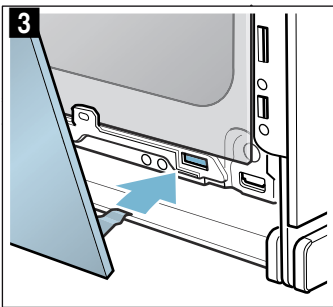

5. Press the front panel at the bottom until it clicks audibly into place (figure 5).
6. Open the appliance door again slightly and remove the tea towel.
7. Screw both screws back in on the left and right.
8. Put the cover back in place and press on it until it clicks audibly into place (figure 6).

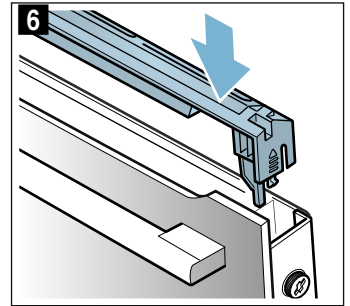
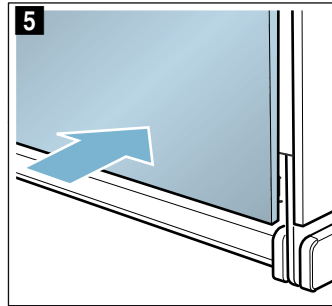

9. Close the appliance door.

Caution!

Do not use the cooking compartment again until the panels have been correctly fitted.





Trouble shooting

If a fault occurs, there is often a simple explanation. Before calling the after-sales service, please refer to the fault table and attempt to correct the fault yourself.

Note: If a dish does not turn out as well as you had hoped, refer to the table section at the end of the instruction manual, where you will find plenty of tips and

Fault table

If an error message beginning with 'E' is shown, e.g. E0111, switch the appliance off and then on again. If

Fault	Possible cause	Information/remedial action
The appliance does not work	The fuse is faulty	Check in the fuse box to make sure that the fuse for the appliance is in working order
	Power cut	Check whether other kitchen appliances are working
The appliance door will not open; the  symbol is shown in the display	The appliance door is locked until the cooking compartment has cooled down.	Wait until the  symbol goes out
Although the appliance is switched on, it cannot be operated; the  symbol is shown in the display	The child lock is activated	Press and hold the  button until the  symbol goes out
The cooking compartment does not heat and "Demo mode on" is shown in the display	The appliance is in demo mode	Switch off the fuse in the fuse box and switch it back on again after approx. 10 seconds. Switch on the appliance and select "Demo mode off" in the settings.
The appliance will not start and "Cooking compartment too hot" appears on the display	The cooking compartment is too hot for the selected dish or type of heating	Allow the cooking compartment to cool down and start again

Maximum operating time exceeded

Your appliance automatically ends the operation if no duration has been set and the setting has not been changed for a long time.

The point at which this occurs depends on the temperature or grill setting that has been set.

A message appears on the display on the appliance to say that the operation is being ended automatically. The operation is then cancelled.

To use the appliance again, first switch it off. To switch the appliance back on again set the required operation.

Tip: Set a cooking time so that the appliance does not switch off when you do not want it to, e.g. with an extremely long preparation time. The appliance heats up until the set cooking time has elapsed.

Replacing the bulb in the top of the cooking compartment

If the cooking compartment light bulb fails, it must be replaced. Heat-resistant, 40 watt, 230 V halogen bulbs are available from the after-sales service or specialist retailers.

When handling the halogen bulb, use a dry cloth. This will increase the service life of the bulb. Only use these bulbs.

information. → "Tested for you in our cooking studio" on page 25

Warning – Risk of electric shock!

Incorrect repairs are dangerous. Repairs may only be carried out and damaged power cables replaced by one of our trained after-sales technicians. If the appliance is defective, unplug the appliance from the mains or switch off the circuit breaker in the fuse box. Contact the after-sales service.

this message appears again, contact the after-sales service.

Warning – Risk of electric shock!

When replacing the cooking compartment bulb, the bulb socket contacts are live. Before replacing the bulb, unplug the appliance from the mains or switch off the circuit breaker in the fuse box.

Warning – Risk of burns!

The appliance becomes very hot. Never touch the interior surfaces of the cooking compartment or the heating elements. Always allow the appliance to cool down. Keep children at a safe distance.

1. Place a tea towel in the cold cooking compartment to prevent damage.
2. Turn the glass cover anti-clockwise to remove it (figure **1**).
3. Pull out the bulb – do not turn it (figure **2**). Insert the new bulb, making sure that the pins are in the correct position. Push the bulb in firmly.

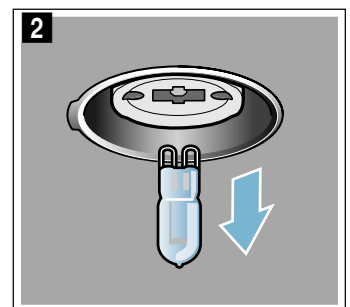
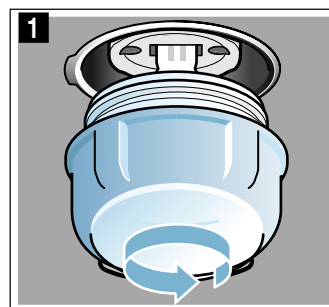

4. Screw the glass cover back on.
Depending on the appliance model, the glass cover may have a sealing ring. If the glass cover has a sealing ring, put it back in place before screwing the cover back on.
5. Remove the tea towel and switch on the circuit breaker.

Glass cover

If the glass cover of the halogen bulb is damaged, it must be replaced. You can obtain a new glass cover from the after-sales service. Please specify the E number and FD number of your appliance.

Customer service

Our after-sales service is there for you if your appliance needs to be repaired. We will always find an appropriate solution, also in order to avoid after-sales personnel having to make unnecessary visits.

E number and FD number

When calling us, please quote the full product number (E no.) and the production number (FD no.) so that we can provide you with the correct advice. The rating plate bearing these numbers can be found when you open the appliance door.

On some appliances with a steam-assisted cooking function, you will find the rating plate behind the control panel.

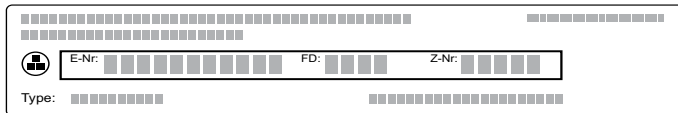

To save time, you can make a note of the numbers for your appliance and the telephone number of the after-sales service in the space below in case you need them.

E no.	FD no.
--------------	---------------

After-sales service

Please note that a visit from an after-sales service engineer is not free of charge in the event that the appliance has been misused, even during the warranty period.

After-sales contact details for all countries can be found in the attached after-sales service directory.

Dishes

You can use the "Dishes" operating mode to prepare a wide variety of food. The appliance selects most settings for you.

To achieve good results, the cooking compartment must not be too hot for the type of food you have selected. If it is, a message will appear on the display. Allow the cooking compartment to cool down and start again.

Information on the setting

- The cooking result depends on the quality of the food and the type of cookware. For an optimal cooking result, use food that is in good condition and chilled meat only.
- The appliance chooses the optimal heating mode and the time and temperature setting for you. You will only be asked to enter the weight. It is not possible to set weights outside of the intended weight range.
- When roasting dishes for which the appliance will apply the temperature selection for you, temperatures of up to 300 °C can be saved. Therefore, make sure that you use cookware that is sufficiently heat resistant.
- Information is provided, e.g. on cookware, shelf position or the addition of liquid when cooking meat. Some food requires turning or stirring, etc., during cooking. This is shown on the display shortly after operation starts. An audible signal will remind you at the right time.
- Information on the right kind of cookware to use and tips and tricks for the preparation can be found at the end of the instruction manual.

Selecting a dish

The following table shows the corresponding setting values for the listed dishes.

Dishes
Chicken, unstuffed
Turkey breast
Pork neck joint, boned
Pot-roasted beef
Joint of veal, marbled
Leg of lamb, boned, medium
Meat loaf made from fresh minced meat
Goulash
Beef olives
Vegetable stew

Applying settings for dishes

You will be guided through the entire setting process for your chosen food. Always touch the > arrow.

1. Press the menu button.
2. Use the rotary selector to select "Dishes".
3. Touch the > arrow.
The first dish will appear, along with a default value for the weight.
4. Use the rotary selector to select the food you require.
5. Touch the > arrow.
6. Turn the rotary selector to set the weight.
7. Touch the > arrow.
Note: Information will be displayed on the best shelf position, cookware, etc. to use.
8. Press the Start/Stop button to start.

You will be guided through the entire setting process for your chosen food. Always touch the > arrow.

The setting has ended

A signal sounds. The oven stops heating. You can cancel the audible signal early using the ⏸ button.

If you are not satisfied with the cooking result, you can increase the cooking time again. Touch the "Extend cooking time" field. A cooking time is suggested. You can change this if you wish.

If you are satisfied with the cooking result, touch "Finish". "Enjoy your meal" appears in the display.

Cancelling the setting

Press the On/Off button. All settings are deleted. You can implement new settings.

Setting a later end time

For some dishes, it is possible to set a later end time. You can find out how to set a later end time by looking in the time-setting options. → *"Time-setting options" on page 14*

Once you have set an end time, the display shows the waiting time. The status bar shows the time at which operation is to end. None of the settings can be changed. Please remember that easily spoiled foods must not be allowed to remain in the cooking compartment for too long.

Tested for you in our cooking studio

Here, you can find a selection of dishes and the ideal settings for them. We will show you which type of heating and temperature are best suited to your dish. You will get information on suitable cooking accessories and the height at which they should be placed in the oven. You will also get tips about cookware and preparation methods.

Note: A lot of steam can build up in the cooking compartment when cooking food. Your appliance is very energy-efficient and radiates very little heat to its surroundings during operation. Due to the high difference in temperature between the appliance interior and the external parts of the appliance, condensation may build up on the door, control panel or adjacent kitchen cabinet panels. This is a normal physical phenomenon. Condensation can be reduced by preheating the oven or opening the door carefully.

Silicone moulds

For the best cooking results, we recommend dark-coloured metal baking tins/dishes.

Nevertheless, if you wish to use silicone moulds, follow the manufacturer's instructions and recipes. Silicone moulds are often smaller than normal baking tins. Quantity and recipe specifications may vary.

Cakes and small baked items

Your appliance offers you a range of heating types for the preparation of cakes and small baked items. You can find the ideal settings for many dishes in the settings tables.

Also refer to the notes in the section on allowing dough to rise.

Only use original accessories supplied with your appliance. These have been tailored to the cooking compartment and the operating modes of your appliance.

Shelf positions

Use the indicated shelf positions.

Baking on one level

When baking on one level, use the following shelf positions:

- Tall baked items: Level 2
- Flat baked items: Level 3

If you are using 4D Hot air as the type of heating, you can choose between levels 1, 2, 3 and 4.

Baking on several levels

Use 4D hot air. Baked items that are placed into the oven on trays or in baking tins/dishes at the same time will not necessarily be ready at the same time.

Baking on two levels:

- Universal pan: Level 3
Baking tray: Level 1
- Baking tins/dishes on the wire rack
First wire rack: Level 3
Second wire rack: Level 1

Baking on three levels:

- Baking tray: Level 5
Universal pan: Level 3
Baking tray: Level 1

Baking on four levels:

- 4 wire racks with greaseproof paper
First wire rack: Level 5
Second wire rack: Level 3
Third wire rack: Level 2
Fourth wire rack: Level 1

By preparing several dishes at the same time, you can make energy savings of up to 45 per cent. Position baking tins/dishes next to one another or offset and vertically stacked in the cooking compartment.

Accessories

Ensure that you always use suitable accessories and that they are placed in the oven the right way around.

Wire rack

Insert the wire rack with the open side facing the appliance door and the curved lip pointing downwards. Always place ovenware, tins and dishes on the wire rack.

Universal pan or baking tray

Slide the universal pan or the baking tray in carefully as far as the limit stop with the bevelled edge facing the appliance door.

When baking moist cakes or pastries with many toppings, use the universal pan so that any excess liquid does not overflow and make the cooking compartment dirty.

Baking tins

Dark- coloured metal baking tins are most suitable.

Tinplate baking tins, ceramic dishes and glass dishes extend baking time and mean that the baked item will not brown evenly. If you wish to bake using these

baking tins/dishes and using top/bottom heating, slide in the tin/dish at level 1.

Greaseproof paper

Only use greaseproof paper that is suitable for the selected temperature. Always cut greaseproof paper to size.

Recommended setting values

The table lists the optimal heating type for various baked items. The temperature and baking time depend on the amount and consistency of the dough/mixture. For this reason, the table specifies setting ranges. Try using the lower values to start with. A lower temperature will result in more even browning. You can use a higher setting next time if necessary.

Note: Baking times cannot be reduced by using higher temperatures. Cakes or small baked items would only be cooked on the outside, and would not be fully baked in the middle.



The setting values apply to food that is placed into a cold cooking compartment; by doing this, you can make energy savings of up to 20 per cent. If you preheat the oven, you can reduce the indicated baking times by several minutes.







Preheating is necessary for selected food, and this is indicated in the table. Do not place your food or accessories into the cooking compartment until it has finished preheating.





































If you wish to follow one of your own recipes when baking, you should use the setting values listed for similar baked items in the table as reference. Additional information can be found in the baking tips listed after the settings table.

Remove unused accessories from the cooking compartment. This will ensure that you achieve the best possible cooking results and energy savings of up to 20 per cent.

Types of heating used:

-  4D hot air
-  Top/bottom heating
-  Pizza setting

Dish	Accessories/cookware	Shelf position	Heating function	Temperature in °C	Cooking time in mins.
Cakes in tins					
Sponge cake, simple	Ring tin/cake tin	2		150-170	50-70
Sponge cake, simple, 2 levels	Ring tin/cake tin	3+1		140-160	60-80
Sponge cake, delicate	Ring tin/cake tin	2		150-170	60-80
Fruit flan made from sponge mixture, delicate	Ring/springform cake tin	2		160-180	40-60
Sponge flan base	Flan base tin	3		160-180	20-30
Fruit tart or cheesecake with shortcrust pastry base	Springform cake tin, Ø 26 cm	2		170-190	60-80
Swiss flan	Pizza tray	3		170-190	45-55
* Preheat					
** Preheat for 5 mins., do not use quick heat function					

Dish	Accessories/cookware	Shelf position	Heating function	Temperature in °C	Cooking time in mins.
Tart	Flan-base cake tin, black	3		190-210	25-40
Bundt yeast cake	Ring cake tin	2		150-170	50-70
Yeast cake	Springform cake tin, Ø 28 cm	2		160-170	20-30
Sponge base, 2 eggs	Flan base tin	3		150-170*	20-30
Sponge flan, 3 eggs	Springform cake tin, Ø 26 cm	2		160-170*	25-35
Sponge flan, 6 eggs	Springform cake tin, Ø 28 cm	2		150-170*	30-50
Cakes on baking trays					
Sponge cake with topping	Baking tray	3		160-180	20-40
Sponge cake, 2 levels	Universal pan + baking tray	3+1		140-160	30-50
Shortcrust tart with dry topping	Baking tray	3		170-190	25-35
Shortcrust tart with dry topping, 2 levels	Universal pan + baking tray	3+1		160-170	35-45
Shortcrust tart with moist topping	Universal pan	3		160-180	55-65
Swiss flan	Universal pan	3		170-190	45-55
Yeast cake with dry topping	Universal pan	3		160-180	15-20
Yeast cake with dry topping, 2 levels	Universal pan + baking tray	3+1		150-170	20-30
Yeast cake with moist topping	Universal pan	3		180-200	30-40
Yeast cake with moist topping, 2 levels	Universal pan + baking tray	3+1		150-170	45-60
Plaited loaf, savarin	Baking tray	2		160-170	25-35
Swiss roll	Baking tray	3		180-200*	8-15
Stollen with 500 g flour	Baking tray	2		150-170	45-60
Strudel, sweet	Universal pan	2		170-180	50-60
Strudel, frozen	Universal pan	3		200-220	35-45
Small baked items					
Small cakes	Baking tray	3		160**	20-30
Small cakes	Baking tray	3		150**	25-35
Small cakes, 2 levels	Universal pan + baking tray	3+1		150**	25-35
Small cakes, 3 levels	Baking trays + universal pan	5+3+1		140**	35-45
Muffins	Muffin tray	3		170-190	15-20
Muffins, 2 levels	Muffin trays	3+1		160-180*	15-30
Small yeast cakes	Baking tray	3		160-180	25-35
Small yeast cakes, 2 levels	Universal pan + baking tray	3+1		150-170	25-40
Puff pastry	Baking tray	3		170-190*	20-35
Puff pastry, 2 levels	Universal pan + baking tray	3+1		170-190*	20-45
Puff pastry, 3 levels	Baking trays + universal pan	5+3+1		170-190*	20-45
Puff pastry, flat, 4 levels	4 wire racks	5+3+2+1		180-200*	20-35
Choux pastry	Baking tray	3		200-220	30-40
Choux pastry, 2 levels	Universal pan + baking tray	3+1		190-210	35-45
Danish pastry	Baking tray	3		160-180	20-30
Biscuits					
Viennese whirls	Baking tray	3		140-150**	25-40

* Preheat

** Preheat for 5 mins., do not use quick heat function

Dish	Accessories/cookware	Shelf position	Heating function	Temperature in °C	Cooking time in mins.
Viennese whirls	Baking tray	3		140-150**	25-40
Whirls, 2 levels	Universal pan + baking tray	3+1		140-150**	30-40
Whirls, 3 levels	Baking trays + universal pan	5+3+1		130-140**	35-55
Biscuits	Baking tray	3		140-160	15-30
Biscuits, 2 levels	Universal pan + baking tray	3+1		140-160	15-30
Biscuits, 3 levels	Baking trays + universal pan	5+3+1		140-160	15-30
Meringue	Baking tray	3		80-90*	120-150
Meringue, 2 levels	Universal pan + baking tray	3+1		80-90*	120-180
Macaroons	Baking tray	3		90-110	20-40
Macaroons, 2 levels	Universal pan + baking tray	3+1		90-110	25-45
Macaroons, 3 levels	Baking trays + universal pan	5+3+1		90-110	30-45
* Preheat					
** Preheat for 5 mins., do not use quick heat function					

Tips on baking

You want to find out whether the cake is completely cooked in the middle.	Push a cocktail stick into the highest point on the cake. If the cocktail stick comes out clean with no dough residue, the cake is ready.
The cake collapses.	Next time, use less liquid. Alternatively, set the temperature to be 10 °C lower and extend the baking time. Adhere to the specified ingredients and preparation instructions in the recipe.
The cake has risen in the middle but is lower around the edge.	Only grease the base of the springform cake tin. After baking, loosen the cake carefully with a knife.
The fruit juice overflows.	Next time, use the universal pan.
Small baked items stick to one another during baking.	There should be a gap of approx. 2 cm around each item. This gives enough space for the baked items to expand well and brown on all sides.
The cake is too dry.	Set the temperature 10 °C higher and shorten the baking time.
The cake is generally too light in colour.	If the shelf position and the cookware are correct, then you should increase the temperature if necessary or extend the baking time.
The cake is too light on top, and too dark underneath.	Bake the cake one level higher in the oven the next time.
The cake is too dark on top, and too light underneath.	Bake the cake one level lower in the oven the next time. Select a lower temperature and extend the baking time.
Cakes baked in a tray or tin are too brown at the back.	Place the baking tray in the middle of the accessories, not directly against the back wall.
The whole cake is too dark.	Select a lower temperature next time and extend the baking time if necessary.
The cake is unevenly browned.	Select a slightly lower temperature. Protruding greaseproof paper can affect the air circulation. Always cut greaseproof paper to size. Ensure that the baking tin does not stand directly in front of the openings in the cooking compartment back wall. When baking small items, you should use similar sizes and thicknesses wherever possible.
You were baking on several levels. The items on the top baking tray are darker than those on the lower baking tray.	Always select 4D hot air when baking on several levels. Baked items that are placed into the oven on trays or in baking tins/dishes at the same time will not necessarily be ready at the same time.
The cake looks good, but is not cooked properly in the middle.	Use a lower temperature and bake slightly longer; if necessary, add slightly less liquid. For cakes with a moist topping, bake the base first. Sprinkle it with almonds or breadcrumbs and then place the topping on top.
The cake cannot be turned out of the dish when it is turned upside down.	Allow the cake to cool down for 5 to 10 minutes after baking. If it still sticks, carefully loosen the cake around the edges again using a knife. Turn the cake tin upside down again and cover it several times with a cold, wet cloth. Next time, grease the baking tin/dish and sprinkle with breadcrumbs.

Bread and rolls

Your appliance offers you a range of heating types for baking bread and rolls. You can find the ideal settings for many dishes in the settings tables.

Also refer to the notes in the section on allowing dough to rise.

Only use original accessories supplied with your appliance. These have been tailored to the cooking compartment and the operating modes of your appliance.

Shelf positions

Use the indicated shelf positions.

Baking on one level

When baking on one level, use the following shelf positions:

- Tall baked items: Level 2
- Flat baked items: Level 3

If you are using 4D Hot air as the type of heating, you can choose between levels 1, 2, 3 and 4.

Baking on two levels

Use 4D hot air. Baked items that are placed into the oven on trays or in baking tins/dishes at the same time will not necessarily be ready at the same time.

- Universal pan: Level 3
Baking tray: Level 1
- Baking tins/dishes on the wire rack
First wire rack: Level 3
Second wire rack: Level 1

By preparing several dishes at the same time, you can make energy savings of up to 45 per cent. Position baking tins/dishes next to one another or offset and vertically stacked in the cooking compartment.

Accessories

Ensure that you always use suitable accessories and that they are placed in the oven the right way around.

Wire rack

Insert the wire rack with the open side facing the appliance door and the curved lip pointing downwards. Always place ovenware, tins and dishes on the wire rack.

Universal pan or baking tray

Slide the universal pan or the baking tray in carefully as far as the limit stop with the bevelled edge facing the appliance door.

Baking tins

Dark- coloured metal baking tins are most suitable.

Tinplate baking tins, ceramic dishes and glass dishes extend baking time and mean that the baked item will not brown evenly. If you wish to bake using these baking tins/dishes and using top/bottom heating, slide in the tin/dish at level 1.

Greaseproof paper

Only use greaseproof paper that is suitable for the selected temperature. Always cut greaseproof paper to size.

Frozen products

Do not use frozen products that are heavily frosted. Remove any ice on the food.

Some frozen products may be unevenly pre-baked. Uneven browning may remain even after baking.

Recommended setting values

The table lists the optimal heating type for various kinds of bread and bread roll. The temperature and baking time depend on the amount and consistency of the dough/mixture. For this reason, the table specifies setting ranges. Try using the lower values to start with. A lower temperature will result in more even browning. You can use a higher setting next time if necessary.

Note: Baking times cannot be reduced by using higher temperatures. The bread or bread rolls would only be cooked on the outside, but would not be fully baked in the middle.

The setting values apply to food that is placed into a cold cooking compartment; by doing this, you can make energy savings of up to 20 per cent. If you preheat the oven, you can reduce the indicated baking times by several minutes.

Preheating is necessary for selected food, and this is indicated in the table. Do not place your food or accessories into the cooking compartment until it has finished preheating. Some food turns out best if it is baked in several stages. These foods are indicated in the table.

The setting values for bread dough apply to both dough placed on a baking tray and dough placed in a loaf tin.

If you wish to follow one of your own recipes when baking, you should use the setting values listed for similar baked items in the table as reference.

Remove unused accessories from the cooking compartment. This will ensure that you achieve the best possible cooking results and energy savings of up to 20 per cent.















Caution!

Never pour water into the hot cooking compartment or place cookware containing water onto the bottom of the cooking compartment. The change in temperature can cause damage to the enamel.

en Tested for you in our cooking studio

Types of heating used:

-  4D hot air
-  Top/bottom heating
-  Circulated air grilling
-  Grill, large area
-  coolStart function

Dish	Accessories	Shelf position	Type of heating	Temperature in °C	Grill setting	Cooking time in mins.
Bread						
White bread, 750 g	Universal pan or cake tin	2		210-220*	-	10-15
				180-190	-	25-35
Multigrain bread, 1.5 kg	Universal pan or cake tin	2		210-220*	-	10-15
				180-190	-	40-50
Wholemeal bread, 1 kg	Universal pan	2		210-220*	-	10-15
				180-190	-	40-50
Flatbread	Universal pan	3		250-270	-	20-25
Bread rolls						
Part-cooked rolls or baguette, pre-baked**	Universal pan	3		-	-	-
Bread rolls, sweet, fresh	Baking tray	3		170-190*	-	15-20
Bread rolls, sweet, fresh, 2 levels	Universal pan + baking tray	3+1		150-170*	-	20-30
Bread rolls, fresh	Baking tray	3		180-200	-	20-30
Baguette, pre-baked, chilled**	Universal pan	3		-	-	-
Bread rolls, frozen						
Part-cooked rolls or baguette, pre-baked**	Universal pan	3		-	-	-
Lye bread, pieces of dough**	Universal pan	3		-	-	-
Croissant, pieces of dough	Universal pan	3		170-190	-	30-35
Toast						
Toast with topping, 4 slices	Wire rack	3		190-210	-	10-15
Toast with topping, 12 slices	Wire rack	3		230-250	-	10-15
Toasting bread (do not preheat)	Wire rack	5		-	3	4-6
* Preheat						
** Observe the information on the packaging						

Pizza, quiche and savoury cakes

Your appliance offers you a range of heating types for preparing pizza, quiche and savoury cakes. You can find the ideal settings for many dishes in the settings tables.

Also refer to the notes in the section on allowing dough to rise.

Only use original accessories supplied with your appliance. These have been tailored to the cooking compartment and the operating modes of your appliance.

Shelf positions

Use the indicated shelf positions.

Baking on one level

When baking on one level, use the following shelf positions:

- Tall baked items: Level 2
- Flat baked items: Level 3

If you are using 4D Hot air as the type of heating, you can choose between levels 1, 2, 3 and 4.

Baking on several levels

Use 4D hot air. Baked items that are placed into the oven on trays or in baking tins/dishes at the same time will not necessarily be ready at the same time.

Baking on two levels:

- Universal pan: Level 3
Baking tray: Level 1
- Baking tins/dishes on the wire rack
First wire rack: Level 3
Second wire rack: Level 1

Baking on four levels:

- 4 wire racks with greaseproof paper
 - First wire rack: Level 5
 - Second wire rack: Level 3
 - Third wire rack: Level 2
 - Fourth wire rack: Level 1

By preparing several dishes at the same time, you can make energy savings of up to 45 per cent. Position baking tins/dishes next to one another or offset and vertically stacked in the cooking compartment.

Accessories

Ensure that you always use suitable accessories and that they are placed in the oven the right way around.

Wire rack

Insert the wire rack with the open side facing the appliance door and the curved lip pointing downwards. Always place ovenware, tins and dishes on the wire rack.

Universal pan or baking tray

Slide the universal pan or the baking tray in carefully as far as the limit stop with the bevelled edge facing the appliance door.

Use the universal pan for pizzas with many toppings.

Baking tins

Dark- coloured metal baking tins are most suitable.

Tinplate baking tins, ceramic dishes and glass dishes extend baking time and mean that the baked item will not brown evenly. If you wish to bake using these baking tins/dishes and using top/bottom heating, slide in the tin/dish at level 1.

Greaseproof paper

Only use greaseproof paper that is suitable for the selected temperature. Always cut greaseproof paper to size.

Frozen products

Do not use frozen products that are heavily frosted. Remove any ice on the food.

Some frozen products may be unevenly pre-baked. Uneven browning may remain even after baking.

Recommended setting values

The table lists the optimal heating type for various types of food. The temperature and baking time depend on the amount and consistency of the dough/mixture. For this reason, the table specifies setting ranges. Try using the lower values to start with. A lower temperature will result in more even browning. You can use a higher setting next time if necessary.

Note: Baking times cannot be reduced by using higher temperatures. The food would only be cooked on the outside, but would not be fully baked in the middle.





The setting values apply to food that is placed into a cold cooking compartment; by doing this, you can make energy savings of up to 20 per cent. If you preheat the oven, you can reduce the indicated baking times by several minutes.









Preheating is necessary for selected food, and this is indicated in the table. Do not place your food or accessories into the cooking compartment until it has finished preheating.









If you wish to follow one of your own recipes when baking, you should use the setting values listed for similar baked items in the table as reference.

Remove unused accessories from the cooking compartment. This will ensure that you achieve the best possible cooking results and energy savings of up to 20 per cent.

Types of heating used:

-  4D hot air
-  Top/bottom heating
-  Pizza setting
-  coolStart function

Dish	Accessories	Shelf position	Type of heating	Temperature in °C	Cooking time in mins.
Pizza					
Pizza, fresh	Baking tray	3		200-220	25-35
Pizza, fresh	Baking tray	3		200-220	25-35
Pizza, fresh, 2 levels	Universal pan + baking tray	3+1		180-200	35-45
Pizza, fresh, thin base	Pizza tray	2		220-230	20-30
Pizza, chilled**	Wire rack	3		-	-
Pizza, frozen					
Pizza with thin base x 1**	Wire rack	3		-	-
Pizza with thin base x 2	Universal pan + wire rack	3+1		190-210	20-25
Pizza, deep-pan, x 1**	Wire rack	3		-	-
Pizza, deep-pan, x 2	Universal pan + wire rack	3+1		190-210	20-30
* Preheat					
** Observe the information on the packaging					

Dish	Accessories	Shelf position	Type of heating	Temperature in °C	Cooking time in mins.
Pizza baguette**	Wire rack	3		-	-
Mini pizzas**	Universal pan	3		-	-
Mini pizzas, diameter 7 cm, 4 levels	4 wire racks	5+3+2+1		180-200*	20-30
Savoury cakes and quiches					
Savoury cakes in a tin	Springform cake tin, diameter 28 cm	2		170-190	55-65
Quiche	Flan-base cake tin, black	3		190-210	30-40
Tarte flambée	Universal pan	3		260-280*	10-15
Pierogi	Ovenproof dish	2		190-200	30-45
Empanada	Universal pan	3		180-190	30-45
Börek	Universal pan	1		200-220*	20-30
* Preheat					
** Observe the information on the packaging					

Bakes and soufflés

Your appliance offers a range of heating types for preparing bakes and soufflés. You can find the ideal settings for many dishes in the settings tables.

Only use original accessories supplied with your appliance. These have been tailored to the cooking compartment and the operating modes of your appliance.

Shelf positions

Always use the indicated shelf positions.

You can prepare dishes on one level using a baking tin/dish or the universal pan.

- Baking tins/dishes on the wire rack: Level 2
- Universal pan: Level 3

You can also prepare soufflés in a water bath in the universal pan. To do so, slide the universal pan in at level 2.

By preparing several dishes at the same time, you can make energy savings of up to 45 per cent. Position baking tins/dishes next to one another in the cooking compartment.

Accessories

Ensure that you always use suitable accessories and that they are placed in the oven the right way around.

Wire rack

Insert the wire rack with the open side facing the appliance door and the curved lip pointing downwards. Always place ovenware, tins and dishes on the wire rack.

Universal pan

Slide in the universal pan carefully as far as the limit stop, with the bevelled edge facing the appliance door.

Cookware

Use wide, shallow cookware for bakes and gratins. In deep, narrow cookware, food requires more time to cook, and the top will be darker.

Recommended setting values

In the table, you can find the ideal heating type for various bakes and soufflés. The temperature and cooking time are dependent on the quantity of food and the recipe. How well cooked a bake is will depend on the size of the cookware and the depth of the bake. Settings ranges are indicated for this reason. Try using the lower values at first. A lower temperature results in more even browning. You can increase the temperature next time if necessary.



Note: Cooking times cannot be reduced by using higher temperatures. Bakes or soufflés would only be cooked on the outside, but would be raw in the middle.



The setting values apply to dishes placed into a cold cooking compartment. By doing so, you can make energy savings of up to 20 per cent. If you preheat the oven, the indicated cooking times will be reduced by several minutes.









If you wish to follow one of your own recipes when cooking, you can use similar dishes in the table as a reference.

Remove unused accessories from the cooking compartment. This will achieve the best possible cooking results and energy savings of up to 20 per cent.

Types of heating used:

-  4D hot air
-  Top/bottom heating

-  Pizza setting
-  coolStart function

Bakes & soufflés	Accessories/cookware	Shelf position	Type of heating	Temperature in °C	Cooking time in mins.
Bake, savoury, cooked ingredients	Ovenproof dish	2		200-220	30-50
Bake, sweet	Ovenproof dish	2		170-190	40-60
Lasagne, fresh, 1 kg	Ovenproof dish	2		160-180	50-60
Lasagne, frozen, 400 g*	Wire rack	2		-	-
Potato gratin, raw ingredients, 4 cm deep	Ovenproof dish	2		160-190	50-70
Potato gratin, raw ingredients, 4 cm deep, 2 levels	Ovenproof dish	3+1		150-170	60-80
Soufflé	Ovenproof dish	2		160-180*	35-45
Soufflé	Individual moulds	2		170-190	65-75

* Observe information on the packaging

Poultry

Your appliance offers you a range of heating types for preparing poultry. You can find the ideal settings for certain dishes in the settings tables.

Roasting on the wire rack

Roasting on the wire rack is particularly well suited for larger poultry or for multiple pieces at the same time.

Slide the universal pan into the oven at the indicated shelf position with the wire rack attached. Ensure that the wire rack is correctly positioned on the universal pan. → "Accessories" on page 10

Depending on the size and type of the poultry, pour up to ½ litres of water into the universal pan. Any dripping fat will be caught. You can make a sauce from these juices. This will also result in less smoke and ensure that the cooking compartment stays cleaner.

Roasting in cookware

Only use cookware which is suitable for use in an oven. Check whether the cookware fits in the cooking compartment.

Glass cookware is most suitable. Place hot glass cookware onto a dry mat after cooking. If the surface is damp or cold, the glass may crack.

Shiny roasting dishes made from stainless steel or aluminium reflect heat like a mirror and are therefore not particularly suitable. The poultry cooks slower and does not brown so well. Use a higher temperature and/or a longer cooking time.

Observe the manufacturer's instructions for your roasting cookware.

Uncovered cookware

It is best to use a deep roasting tin/dish for roasting poultry. Place the tin/dish onto the wire rack. If you do not have any suitable cookware, use the universal pan.

Covered cookware

When cooking with covered cookware, the cooking compartment remains considerably cleaner. Ensure that

the lid fits well and closes properly. Place the cookware onto the wire rack.

Very hot steam may escape when opening the lid after cooking. Lift the lid at the rear, so that the hot steam can escape away from you.

Poultry can also become crispy in a covered roasting dish. To do so, use a roasting dish with a glass lid and set a higher temperature.

Grilling

Keep the appliance door closed when using the grill. Never grill with the appliance door open.

Place the food to be grilled on the wire rack. In addition, slide the universal pan in at least one shelf position lower, with the slanted edge facing the appliance door. Any dripping fat will be caught.

When grilling, try wherever possible to use pieces of food which are of a similar thickness and weight. This will allow them to brown evenly and remain succulent and juicy. Place the food to be grilled directly onto the wire rack.

Use tongs to turn the pieces of food you are grilling. If you pierce the meat with a fork, the juices will run out and it will become dry.

Notes

- The grill element switches itself continuously on and off; this is normal. The grill setting determines how frequently this occurs.
- Smoke may be produced when grilling.

Recommended setting values

In the table, you can find the ideal heating type for the kind of poultry you are cooking. The temperature and cooking time depend on the amount, composition and temperature of the food. Setting ranges are indicated for this reason. Try using the lower values at first. You can increase the temperature next time if necessary.

The setting values are based on the assumption that unstuffed, chilled, ready-to-roast poultry is placed into a cold cooking compartment. By doing so, you can make

energy savings of up to 20 per cent. If you preheat the oven, the indicated cooking times will be reduced by several minutes.

In the table, you can find specifications for poultry with default values for the weight. If you wish to cook heavier poultry, use the lower temperature in every case. If cooking multiple pieces, use the weight of the heaviest piece as a reference for determining the cooking time. The individual pieces should be approximately equal in size.

A general rule: the larger the poultry is, the lower the cooking temperature and the longer the cooking time.

Turn the poultry after approx. 1/2 to 2/3 of the indicated time.





Note: Only use greaseproof paper that is suitable for the selected temperature. Always cut greaseproof paper to size.













Tips

- For duck or goose, pierce the skin on the underside of the wings. This allows the fat to run out.
- If using duck breast, score the skin. Do not turn duck breasts.
- When you turn poultry, ensure that the breast side or the skin side is underneath at first.
- Poultry will turn out particularly crispy and brown if you baste it towards the end of the roasting time with butter, salted water or orange juice.

Remove unused accessories from the cooking compartment. This will achieve the best possible cooking results and energy savings of up to 20 per cent.

Types of heating used:

-  Top/bottom heating
-  Circulated air grilling
-  Grill, large area
-  coolStart function

Dish	Accessories/cookware	Shelf position	Type of heating	Temperature in °C	Grill setting	Cooking time in mins.
Chicken						
Chicken, 1 kg	Wire rack	2		200-220	-	60-70
Chicken breast fillet, 150 g each (grilling)	Wire rack	4		-	3*	15-20
Small chicken portions, 250 g each	Wire rack	3		220-230	-	30-35
Chicken goujons, nuggets, frozen	Universal pan	3		-	-	-
Poulard, 1.5 kg	Wire rack	2		200-220	-	70-90
Duck and goose						
Duck, 2 kg	Wire rack	1		180-200	-	90-110
Duck breast, 300 g each	Wire rack	3		230-250	-	25-30
Goose, 3 kg	Wire rack	2		160-180	-	120-150
Goose legs, 350 g each	Wire rack	2		210-230	-	40-50
Turkey						
Small turkey, 2.5 kg	Wire rack	2		180-200	-	70-90
Turkey breast, boned, 1 kg	Cookware, covered	2		240-260	-	80-100
Turkey thigh, with bone, 1 kg	Wire rack	2		180-200	-	80-100
* Preheat for 5 mins						

Meat

Your appliance offers you many heating types for preparing meat. You can find the ideal settings for many dishes in the settings tables.

Roasting and braising

Baste lean meat with fat as required or cover it with strips of bacon.

Score the rind crosswise. If you turn the joint when cooking, ensure that the rind is underneath at first.

When the joint is ready, turn off the oven and allow it to rest for another 10 minutes in the cooking compartment. This allows the meat juices to be better

distributed. Wrap the joint in aluminium foil if necessary. The recommended standing time is not included in the cooking time specified.

Roasting on the wire rack

On the wire rack, meat will become very crispy on all sides.

Pour up to 1/2 litres of water into the universal pan, depending on the size and type of the meat. Dripping fat and meat juices will be caught. You can make a sauce using these juices. This will also result in less smoke and ensure that the cooking compartment stays cleaner.

Slide the universal pan into the oven at the indicated shelf position with the wire rack attached. Ensure that the wire rack is correctly positioned on the universal pan. → "Accessories" on page 10

Roasting and braising in cookware

It is more convenient to roast and braise meat in cookware. You can take the joint out of the cooking compartment more easily in the cookware, and prepare the sauce in the cookware itself.

Only use cookware which is suitable for use in an oven. Check whether the cookware fits in the cooking compartment.

Glass cookware is most suitable. Place hot glass cookware onto a dry mat after cooking. If the surface is damp or cold, the glass may crack.

Add in a little liquid for roasting if the meat is lean. A covering of approx. 1/2 cm depth should be applied to the base of any glass cookware.

The amount of liquid is dependent on the type of meat, the cookware material and also on whether or not a lid is used. If preparing meat in an enamelled or dark metal roasting dish, it will need a little more liquid than if cooked in glass cookware.

The steam evaporates in the cookware when roasting. Carefully pour in more liquid if required.

Shiny roasting dishes made from stainless steel or aluminium reflect heat like a mirror and are therefore not particularly suitable. The meat cooks more slowly and will not brown so much. Use a higher temperature and/or a longer cooking time.

Observe the manufacturer's instructions for your roasting cookware.

Uncovered cookware

Use a deep roasting tin/dish for roasting meat. Place the tin/dish onto the wire rack. If you do not have any suitable cookware, use the universal pan.

Covered cookware

When cooking with covered cookware, the cooking compartment remains considerably cleaner. Ensure that the lid fits well and closes properly. Place the cookware onto the wire rack.

The distance between the meat and the lid must be at least 3 cm. The meat may rise.

Very hot steam may escape when opening the lid after cooking. Lift the lid at the rear, so that the hot steam can escape away from you.

If necessary, braise the meat first by searing it. Add water, wine, vinegar or a similar liquid to the braising liquid. A covering approx. 1-2 cm deep should be applied to the base of the cookware.

The steam evaporates in the cookware when roasting. Carefully pour in more liquid if required.

Meat can also become crispy in a covered roasting dish. To do so, use a roasting dish with a glass lid and set a higher temperature.

Grilling

Keep the appliance door closed when using the grill. Never grill with the appliance door open.

Place the food to be grilled on the wire rack. In addition, slide the universal pan in at least one shelf position lower, with the slanted edge facing the appliance door. Any dripping fat will be caught.

When grilling, try wherever possible to use pieces of food which are of a similar thickness and weight. This will allow them to brown evenly and remain succulent and juicy. Place the food to be grilled directly onto the wire rack.

Use tongs to turn the pieces of food you are grilling. If you pierce the meat with a fork, the juices will run out and it will become dry.

Do not add salt until after the meat has been grilled. Salt draws water from the meat.

Notes

- The grill element switches itself continuously on and off; this is normal. The grill setting determines how frequently this occurs.
- Smoke may be produced when grilling.

Recommended setting values

You can find the ideal heating type for many meat dishes in the table. Temperature and cooking time depend on the amount, composition and temperature of the food. Settings ranges are indicated for this reason. Try using the lower values at first. You can increase the temperature next time if necessary.

The setting values apply to chilled meat placed into the cold cooking compartment. By doing so, you can make energy savings of up to 20 per cent. If you preheat the oven, you can reduce the indicated cooking times by several minutes.

You can find information on roasts and default values for weights in the table. If you wish to roast a heavy joint of meat, you should definitely use a lower temperature. If roasting several joints, use the weight of the heaviest piece as a basis for determining the cooking time. The individual pieces should be approximately equal in size.

As a general rule: the larger a roasting joint is, the lower the cooking temperature and the longer the cooking time.

Turn roasting joints and grilled items after approx. 1/2 to 2/3 of the indicated time.

If you wish to follow one of your own recipes, you should use similar dishes as a reference. You can find additional information in the tips on roasting, braising and grilling attached to the settings table.

Remove unused accessories from the cooking compartment. This will achieve the best possible cooking results and energy savings of up to 20 per cent.

en Tested for you in our cooking studio

Types of heating used:

■ □ Top/bottom heating

■ □ Circulated air grilling

■ □ Grill, large area

Dish	Accessories/cookware	Shelf position	Type of heating	Temperature in °C	Grill setting	Cooking time in mins.
Pork						
Joint of pork without rind, e.g. neck, 1.5 kg	Cookware, uncovered	2	□	180-190	-	110-130
Joint of pork with rind, e.g. shoulder, 2 kg	Wire rack	2	□	190-200	-	130-140
Pork tenderloin steak, 1.5 kg	Cookware, uncovered	2	□	220-230	-	70-80
Fillet of pork, 400 g	Wire rack	3	□	220-230	-	20-25
Smoked pork on the bone, 1 kg (with a little added water)	Cookware, covered	2	□	210-230	-	70-90
Pork steaks, 2 cm thick	Wire rack	5	□	-	2	16-20
Pork medallions, 3 cm thick (preheat oven for 5 mins.)	Wire rack	5	□	-	3*	8-12
Beef						
Fillet of beef, medium, 1 kg	Wire rack	2	□	210-220	-	40-50
Pot-roasted beef, 1.5 kg	Cookware, covered	2	□	200-220	-	130-160
Sirloin, medium, 1.5 kg	Wire rack	2	□	220-230	-	60-70
Steak, 3 cm thick, medium (do not pre-heat)	Wire rack	3	□	-	3	15-20
Burger, 3-4 cm thick	Wire rack	4	□	-	3	25-30
Veal						
Joint of veal, 1.5 kg	Cookware, uncovered	2	□	160-170	-	100-120
Knuckle of veal, 1.5 kg	Cookware, uncovered	2	□	200-210	-	100-120
Lamb						
Leg of lamb, boned, medium, 1.5 kg	Cookware, uncovered	2	□	170-190	-	50-80
Saddle of lamb on the bone**	Wire rack	2	□	180-190	-	40-50
Lamb chop	Wire rack	3	□	-	3	12-16
Sausages						
Grilled sausages	Wire rack	4	□	-	3	10-15
Meat dishes						
Meat loaf, 1 kg	Cookware, uncovered	2	□	170-180	-	60-70

* Preheat

** Do not turn

Tips on roasting and braising

The cooking compartment becomes very dirty.	Prepare your food in an enclosed roasting dish with higher temperature or use the grill tray. You will achieve the best roasting results if you use the grill tray. The grill tray can be bought later as a special accessory.
The roast is too dark and the crackling is burned in places, and/or the roast is too dry.	Check the shelf position and temperature. Select a lower temperature the next time and reduce the roasting time if necessary.
The crackling is too thin.	Increase the temperature or switch on the grill briefly at the end of the roasting time.
The roast looks good but the juices are burnt.	Next time, use a smaller roasting dish and add more liquid if necessary.

The roast looks good but the juices are too clear and watery.	Next time, use a larger roasting dish and add less liquid if necessary.
The meat gets burned during braising.	The roasting dish and lid must fit together well and close properly. Reduce the temperature and add more liquid when braising if necessary.

Fish

Your appliance offers you a range of heating types for preparing fish. You can find the ideal settings for many dishes in the settings tables.

The whole fish does not have to be turned. Place the whole fish into the cooking compartment in swimming position with the dorsal fin facing upwards. Placing half a potato or a small oven-proof container in the stomach cavity of the fish will provide stability.

You can tell when the fish is cooked because the dorsal fin can be removed easily.

Roasting and grilling on the wire rack

Place the food to be grilled on the wire rack. In addition, slide the universal pan in at least one shelf position lower, with the slanted edge facing the appliance door.

Pour up to ½ litres of water into the universal pan, depending on the size and type of the fish. Any dripping liquid will be caught. Less smoke is generated and the cooking compartment stays cleaner.

Keep the appliance door closed when using the grill. Never grill with the appliance door open.

When grilling, try wherever possible to use pieces of food which are of a similar thickness and weight. This will allow them to brown evenly and remain succulent and juicy. Place the food to be grilled directly onto the wire rack.

Use tongs to turn the pieces of food you are grilling. If you pierce the fish with a fork, the juices will run out and it will become dry.

Notes

- The grill element switches itself continuously on and off; this is normal. The grill setting determines how frequently this occurs.
- Smoke may be produced when grilling.

Roasting and stewing in cookware

Only use cookware which is suitable for use in an oven. Check whether the cookware fits in the cooking compartment.

Glass cookware is most suitable. Place hot glass cookware onto a dry mat after cooking. If the surface is damp or cold, the glass may crack.

Shiny roasting dishes made from stainless steel or aluminium reflect heat like a mirror and are therefore not particularly suitable. The fish cooks more slowly and browns less. Use a higher temperature and/or a longer cooking time.

Observe the manufacturer's instructions for your roasting cookware.

Uncovered cookware

To cook a whole fish, it is best to use a deep roasting tin/dish. Place the tin/dish onto the wire rack. If you do not have any suitable cookware, use the universal pan.

Covered cookware

When cooking with covered cookware, the cooking compartment remains considerably cleaner. Ensure that the lid fits well and closes properly. Place the cookware onto the wire rack.

When stewing, add two to three tablespoons of liquid and a little lemon juice or vinegar into the cookware.

Very hot steam may escape when opening the lid after cooking. Lift the lid at the rear, so that the hot steam can escape away from you.

Fish can also become crispy in a covered roasting dish. Here, use a roasting dish with a glass lid and set a higher temperature.

Recommended setting values

You can find the ideal heating type for your fish dishes in the table. The temperature and cooking time depend on the amount, composition and temperature of the food. Settings ranges are indicated for this reason. Try using lower setting values first. You can use a higher setting next time if necessary.

The setting values are based on the assumption that chilled fish is placed into a cold cooking compartment. By doing so, you can make energy savings of up to 20 per cent. If you preheat the oven, you can reduce the indicated cooking times by several minutes.

In the table, you can find information for fish with default values for the weight. If you want to cook a heavier fish, you should definitely use the lower temperature. If cooking several fish, you should use the weight of the heaviest fish as a reference for determining the cooking time. The individual fish should be approximately the same size.

As a general rule: the larger a fish, the lower the cooking temperature and the longer the cooking time.

Turn any fish which is not in swimming position after approx. ½ to ⅔ of the indicated time.

Note: Only use greaseproof paper that is suitable for the selected temperature. Always cut greaseproof paper to size.

Remove unused accessories from the cooking compartment. This will achieve the best possible cooking results and energy savings of up to 20 per cent.

en Tested for you in our cooking studio

Types of heating used:

■ □ Top/bottom heating

- ☒ Circulated air grilling
- ☐ Grill, large area

Dish	Accessories/cookware	Shelf position	Type of heating	Temperature in °C	Grill setting	Cooking time in mins.
Fish						
Fish, grilled, whole 300 g, e.g. trout	Wire rack	2	☒	170-190	-	20-30
Fish, grilled, whole 1.5 kg, e.g. salmon	Wire rack	2	☒	170-190	-	30-40
Fish fillets						
Fish fillet, plain, grilled	Wire rack	4	☐	-	1*	15-25
Fish steaks						
Fish steak, 3 cm thick**	Wire rack	4	☐	-	3	10-20
Fish, frozen						
Fish fillet, plain	Cookware, covered	2	□	210-230	-	20-30
Fish fillet, au gratin	Wire rack	2	☒	200-220	-	45-60
Fish fingers (turn during cooking)	Universal pan	3	□	200-220	-	20-30
* Preheat						
** Slide the universal pan in underneath at shelf position 2						

Vegetables and side dishes

Here, you can find information for preparing grilled vegetables, potatoes and frozen potato products.

Remove unused accessories from the cooking compartment. This will allow you to achieve ideal cooking results and save energy.

Shelf positions

Use the indicated shelf positions.

Cooking on one level

Adhere to the specifications in the table.

Cooking on two levels

Use 4D hot air. Food on different baking trays placed in the oven at the same time will not necessarily be ready at the same time.

- Universal pan: Level 3
- Baking tray: Level 1

Accessories

Ensure that you always use suitable accessories and that they are placed in the oven the right way around.

Wire rack

Insert the wire rack with the open side facing the appliance door and the curved lip pointing downwards. Always place ovenware, tins and dishes on the wire rack.

Universal pan or baking tray

Slide the universal pan or the baking tray in carefully as far as the limit stop with the bevelled edge facing the appliance door.

Greaseproof paper

Only use greaseproof paper that is suitable for the selected temperature. Always cut greaseproof paper to size.

Recommended setting values



In the table, you can find the ideal heating types for various dishes. The temperature and cooking time depend on the amount and composition of the food. Setting ranges are indicated for this reason. Try using the lower values at first. A lower temperature results in more even browning. You can use a higher setting next time if necessary.







The setting values apply to dishes placed into a cold cooking compartment. If you preheat the oven, the indicated cooking times will be reduced by several minutes.

If you wish to follow one of your own recipes when cooking, you can use similar dishes in the table as a reference.

Types of heating used:

-  4D hot air

-  Grill, large area
-  coolStart function

Dish	Accessories	Shelf position	Type of heating	Temperature in °C	Grill setting	Cooking time in mins.
Vegetable dishes						
Grilled vegetables	Universal pan	5		-	3	10-15
Potatoes						
Baked potatoes, halved	Universal pan	3		160-180	-	45-60
Potato products, frozen						
Potato rösti*	Universal pan	3		-	-	-
Potato pockets, filled*	Universal pan	3		-	-	-
Croquettes*	Universal pan	3		-	-	-
Chips*	Universal pan	3		-	-	-
Chips, 2 levels	Universal pan + baking tray	3+1		190-210	-	30-40
* Observe information on the packaging						

Yogurt

You can make your own yogurt using your appliance.

Making yoghurt

Remove accessories and shelf supports from the cooking compartment. The cooking compartment must be empty. Do not open the appliance door while the appliance is in operation.

1. Heat 1 litre of milk (3.5% fat) to 90 °C on the hob and then leave it to cool down to 40 °C.

It is sufficient to heat UHT milk to 40 °C.

2. Stir in 150 g (chilled) yoghurt.
3. Pour into cups or small jars and cover with cling film.
4. Place the cups or jars onto the cooking compartment floor and use the settings indicated in the table.
5. After making the yoghurt, leave it to cool in the refrigerator.

Type of heating used:

-  4D hot air

Dish	Accessories	Shelf position	Type of heating	Temperature in °C	Cooking time in hours
Yogurt	Individual moulds	Cooking compartment floor		40-45	8-9

Eco heating functions

Hot air eco and Top/bottom heating eco are intelligent heating functions that allow you to gently cook meat, fish and baked items. The appliance optimally controls the supply of energy to the cooking compartment. The food is cooked in phases using residual heat. This means that it remains more succulent and browns less. Depending on the method of preparation and the type of food, it is possible to save energy. If you open the appliance door before the food has finished cooking or if you preheat the appliance, you may not be able to achieve this result.

Only use genuine accessories for your appliance. These have been tailored to the cooking compartment and the operating modes of your appliance. Remove any accessories that are not being used from the cooking compartment.

Place the food into the empty cooking compartment before the oven is heated up. For Hot air eco, select a

temperature of between 125 and 275 °C, and for Top/bottom heating eco, select a temperature of between 150 and 250 °C. Always keep the appliance door closed when cooking. Only cook on one level when using this function.

The Hot air eco heating function is used to measure both the energy consumption in air recirculation mode and the energy efficiency class. The Top/bottom heating eco heating function is used to measure the energy consumption in the conventional mode.

The Hot air eco heating type is used to determine the energy efficiency class.

Accessories

Ensure that you always use suitable accessories and that they are placed in the oven the right way around.

Wire rack

Insert the wire rack with the open side facing the appliance door and the curved lip pointing downwards.

Always place ovenware, tins and dishes on the wire rack.

Universal pan or baking tray

Slide the universal pan or the baking tray in carefully as far as the limit stop with the bevelled edge facing the appliance door.

Baking tins and cookware

Dark- coloured metal baking tins are most suitable. These allow you to make energy savings of up to 35 per cent.

Cookware made from stainless steel or aluminium reflects heat like a mirror. Non-reflective cookware made from enamel, heat-resistant glass or coated, die-cast aluminium is more suitable.

Tinplate baking tins, ceramic dishes or glass dishes prolong baking time, and the cake will not brown so evenly.

Greaseproof paper

Only use greaseproof paper that is suitable for the



selected temperature. Always cut greaseproof paper to size.























Recommended setting values

Here, you can find specifications for various dishes. The temperature and baking time are dependent on the quantity and composition of the dough. Different settings ranges are indicated for this reason. Try using the lower values at first. A lower temperature results in more even browning. If necessary, use a higher setting the next time.

Note: Baking times can not be reduced by using higher temperatures. Cakes or baked items would only be cooked on the outside, but would not be cooked completely in the middle.

Types of heating used:

-  Hotair Eco
-  Top/bottom heating Eco

Dish	Accessories/cookware	Shelf position	Type of heating	Temperature in °C	Cooking time in mins.
Cakes in tins					
Sponge cake in a tin	Ring tin/cake tin	2		140-160	60-80
Sponge flan base	Flan base tin	2		150-170	20-30
Sponge base, 2 eggs	Flan base tin	2		150-170	20-30
Sponge flan, 3 eggs	Springform cake tin, diameter 26 cm	2		160-170	30-45
Sponge flan, 6 eggs	Springform cake tin, diameter 28 cm	2		150-160	50-60
Bundt yeast cake	Ring cake tin	2		150-170	50-70
Cakes on baking trays					
Sponge cake with dry topping	Baking tray	3		150-170	25-40
Shortcrust tart with dry topping	Baking tray	3		170-180	25-35
Swiss roll	Baking tray	3		180-190	15-20
Plaited loaf, savarin	Baking tray	3		160-170	25-35
Yeast cake with dry topping	Baking tray	3		160-180	15-20
Small baked items					
Muffins	Muffin tray	2		160-180	15-25
Small cakes	Baking tray	3		150-160	25-35
Puff pastry	Baking tray	3		170-190	20-35
Choux pastry	Baking tray	3		200-220	35-45
Biscuits	Baking tray	3		140-160	15-30
Whirls	Baking tray	3		140-150	25-35
Small yeast cakes	Baking tray	3		160-180	25-35
Bread and bread rolls					
Multigrain bread, 1.5 kg	Cake tin	2		200-210	35-45
Flatbread	Universal pan	3		250-275	15-20
Bread rolls, sweet, fresh	Baking tray	3		170-190	15-20
Bread rolls, fresh	Baking tray	3		180-200	20-30

Dish	Accessories/cookware	Shelf position	Type of heating	Temperature in °C	Cooking time in mins.
Meat					
Joint of pork without rind, e.g. neck, 1.5 kg	Cookware, uncovered	2		180-190	120-140
Pot-roasted beef, 1.5 kg	Cookware, covered	2		200-220	140-160
Joint of veal, 1.5 kg	Cookware, uncovered	2		170-180	110-130
Fish					
Fish, braised, whole 300 g, e.g. trout	Cookware, covered	2		190-210	25-35
Fish, braised, whole 1.5 kg, e.g. salmon	Cookware, covered	2		190-210	45-55
Fish fillet, plain, braised	Cookware, covered	2		190-210	15-25

Acrylamide in foodstuffs

Acrylamide is mainly produced in grain and potato products prepared at high temperatures, such as potato

crisps, chips, sliced bread, bread rolls, bread or fine baked goods (biscuits, gingerbread, spiced biscuit).

Tips for keeping acrylamide to a minimum	
General	<ul style="list-style-type: none"> Keep cooking times as short as possible. Cook food until it is golden brown, but not too dark. Large, thick pieces of food contain less acrylamide.
Baking	With top/bottom heating at max. 200 °C. With hot air at max. 180 °C.
Biscuits	With top/bottom heating at max. 190 °C. With hot air at max. 170 °C. Egg or egg yolk reduces the production of acrylamide.
Oven chips	Spread out a single layer evenly on the baking tray. Cook at least 400 g at once on a baking tray so that the chips do not dry out.

Drying

With 4D hot air, you can dry foods with outstanding results. With this type of preserving, flavourings are concentrated by the dehydration.

Only use unblemished fruit, vegetables and herbs and wash them thoroughly. Line the wire rack with greaseproof paper or parchment paper. Drain the excess water from the fruit and dry it.

If necessary, cut it into equal chunks or thin slices. Place unpeeled fruit onto the dish with the sliced surfaces facing upwards. Ensure that neither fruit nor mushrooms overlap on the wire rack.

Grate vegetables and then blanch them. Allow the blanched vegetables to drain off and distribute them evenly on the wire rack.

Dry herbs on the stem. Position the herbs evenly and slightly heaped on the wire rack.

Use the following shelf positions for drying:

- 1 wire rack: Level 3

- 2 wire racks: Level 3+1

Turn very juicy fruit and vegetables several times. After drying, remove the dried products from the paper immediately.

Recommended setting values



In the table, you can find settings for drying various foodstuffs. The temperature and cooking time are dependent on the type, moisture, ripeness and thickness of the food to be dried. The longer you leave the food to be dried, the better it will be preserved. The thinner the slices are, the quicker the drying process will be and the more aromatic the dried food will remain. Setting ranges are indicated for this reason.

If you wish to dry additional foodstuffs, you should use similar foodstuffs in the table as a reference.

Type of heating used:

- 4D hot air

Fruit, vegetables and herbs	Accessories	Type of heating	Temperature in °C	Cooking time in hours
Pomes (apple rings, 3 mm thick, 200 g per wire rack)	1-2 wire racks		80	5-9
Stone fruit (plums)	1-2 wire racks		80	8-10

Fruit, vegetables and herbs	Accessories	Type of heating	Temperature in °C	Cooking time in hours
Root vegetables (carrots), grated, blanched	1-2 wire racks		80	5-8
Sliced mushrooms	1-2 wire racks		60	6-9
Herbs, washed	1-2 wire racks		60	2-6

Preserving

You can preserve fruit and vegetables using your appliance.

Warning – Risk of injury!

If the food is preserved incorrectly, the preserving jars may burst. Follow the instructions for preserving.

Jars

Use only clean and undamaged preserving jars. Only use heat-resistant, clean and undamaged rubber rings. Check clips and clamps in advance.

For each preserving process, only use preserving jars that are the same size and contain the same food. In the cooking compartment, you can preserve the contents of a maximum of six ½, 1 or 1½-litre preserving jars at the same time. Do not use jars that are larger or taller than this. The lids could rupture.

Preserving jars must not touch one another in the cooking compartment during the preserving process.

Preparing fruit and vegetables

Only use fruit and vegetables that are in good condition. Wash them thoroughly.

Peel, core and chop fruit and vegetables appropriate to their type and fill the preserving jars with them up to approx. 2 cm below the rim.

Fruit

Fill the preserving jars with the fruit along with a hot, skimmed sugar solution (approx. 400 ml for a 1-litre jar). For one litre of water:

- Approx. 250 g sugar for sweet fruit
- Approx. 500 g sugar for sour fruit

Vegetables

Fill the jars with the vegetables along with hot, boiled water.

Wipe the rims of the jars, as they must be clean. Place a damp rubber ring and a lid on each jar. Seal the jars with clamps. Place the jars into the universal pan so that they do not touch each other. Pour 500 ml hot water (approx. 80 °C) into the universal pan. Use the settings indicated in the table.

Ending the preserving process

Fruit

After a short while, small bubbles will form at short intervals. Switch off the appliance once all preserving jars are bubbling. Remove the jars from the cooking compartment after the indicated cooling time.

Vegetables

After a short while, small bubbles will form at short intervals. As soon as all preserving jars are bubbling, reduce the temperature to 120 °C and allow the jars to continue to bubble in the closed cooking compartment as indicated in the table. After this time has elapsed, switch off the appliance and make use of the residual heat for several minutes as indicated in the table.



After preserving, remove the jars from the cooking compartment and place them onto a clean cloth. Do not place these hot jars onto a cold or damp surface, as they may crack. Cover the preserving jars to protect them from draughts. Only remove the clamps once the jars are cold.

Recommended setting values

The indicated times in the settings table are average values for preserving fruit and vegetables. They may be influenced by room temperature, the number of jars, quantity, heat and quality of the jar contents. The specifications are based on 1-litre round jars. Before you switch off the appliance or change the cooking mode, check whether the contents of the jars are bubbling as they should. The bubbling process starts after approx. 30-60 minutes.

Type of heating used:

-  4D hot air

Preserving	Cookware	Shelf position	Type of heating	Temperature in °C	Cooking time in mins.
Vegetables, e.g. carrots	1-litre preserving jars	1		160-170	Before it starts bubbling:30-40
				120	When it starts to bubble: 30-40
				-	Residual heat: 30
Vegetables, e.g. cucumbers	1-litre preserving jars	1		160-170	Before it starts bubbling: 30-40
				-	Residual heat: 30
				-	-
Stone fruit, e.g. cherries, damsons	1-litre preserving jars	1		160-170	Before it starts bubbling:30-40
				-	Residual heat:35
				-	-

Preserving	Cookware	Shelf position	Type of heating	Temperature in °C	Cooking time in mins.
Pomes, e.g. apples, strawberries	1-litre preserving jars	1		160-170	Before it starts bubbling:30-40 Residual heat: 25

Prove dough

You can prove yeast dough in your appliance more quickly than at room temperature. Use the top/bottom heating type. Only start operation when the cooking compartment has fully cooled down.

Always allow yeast dough to prove twice. Observe the specifications in the settings tables for the 1st and 2nd proving processes (dough fermentation and final fermentation).

Dough fermentation

Use the settings indicated in the table and heat up the appliance. Position the dough bowl on the wire rack.

Do not open the appliance door during the proving process, as moisture will escape. Cover the dough with a damp cloth.

Final fermentation

Place your baked item into the oven at the shelf position indicated in the table.





If you want to preheat the oven, the final fermentation takes place outside the appliance in a warm place.

Recommended setting values

The temperature and proving time are dependent on the type and quantity of the ingredients. The values in the table are therefore only meant to be average values.

Type of heating used:

-  Top/bottom heating

Dish	Accessories/cookware	Shelf position	Type of heating	Step	Temperature in °C	Cooking time in mins.
Yeast dough, light	Bowl	2		Dough fermentation	35-40	25-30
	Baking tray	2		Final fermentation	35-40	10-20
Yeast dough, heavy and rich	Bowl	2		Dough fermentation	35-40	20-40
	Baking tray	2		Final fermentation	35-40	15-25

Defrosting

Use heating type 4D hot air to defrost fruit, vegetables and baked items. Poultry, meat and fish should ideally be defrosted in the refrigerator.

Use the following shelf positions when defrosting:

- 1 wire rack: Level 2
- 2 wire racks: Level 3+1

Recommended setting values

The times in the table are average values. They are dependent on the quality, freezing temperature (-18 °C) and composition of the food. Time ranges are indicated. Set the shortest time first and then extend the time if necessary.

Tip: Items which were frozen flat or portioned defrost faster than those frozen in a block.

Remove frozen food from the packaging and place it in suitable cookware onto the wire rack.



Stir the food or turn it once or twice in between. Large pieces of food should be turned several times. Occasionally split the food or remove items which have already defrosted from the cooking compartment.

Leave the defrosted food to rest for another 10 to 30 minutes in the appliance whilst it is switched off, so that the temperature balances out.

Type of heating used:

-  4D hot air

Dish	Accessories	Shelf position	Type of heating	Temperature in °C	Cooking time in mins.
Bread, bread rolls					
Bread & bread rolls general	Baking tray	2		50	40-70

Dish	Accessories	Shelf position	Type of heating	Temperature in °C	Cooking time in mins.
Cake					
Cake, moist	Baking tray	2		50	70-90
Cake, dry	Baking tray	2		60	60-75

Keeping warm

You can keep cooked dishes warm using the top/bottom heating type at 70 °C. This will avoid condensation developing, and means you will not have to wipe out the cooking compartment.

Do not keep cooked dishes warm for longer than two hours. Be aware that some dishes may continue cooking whilst being kept warm. Cover the dishes if necessary.

Test dishes

These tables have been produced for test institutes to facilitate appliance testing.

As per EN 60350-1.

Baking

Baked items that are placed into the oven on trays or in baking tins/dishes at the same time will not necessarily be ready at the same time.

Shelf positions for baking on two levels:

- Universal pan: Level 3
Baking tray: Level 1
- Baking tins/dishes on the wire rack
First wire rack: Level 3
Second wire rack: Level 1

Shelf positions for baking on three levels:

- Baking tray: Level 5

- Universal pan: Level 3
- Baking tray: Level 1

Apple pie

Apple pie on one level: place dark-coloured springform cake tins diagonally next to each other.

Apple pie on two levels: position dark-coloured springform cake tins above each other so that they are offset.

Cakes in tinplate springform cake tins: bake on one level with top/bottom heating. Place the springform cake tin onto the universal pan instead of onto the wire rack.



Fatless sponge cake











Fatless sponge cake on two levels: vertically stack springform cake tins in an offset manner on the wire racks.

Notes

- The setting values apply to dishes placed into a cold cooking compartment.
- Please note the information in the tables about preheating. The setting values are valid without rapid heating-up.
- For baking, use the lower of the indicated temperatures first.



Types of heating used:

-  4D hot air
-  Top/bottom heating
-  Pizza setting

Dish	Accessory	Shelf position	Type of heating	Temperature in °C	Cooking time in mins.
Baking					
Shortbread	Baking tray	3		140-150*	25-40
Shortbread	Baking tray	3		140-150*	25-40
Shortbread, 2 levels	Universal pan + baking tray	3+1		140-150*	30-40
Shortbread, 3 levels	Baking trays + universal pan	5+3+1		130-140*	35-55
Small cakes	Baking tray	3		160*	20-30
Small cakes	Baking tray	3		150*	25-35
Small cakes, 2 levels	Universal pan + baking tray	3+1		150*	25-35
Small cakes, 3 levels	Baking trays + universal pan	5+3+1		140*	35-45
Fatless sponge cake	Springform cake tin, diameter 26 cm	2		160-170**	25-35
Fatless sponge cake	Springform cake tin, diameter 26 cm	2		160-170**	30-40
Fatless sponge cake, 2 levels	Springform cake tin, diameter 26 cm	3+1		150-170**	30-50

* Preheat for 5 mins, do not use quick heat function

** Preheat, do not use quick heat function



Dish	Accessory	Shelf position	Type of heating	Temperature in °C	Cooking time in mins.
Apple pie	2 x black plate tins, diameter 20 cm	2		170-180	60-80
Apple pie	2 x black plate tins, diameter 20 cm	2		180-200	60-80
Apple pie, 2 levels	2 x black plate tins, diameter 20 cm	3+1		170-190	70-90
* Preheat for 5 mins, do not use quick heat function					
** Preheat, do not use quick heat function					

Grilling

Also slide in the universal pan. The liquid will be caught and the cooking compartment stays cleaner.

Type of heating used:

-  Grill, large area

Dish	Accessories	Shelf position	Type of heating	Grill setting	Cooking time in mins.
Grilling					
Toasting bread*	Wire rack	5		3	4-6
Beefburger, 12 pieces**	Wire rack	4		3	25-30
* Do not preheat					
** Turn after 2/3 of the total time					



A series of horizontal black lines spanning the width of the page, providing a template for writing. The lines are evenly spaced and extend from the left margin to the right edge of the page.

BSH Hausgeräte GmbH
Carl-Wery-Str. 34, 81739 München
GERMANY

siemens-home.bsh-group.com

Manufactured by BSH Hausgeräte GmbH under Trademark License of Siemens AG



9001006890
980327