

SIEMENS



# Built-in oven

CS656GB.1B

[siemens-home.com/welcome](https://siemens-home.com/welcome)

en Instruction manual

Register  
your  
product  
online



# Table of contents

 <b>Intended use</b> . . . . .	<b>4</b>	 <b>Time-setting options</b> . . . . .	<b>20</b>
 <b>Important safety information</b> . . . . .	<b>5</b>	Timer . . . . .	20
General information . . . . .	5	Cooking time . . . . .	20
Steam . . . . .	6	End time . . . . .	20
Cleaning function . . . . .	6	 <b>Childproof lock</b> . . . . .	<b>21</b>
 <b>Causes of damage</b> . . . . .	<b>6</b>	Activating and deactivating . . . . .	21
General information . . . . .	6	 <b>Basic settings</b> . . . . .	<b>22</b>
Steam . . . . .	7	Changing settings . . . . .	22
 <b>Environmental protection</b> . . . . .	<b>7</b>	List of settings . . . . .	22
Saving energy . . . . .	7	Changing the time . . . . .	22
Environmentally-friendly disposal . . . . .	7	 <b>Sabbath mode</b> . . . . .	<b>23</b>
 <b>Getting to know your appliance</b> . . . . .	<b>8</b>	Starting Sabbath mode . . . . .	23
Control panel . . . . .	8	 <b>Cleaning function</b> . . . . .	<b>23</b>
Controls . . . . .	8	Cleaning function . . . . .	23
Display . . . . .	8	Descaling . . . . .	24
Operating modes menu . . . . .	9	 <b>Cleaning agent</b> . . . . .	<b>25</b>
Types of heating . . . . .	9	Suitable cleaning agents . . . . .	25
Steam . . . . .	10	Surfaces in the cooking compartment . . . . .	26
Further information . . . . .	10	Keeping the appliance clean . . . . .	26
Cooking compartment functions . . . . .	10	 <b>Rails</b> . . . . .	<b>27</b>
Water tank . . . . .	11	Detaching and refitting the rails . . . . .	27
 <b>Accessories</b> . . . . .	<b>11</b>	 <b>Appliance door</b> . . . . .	<b>28</b>
Accessories included . . . . .	11	Removing and fitting the appliance door . . . . .	28
Inserting accessories . . . . .	12	Removing the door cover . . . . .	28
Optional accessories . . . . .	12	Removing and installing the door panels . . . . .	29
 <b>Before using for the first time</b> . . . . .	<b>13</b>	 <b>Trouble shooting</b> . . . . .	<b>30</b>
Before using for the first time . . . . .	13	Fault table . . . . .	30
Initial use . . . . .	13	Maximum operating time exceeded . . . . .	31
Calibrating the appliance and cleaning the cooking compartment . . . . .	14	Cooking compartment bulbs . . . . .	31
Cleaning the accessories . . . . .	14	 <b>Customer service</b> . . . . .	<b>31</b>
 <b>Operating the appliance</b> . . . . .	<b>15</b>	E number and FD number . . . . .	31
Switching the appliance on and off . . . . .	15	 <b>Dishes</b> . . . . .	<b>32</b>
Starting or interrupting operation . . . . .	15	Information on the settings . . . . .	32
Selecting an operating mode . . . . .	15	Selecting a dish . . . . .	32
Setting the type of heating and temperature . . . . .	15	Applying settings for dishes . . . . .	33
Rapid heat up . . . . .	16		
 <b>Steam</b> . . . . .	<b>16</b>		
Noise . . . . .	16		
FullSteam – Steam cooking . . . . .	16		
Steam-assisted cooking . . . . .	17		
Reheating . . . . .	17		
Prove dough . . . . .	17		
Defrosting . . . . .	18		
Filling the water tank . . . . .	18		
After every steam operation . . . . .	19		



**Tested for you in our cooking studio . . . . . 33**

Silicone moulds . . . . . 33  
 Baking . . . . . 33  
 Roasting and braising . . . . . 36  
 Grilling . . . . . 39  
 Convenience products . . . . . 42  
 Steaming . . . . . 44  
 Yogurt . . . . . 47  
 Eco types of heating . . . . . 47  
 Acrylamide in foodstuffs . . . . . 48  
 Slow cook . . . . . 48  
 Drying . . . . . 50  
 Preserving and juicing . . . . . 50  
 Sterilising bottles and hygiene . . . . . 51  
 Proving dough . . . . . 52  
 Defrosting . . . . . 52  
 Reheating . . . . . 53  
 Keeping warm . . . . . 54  
 Test dishes . . . . . 54

---

Additional information on products, accessories, replacement parts and services can be found at [www.siemens-home.com](http://www.siemens-home.com) and in the online shop [www.siemens-eshop.com](http://www.siemens-eshop.com)



**Intended use**

Read these instructions carefully. Only then will you be able to operate your appliance safely and correctly. Retain the instruction manual and installation instructions for future use or for subsequent owners.

This appliance is only intended to be fully fitted in a kitchen. Observe the special installation instructions.

Check the appliance for damage after unpacking it. Do not connect the appliance if it has been damaged in transport.

Only a licensed professional may connect appliances without plugs. Damage caused by incorrect connection is not covered under warranty.

This appliance is intended for domestic use only. The appliance must only be used for the preparation of food and drink. The appliance must be supervised during operation. Only use this appliance indoors.

This appliance is intended for use up to a maximum height of 2000 metres above sea level.

This appliance may be used by children over the age of 8 years old and by persons with reduced physical, sensory or mental capabilities or by persons with a lack of experience or knowledge if they are supervised or are instructed by a person responsible for their safety how to use the appliance safely and have understood the associated hazards.

Children must not play with, on, or around the appliance. Children must not clean the appliance or carry out general maintenance unless they are at least 8 years old and are being supervised.

Keep children below the age of 8 years old at a safe distance from the appliance and power cable.

Always slide accessories into the cooking compartment the right way round.

→ "Accessories" on page 11

## Important safety information

### General information

#### Warning – Risk of fire!

- Combustible items stored in the cooking compartment may catch fire. Never store combustible items in the cooking compartment. Never open the appliance door if there is smoke inside. Switch off the appliance and unplug it from the mains or switch off the circuit breaker in the fuse box.
- A draught is created when the appliance door is opened. Greaseproof paper may come into contact with the heating element and catch fire. Do not place greaseproof paper loosely over accessories during preheating. Always weight down the greaseproof paper with a dish or a baking tin. Only cover the surface required with greaseproof paper. Greaseproof paper must not protrude over the accessories.

#### Warning – Risk of burns!

- The appliance becomes very hot. Never touch the interior surfaces of the cooking compartment or the heating elements. Always allow the appliance to cool down. Keep children at a safe distance.
- Accessories and ovenware become very hot. Always use oven gloves to remove accessories or ovenware from the cooking compartment.
- Alcoholic vapours may catch fire in the hot cooking compartment. Never prepare food containing large quantities of drinks with a high alcohol content. Only use small quantities of drinks with a high alcohol content. Open the appliance door with care.

#### Warning – Risk of scalding!

- The accessible parts become hot during operation. Never touch the hot parts. Keep children at a safe distance.
- When you open the appliance door, hot steam can escape. Steam may not be visible, depending on its temperature. When opening, do not stand too close to the appliance. Open the appliance door carefully. Keep children away.
- Water in a hot cooking compartment may create hot steam. Never pour water into the hot cooking compartment.

#### Warning – Risk of injury!

- Scratched glass in the appliance door may develop into a crack. Do not use a glass scraper, sharp or abrasive cleaning aids or detergents.
- The hinges on the appliance door move when opening and closing the door, and you may be trapped. Keep your hands away from the hinges.

#### Warning – Risk of electric shock!

- Incorrect repairs are dangerous. Repairs may only be carried out and damaged power cables replaced by one of our trained after-sales technicians. If the appliance is defective, unplug the appliance from the mains or switch off the circuit breaker in the fuse box. Contact the after-sales service.
- The cable insulation on electrical appliances may melt when touching hot parts of the appliance. Never bring electrical appliance cables into contact with hot parts of the appliance.
- Do not use any high-pressure cleaners or steam cleaners, which can result in an electric shock.
- A defective appliance may cause electric shock. Never switch on a defective appliance. Unplug the appliance from the mains or switch off the circuit breaker in the fuse box. Contact the after-sales service.

#### Warning – Hazard due to magnetism!

Permanent magnets are used in the control panel or in the control elements. They may affect electronic implants, e.g. heart pacemakers or insulin pumps. Wearers of electronic implants must stay at least 10 cm away from the control panel.

## Steam

### **Warning – Risk of scalding!**

- The water in the water tank may become very hot if you continue to operate the appliance. Empty the water tank after every operation with steam.
- Hot steam is generated in the cooking compartment. Do not reach into the cooking compartment during any operation with steam.
- Hot liquid may spill over the sides of the accessory when it is removed from the cooking compartment. Remove hot accessories with care and always wear oven gloves.

### **Warning – Risk of injury and risk of fire!**

Flammable liquids can catch fire in the cooking compartment when it is hot (explosion). Do not fill the water tank with any flammable fluids (e.g. alcoholic drinks). Only fill the water tank with water or with the descaling solution that is recommended by us.

## Cleaning function

### **Warning – Risk of burns!**

 The appliance will become very hot on the outside during the cleaning function. Never touch the appliance door. Allow the appliance to cool down. Keep children away from the appliance.

## Causes of damage

### General information

#### Caution!

- Accessories, foil, greaseproof paper or ovenware on the cooking compartment floor: do not place accessories on the cooking compartment floor. Do not cover the cooking compartment floor with any sort of foil or greaseproof paper. Do not place ovenware on the cooking compartment floor if a temperature of over 50 °C has been set. This will cause heat to accumulate. The baking and roasting times will no longer be correct and the enamel will be damaged.
- Aluminium foil: Aluminium foil in the cooking compartment must not come into contact with the door glass. This could cause permanent discolouration of the door glass.
- Water in a hot cooking compartment: do not pour water into the cooking compartment when it is hot. This will cause steam. The temperature change can cause damage to the enamel.
- Moisture in the cooking compartment: Over an extended period of time, moisture in the cooking compartment may lead to corrosion. Allow the cooking compartment to dry after use. Do not keep moist food in the closed cooking compartment for extended periods of time. Do not store food in the cooking compartment.
- Cooling with the appliance door open: Following operation at high temperatures, only allow the cooking compartment to cool down with the door closed. Do not trap anything in the appliance door. Even if the door is only left open a crack, the front of nearby furniture may become damaged over time. Only leave the cooking compartment to dry with the door open if a lot of moisture was produced whilst the oven was operating.
- Fruit juice: when baking particularly juicy fruit pies, do not pack the baking tray too generously. Fruit juice dripping from the baking tray leaves stains that cannot be removed. If possible, use the deeper universal pan.
- Extremely dirty seal: If the seal is very dirty, the appliance door will no longer close properly during operation. The fronts of adjacent units could be damaged. Always keep the seal clean.
- Appliance door as a seat, shelf or worktop: Do not sit on the appliance door, or place or hang anything on it. Do not place any cookware or accessories on the appliance door.
- Inserting accessories: depending on the appliance model, accessories can scratch the door panel when closing the appliance door. Always insert the accessories into the cooking compartment as far as they will go.
- Carrying the appliance: do not carry or hold the appliance by the door handle. The door handle cannot support the weight of the appliance and could break.

## Steam

### Caution!

- Baking tins: Ovenware must be heat and steam resistant. Silicone baking tins are not suitable for combined operation with steam.
- Ovenware with areas of rust: Do not use any ovenware which displays areas of rust. Even the smallest spots of rust can lead to corrosion in the cooking compartment.
- Dripping liquids: When steaming with a perforated cooking container, always insert the baking tray, the universal pan or the solid cooking container underneath. Dripping liquid is caught.
- Hot water in the water tank: Hot water can damage the pump. Only fill the water tank with cold water.
- Enamel damage: Do not start any operations when there is water on the cooking compartment floor. Before operation, wipe away the water from the cooking compartment floor.
- Descaling solution: Do not allow descaling solution to come into contact with the control panel or other sensitive surfaces. These will damage the surfaces. If this does happen, remove the descaling solution immediately with water.
- Cleaning the water tank: Do not clean the water tank in the dishwasher. Otherwise, the water tank will be damaged. Clean the water tank with a soft cloth and standard washing-up liquid.

## Environmental protection

Your new appliance is particularly energy-efficient. Here you can find tips on how to save even more energy when using the appliance, and how to dispose of your appliance properly.

### Saving energy

- Only preheat the appliance if this is specified in the recipe or in the tables in the operating instructions.
- Use dark, black lacquered or enamelled baking tins. They absorb heat particularly well.
- Open the appliance door as infrequently as possible during operation.
- It is best to bake several cakes one after the other. The cooking compartment is still warm. This reduces the baking time for the second cake. You can place two cake tins next to each other in the cooking compartment.
- For longer cooking times, you can switch the appliance off 10 minutes before the end of the cooking time and use the residual heat to finish cooking.

### Environmentally-friendly disposal

Dispose of packaging in an environmentally-friendly manner.



This appliance is labelled in accordance with European Directive 2012/19/EU concerning used electrical and electronic appliances (waste electrical and electronic equipment - WEEE). The guideline determines the framework for the return and recycling of used appliances as applicable throughout the EU.

## Getting to know your appliance

In this chapter, we will explain the displays and controls. You will also find out about the various functions of your appliance.

**Note:** Depending on the appliance model, individual details and colours may differ.

## Control panel

In the control panel, you can use the various buttons and the rotary selector to set the required function of the appliance. The current settings are shown on the display.



### 1 Buttons

The buttons to the left and right of the rotary selector have a pressure point. Press these buttons to activate them.

### 2 Rotary selector

You can turn the rotary selector clockwise and anti-clockwise.

### 3 Touch display

You can see the current adjustment values, options or notes in the touch display. To implement settings, touch the appropriate text field. The text fields change depending on the selection.

»»»»	Rapid heat up	Switches rapid heat up on and off
☐	Open cover	Filling or emptying the water tank → "Filling the water tank" on page 18
Start/Stop		Starts, pauses or cancels operation

## Rotary selector

Use the rotary selector to change the adjustment values shown in the display.

In most selection lists, e.g. types of heating, the first selection follows the last. For temperature, for example, you must turn the rotary selector back when the minimum or maximum temperature is reached.

## Display

The display is structured so that the information can be read at a glance.

The value that you can currently set is in focus. It is displayed in white lettering with a dark background.

## Status bar

The status bar is at the top of the display. The time and set time functions are displayed here.

## Progress line

The progress line shows you how much the oven has already heated up or how much time has elapsed, for example. The straight line below the in-focus value

## Controls

The individual controls are adapted for the various functions of your appliance. You can set your appliance simply and directly.

### Buttons

Here you can find a short explanation of the various buttons.

Buttons		Meaning
on/off		Switches the appliance on and off
menu	Menu	Opens the operating modes menu
i	Information	Displays notes
	Childproof lock	Activates/deactivates the childproof lock
⌚	Time-setting options	Opens the time-setting options menu



progresses from left to right, the longer the operation continues to run.

### Countdown

If you have started your appliance without a cooking time, you can see how long the operation has already been running for at the top right in the status bar.

If you had set a cooking time and it was deleted, the countdown applies the time that has already elapsed and continues to count down from this time. You can therefore always check how long the operation has already been running.

### Temperature indicator







The temperature indicator bars show the heating phases or residual heat in the cooking compartment.

Heating indicator	The heating indicator displays the rising temperature in the cooking compartment. When all bars are filled, the optimum time for placing the dish in the oven has been reached. The bars do not appear when settings are applied for grilling and cleaning.
Residual heat indicator	When the appliance is switched off, the temperature indicator shows the residual heat in the cooking compartment. Once the temperature has dropped to approximately 60 °C, the display goes out.

**Note:** Due to thermal inertia, the temperature displayed may be slightly different to the actual temperature inside the oven. You can use the  button to check the current heating temperature when heating up.

### Types of heating

In order for you to find the correct type of heating for your dish, we have explained the differences and scopes of application here.







Types of heating	Temperature	Use
 4D hot air *	30-250 °C	For baking and roasting on one or more levels. The fan distributes the heat from the ring heating element in the back panel evenly around the cooking compartment.
 Top/bottom heating *	30-250 °C	For traditional baking and roasting on one level. Especially suitable for cakes with moist toppings. Heat is emitted evenly from the top and bottom.
 Hot air eco	30-250 °C	For gentle cooking of selected dishes on one level without preheating. The fan distributes the heat from the ring heating element in the back panel around the cooking compartment.
 Top/bottom heating eco	30-250 °C	For gentle cooking of selected dishes. The heat is emitted from above and below.
 Hot air grilling *	30-250 °C	For roasting poultry, whole fish and larger pieces of meat. The grill element and the fan switch on and off alternately. The fan circulates the hot air around the food.
 Grill, large area	Grill settings: 1 = low 2 = medium 3 = high	For grilling flat items such as steaks, sausages or bread, and for browning food. The whole area of the grill heating element becomes hot.

### Operating modes menu

The menu is divided into different operating modes. In this way, you can quickly access the required function.

Depending on the appliance type, there are a various number of operating modes. In the status bar at the top right, you can see how many pages there are in the operating modes menu. If 1/2 is displayed in the status bar, then you are on the first page of two pages.

Operating mode	Use
Types of heating	There are several finely tuned types of heating for you to prepare your dishes.
Steaming → "Steam" on page 16	There are finely tuned steam types of heating for you to prepare your dishes.
Dishes → "Dishes" on page 32	Here you can find preprogrammed setting values which are suitable for many dishes.
Cleaning function → "Cleaning function" on page 23	The cleaning function cleans your oven almost automatically.
Descal → "Cleaning function" on page 23	You can use this to remove limescale from the evaporator.
Drying → "Steam" on page 16	Use after every operation with steam.
Settings → "Basic settings" on page 22	You can adapt your appliance's basic settings to suit your needs.

	Grill, small area	Grill settings: 1 = low 2 = medium 3 = high	For grilling small quantities of food such as steaks, sausages or bread, and for browning food. The centre part under the grill heating element becomes hot.
	Pizza setting	30-250 °C	For preparing pizza and dishes which require a lot of heat from underneath. The bottom heating element and the ring heating element in the back panel heat up.
	Slow cooking	70-120 °C	For gentle and slow cooking of seared, tender pieces of meat in ovenware without a lid. The heat is emitted evenly from the top and bottom at low temperatures.
	Bottom heating	30-250 °C	For cooking in a bain marie and for the final baking stage. The heat is emitted from below.
	CoolStart function	30-250 °C	For the quick preparation of frozen products on level 1. The temperature depends on the manufacturer's instructions. Use the highest temperature specified on the packaging. The cooking time is as specified, or shorter. Preheating is not productive.
	Keeping warm *	60-100 °C	For keeping cooked food warm.
	Preheating ovenware	30-70 °C	For preheating ovenware.





\* Possible to use steam for this type of heating (operation only possible when the water tank is full)

### Default values

For each type of heating, the appliance specifies a default temperature or level. You can accept this value or change it in the appropriate area.

### Steam

To enable you to find the correct steam type of heating for your dish, we have explained the differences and scopes of application here.

Type of heating	Temperature	Use
 Steaming	30-100 °C	For vegetables, fish, side dishes, for juicing fruit and for blanching
 Reheating	80-180 °C	For gently heating food up and for crisping up pastries. The steam ensures that the food does not dry out.
 Dough proving	30-50 °C	For leaving yeast dough and sourdough to prove and for culturing yogurt. Dough will prove more quickly than at room temperature. The surface of the dough does not dry out.
 Defrosting	30-60 °C	For vegetables, meat, fish and fruit The moisture gently transfers the heat to the food. The food does not dry out or lose its shape

### Further information

In most cases, the appliance provides notes and further information on the action just carried out. To do this, press the  button. The note is shown for a few seconds.

Some notes are displayed automatically, for example as confirmation, or to provide an instruction or warning.

### Cooking compartment functions

Some functions make your appliance easier to use. This, for example, enables the cooking compartment to be well lit and a cooling fan to prevent the appliance from overheating.

#### Opening the appliance door

If you open the appliance door during an operation, the operation is paused. Operation continues to run when you close the door.

## Interior lighting

When you open the appliance door, the interior lighting switches on. If the door remains open for longer than 15 minutes, the lighting switches off again.

For most operating modes, the interior lighting switches on as soon as the operation is started. When the operation has finished, the lighting switches off.

**Note:** You can set the interior lighting not to come on during the operation in the basic settings.

## Cooling fan

The cooling fan switches on and off as required. The hot air escapes above the door.

### Caution!

Do not cover the ventilation slots. Otherwise the oven will overheat.

So that the cooking compartment cools down more quickly after operation, the cooling fan continues to run for a certain period afterwards.

**Note:** You can change how long the cooling fan continues to run for in the basic settings. → "Basic settings" on page 22

## Water tank

The appliance is fitted with a water tank. The water tank is behind the panel. For operations with steam, fill the water tank with water. → "Steam" on page 16

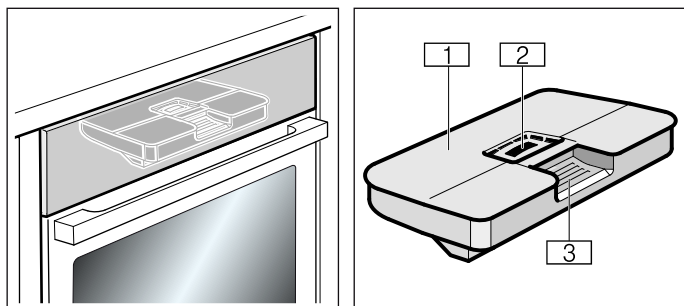



- 1 Tank cover
- 2 Filling opening
- 3 Handle for removing and inserting the water tank

## Accessories

Your appliance is accompanied by a range of accessories. Here, you can find an overview of the accessories included and information on how to use them correctly.

### Accessories included

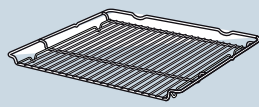
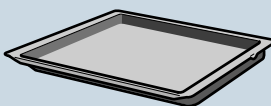
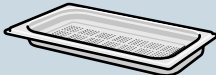
Your appliance is equipped with the following accessories:

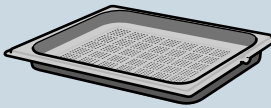
	<p><b>Wire rack</b> For ovenware, cake tins and ovenproof dishes. For roasts, grilled items and frozen meals.</p>
	<p><b>Universal pan</b> For moist cakes, other baked items, frozen meals and large roasts. It can be used to catch dripping fat when you are grilling directly on the wire rack. During operation with steam, it can also be used to catch drops of water.</p>
	<p><b>Steam container, perforated, size S</b> For steaming vegetables, juicing berries and defrosting.</p>
	<p><b>Steam container, unperforated, size S</b> For cooking rice, pulses and cereals.</p>
	<p><b>Steam container, perforated, size XL</b> For steaming large quantities.</p>

Only use genuine accessories. They are specially adapted for your appliance.

You can buy accessories from the after-sales service, from specialist retailers or online.

**Note:** The accessories may become deformed when they become hot. This does not affect their function. Once they cool down again, they regain their original shape.

**Note:** You can use the steam container with all heating modes involving steam without any restrictions. If you set other heating modes at high temperatures, take the steam container out of the cooking compartment. High temperatures can cause permanent deformations and discolouration of the steam container.

## Inserting accessories

The cooking compartment has three shelf positions. The shelf positions are counted from the bottom up.

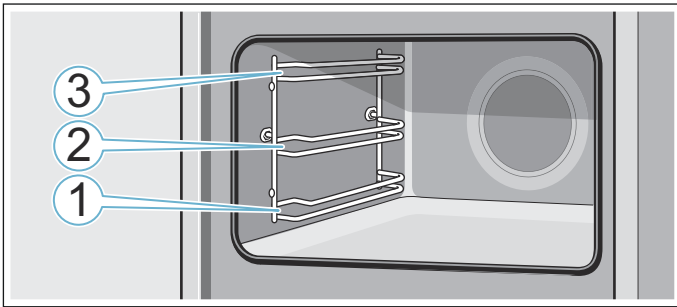

Always insert the accessory between the two guide rods for a shelf position.

The accessories can be pulled out approximately halfway without tipping.

### Notes

- Ensure that you always insert the accessories into the cooking compartment the right way round.
- Always insert the accessories fully into the cooking compartment so that they do not touch the appliance door.

### Locking function

The accessories can be pulled out approximately halfway until they lock in place. The locking function prevents the accessories from tilting when they are pulled out. The accessories must be inserted into the cooking compartment correctly for the tilt protection to work properly.

When inserting the wire rack, ensure that lug **a** is at the rear and is facing downwards. The open side must be facing the appliance door and the outer rail must be facing downwards.

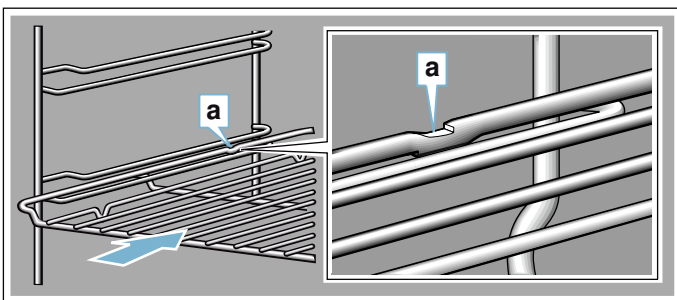

When inserting baking trays, ensure that lug **a** is at the rear and is facing downwards. The sloping edge of the accessory **b** must be facing towards the appliance door.

Example in the picture: Universal pan

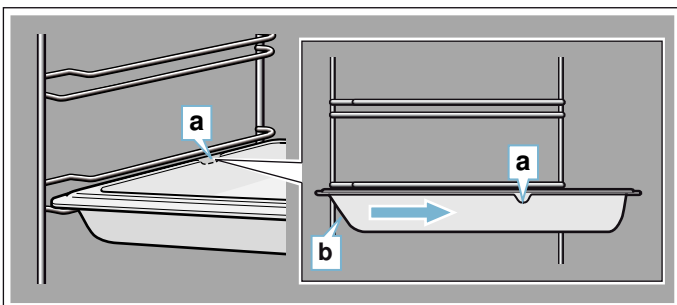

## Combining accessories

You can insert the wire rack and the universal pan at the same time to catch drops of liquid.

When inserting the wire rack, ensure that both spacers **a** are at the rear edge. When inserting the universal pan, the wire rack is on top of the upper guide rod of the shelf position.

Example in the picture: Universal pan

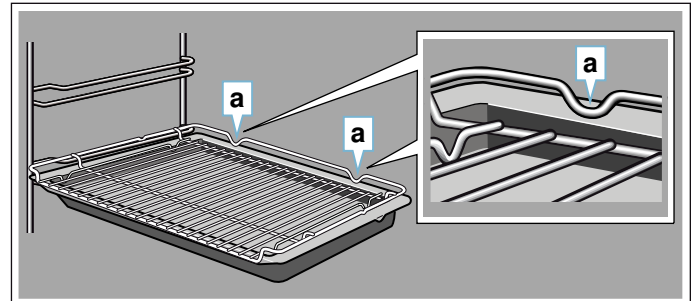

Small steam containers may only be placed in the cooking compartment with the wire rack.

## Optional accessories

You can buy optional accessories from the after-sales service, from specialist retailers or online. \*You will find a comprehensive range of products for your appliance in our brochures and online.

Both availability and whether it is possible to order online differ between countries. Please see your sales brochures for more details.

**Note:** Not all optional accessories are suitable for every appliance. When purchasing, please always quote the exact identification number (E-no.) of your appliance. → "Customer service" on page 31

### Special accessories

#### Wire rack

For ovenware, cake tins and ovenproof dishes, and for roasts and grilled food.

#### Universal pan

For moist cakes, pastries, frozen meals and large roasts. It can be used to catch dripping fat when you are grilling directly on the wire rack.

#### Baking tray

For tray bakes and small baked products.

#### Wire insert

For meat, poultry and fish. For inserting into the universal pan to catch dripping fat and meat juices.

#### Universal pan, non-stick

For moist cakes, pastries, frozen meals and large roasts. Pastries and roasts can be removed more easily from the universal pan.

#### Baking tray, non-stick

For tray bakes and small baked products. The pastries can be removed more easily from the baking tray.

<b>Profi pan</b>
For preparing large quantities.
<b>Lid for the Profi pan</b>
The lid turns the Profi pan into a Profi roasting dish.
<b>Pizza tray</b>
For pizzas and large round cakes.
<b>Grill tray</b>
Use for grilling in place of the wire rack or as a splatter guard. Only use in the universal pan.
<b>Bread-baking stone</b>
For home-made bread, bread rolls and pizzas that require a crispy base. The baking stone must be preheated to the recommended temperature.
<b>Glass roasting dish (5.1 litres)</b>
For stews and bakes. Particularly suitable for the "Meals" operating mode.
<b>Glass tray</b>
For large roasts, moist cakes and bakes.
<b>Steam container, perforated, size XL</b>
For steaming large quantities.
<b>Steam container, perforated, size S</b>
For steaming vegetables, juicing berries and defrosting.
<b>Steam container, solid, size S</b>
For cooking rice, pulses and cereals.
<b>Porcelain cooking container, solid, size S</b>
For steaming and serving meat, fish and vegetables.
<b>Porcelain cooking container, solid, size L</b>
For steaming and serving meat, fish and vegetables.
<b>Pull-out system, 1 level</b>
The pull-out rails at level 1 allow you to pull the accessories out further without them tipping.
<b>Decorative trims</b>
For concealing the lower shelf of the unit and the base of the appliance.

## Before using for the first time

Before you can use your new appliance, you must make some settings. You must also clean the cooking compartment and accessories.

### Before using for the first time

Before using the appliance for the first time, enquire about the water hardness of your tap water from your water supplier.

So that the appliance can reliably remind you to decalcify it when required, you must correctly set your water hardness range.

#### Caution!

The appliance may become damaged due to the use of unsuitable liquids.

Do not use distilled water, highly chlorinated tap water (>40 mg/l) or other liquids.

Only use cold, fresh tap water, softened water or non-carbonated mineral water.

#### Notes

- If your water is very hard, we recommend that you use softened water.
- If you only use softened water, you can set the water hardness range to "softened" in this case.
- If you use mineral water, set the water hardness range to "4 very hard".
- If you use mineral water, you must only use non-carbonated mineral water.

Water hardness range	Setting
0	0 softened
1 (up to 1.3 mmol/l)	1 soft
2 (1.3 - 2.5 mmol/l)	2 medium
3 (2.5 - 3.8 mmol/l)	3 hard
4 (above 3.8 mmol/l)	4 very hard

### Initial use

After connecting the appliance to the power or following a power cut, the settings for initial use are shown in the display.

**Note:** You can change these settings at any time in the basic settings. → "Basic settings" on page 22

### Setting the language

German is the preset language.

1. Use the rotary selector to select the required language.
2. Touch the > arrow.  
The next setting appears.

en Before using for the first time

### Setting the time

The time starts at 12:00.

1. Use the rotary selector to set the current time.
2. Touch the > arrow

### Setting the date

The default date is 1.1.2014.

1. Always touch the > arrow to move to the next setting.
2. Use the rotary selector to set the current day, month and year.

### Setting the water hardness

The default water hardness setting is "very hard".

1. Set the hardness using the rotary selector.
2. Touch the > arrow.  
A note appears on the display confirming that the initial use has been completed.

### Calibrating the appliance and cleaning the cooking compartment

The boiling point of water depends on the air pressure. During calibration, the appliance sets itself to the pressure ratio at the installation location. This occurs automatically during the first steam operation. This results in a lot of steam.

#### Preparing the calibration

1. Remove the accessories from the cooking compartment.
2. Remove leftover packaging, such as polystyrene pellets, from the cooking compartment.
3. Before calibrating the appliance, wipe the smooth surfaces in the cooking compartment with a soft, wet cloth.

#### Calibrating the appliance and cleaning the cooking compartment

##### Notes

- The calibration can only be started once the cooking compartment is cold (room temperature).
- Do not open the appliance door during calibration. Calibration will otherwise be interrupted.

1. Press the On/Off button to switch on the appliance.
2. Fill the water tank. → "Filling the water tank" on page 18
3. Set the specified type of heating, temperature and duration for the calibration, then start the appliance operation. → "FullSteam – Steam cooking" on page 16

Calibration	
Type of heating	Steam 
Temperature	100 °C
Duration	30 minutes

4. After calibration, allow the appliance to heat up.

### Caution! Enamel damage

Do not start an operation if water is on the cooking compartment floor. Before the operation, wipe the water from the cooking compartment floor.

5. Dry the cooking compartment floor.
6. Set the type of heating and temperature for heating up, then start the appliance operation.

Heating up	
Type of heating	Top/bottom heating 
Temperature	240 °C
Duration	30 minutes

7. Keep the kitchen ventilated while the appliance is heating up.
8. Stop the appliance operation after the indicated duration. Press the On/Off button to switch off the appliance.
9. Wait until the cooking compartment has cooled down.
10. Clean the smooth surfaces with soapy water and a dish cloth.
11. Empty the water tank and dry the cooking compartment. → "After every steam operation" on page 19

##### Notes

- So that the appliance adapts to a new installation location after moving house, reset the appliance to the factory settings. Repeat the initial use settings and the calibration.
- The appliance saves the calibration settings, even in the event of a power cut or disconnection from the mains. The calibration must not be repeated.

### Cleaning the accessories

Clean the accessories thoroughly using soapy water and a dish cloth or soft brush.

## Operating the appliance

You have already learnt about the controls and how they work. Now we will explain how to set your appliance. You will learn about what happens when you switch the appliance on and off, and how to select the operating mode.

### Switching the appliance on and off

Before you are able to set the appliance, you must switch it on.

Exception: The childproof lock and the timer can be set when the appliance is switched off.

Displays or information, e.g the residual heat indicator in the cooking compartment, remain visible in the display after the appliance has been switched off.

Switch off your appliance when you do not need to use it. If no settings are applied for a long time, the appliance switches itself off automatically.

### Switching the appliance on

Use the On/Off button to switch the appliance on. The on/off symbol above the button is illuminated in blue.

The Siemens logo appears in the display, and then a type of heating and a temperature.

**Note:** You can specify which operating modes should appear after the appliance is switched on in the basic settings.

### Switching off the appliance

Use the On/Off button to switch off the appliance. The lighting above the button goes out.

A set function is cancelled.

The time appears in the display.

**Note:** You can set whether or not the time should be displayed when the appliance is switched off in the basic settings.

### Starting or interrupting operation

To start operation or to interrupt an operation which has started running, press the Start/Stop button. The cooling fan may continue to run after an operation is interrupted.

Press the On/Off button to delete all settings.

If you open the cooking compartment door during operation, operation is interrupted. Close the cooking compartment door to continue operation.

## Selecting an operating mode

When you select an operating mode, the appliance must be switched on.

1. Press the menu button.  
The operating modes menu opens.
2. Touch the required operating mode.  
Depending on the operating mode, different options are available.
3. Use the rotary selector to change the selection.  
Depending on the selection, change further settings.
4. Use the start/stop button to start.  
The elapsed time appears in the display. The settings and progress line can be seen.

## Setting the type of heating and temperature

After the appliance is switched on, the set suggested type of heating appears with the temperature. You can start this setting immediately with the Start/Stop button. If you want to set another type of heating, proceed as follows.

For other settings, you can change the values as follows:

Example in the picture: Top/bottom heating at 180 °C.

1. Use the rotary selector to change the type of heating.

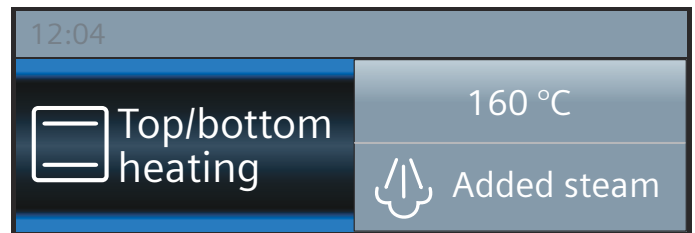

2. Touch the suggested temperature.
3. Use the rotary selector to change the temperature.

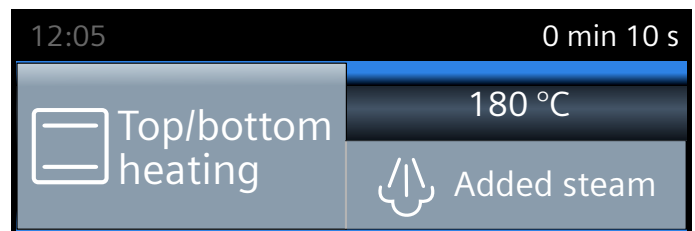

4. Press the Start/Stop button to start.

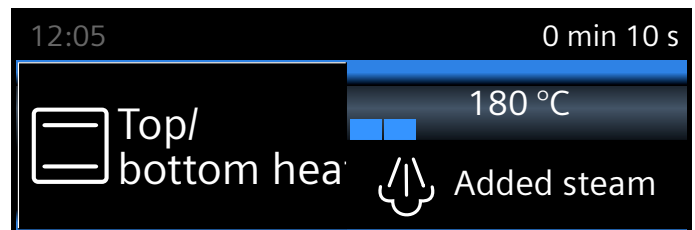



The set type of heating and the temperature are shown on the display.

## Rapid heat up

You can use the »||| button to heat up the cooking compartment particularly quickly. The rapid heat up function is not possible for all types of heating.

Suitable types of heating:

	4D hot air
	Top/bottom heating

To ensure an even cooking result, do not place your food and the accessory in the cooking compartment until rapid heating is complete.

### Making settings

Ensure you have selected a suitable type of heating. The temperature must be set to above 100 °C, otherwise the rapid heating function cannot be started.

1. Set the type of heating and temperature.
2. Press the »||| button.

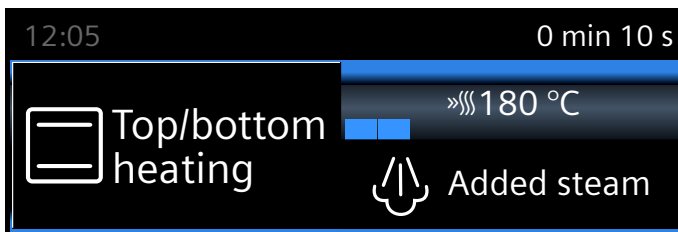

The »||| symbol appears on the left next to the temperature. The temperature indicator starts to fill in.

When rapid heating is complete, a signal sounds. The »||| symbol goes out. Place your dish in the cooking compartment.

### Notes

- If you change the type of heating or the temperature, the rapid heating function is cancelled.
- If a duration has been set, this runs independently of rapid heating and counts down immediately when the operation is started.
- You can use the  button to check the current cooking compartment temperature during rapid heating.

### Cancelling

Press the »||| button. The »||| symbol disappears from the display.

## Steam

Food can be cooked particularly gently using steam. With some types of heating, you can prepare food with steam assistance. In addition, the Dough proving, Reheating and Defrosting types of heating are available.

### Warning – Risk of scalding!

When you open the appliance door, hot steam can escape. Steam may not be visible, depending on its temperature. When opening, do not stand too close to the appliance. Open the appliance door carefully. Keep children away.

### Noise

#### Pump

You will hear a humming noise while the pump is in operation and after switching it off. This noise is caused by the pump function test. It is a normal operating noise.

#### Control panel

You will hear a humming or clicking noise when opening the control panel. These noises are caused by the control panel being pushed out. They are normal operating noises.

### FullSteam – Steam cooking

During steaming, hot steam surrounds the food and therefore prevents loss of nutrients from the food. The shape, colour and typical aroma of the dishes are retained as a result of this preparation method.

**Note:** If the water tank runs dry during steaming, operation is interrupted. Fill the water tank.

### Starting

1. Fill the water tank.
  - Note:** Only switch on steaming once the cooking compartment has cooled down completely (to room temperature).
2. Press the Menu button.
3. Touch the "Steam" field.
4. Use the rotary selector to set "Steam .
5. Touch the "Temperature" field and set the temperature using the rotary selector.
6. Touch the "Cooking time" field and set the cooking time using the rotary selector.
7. Press the Start/Stop button to start.
  - The appliance heats up. Once the appliance has heated up, an audible signal sounds and the operation begins.

An audible signal sounds. The oven stops heating. You can cancel the audible signal early using the  button.

### Cancelling

Touch the Start/Stop button to cancel the operation.

### Finishing

Touch the On/Off button to switch off the appliance.



## Menu cooking

With steam, you can cook a whole menu at once, without the different flavours mixing. → *"Tested for you in our cooking studio" on page 33*

## Steam-assisted cooking

When you cook with steam assistance, steam is introduced into the cooking compartment at various intervals and with varying degrees of intensity. This gives you a better cooking result.

Your food

- Becomes crispy on the outside
- Develops a shiny surface
- Is succulent and tender on the inside
- Only undergoes a minimum reduction in volume

You set the type of heating and steam intensity combination that you want. Use the information in the tables to select a suitable type of heating and steam intensity, or select a programme.





### Steam intensity

Different intensity levels are available when adding steam:

- Low
- Medium
- High

### Suitable types of heating

You can switch on steam assistance for these types of heating:

- 4D hot air 
- Top/bottom heating 
- Hot air grilling 
- Keeping warm 

### Starting

1. Fill the water tank.
2. Set the type of heating using the rotary selector.
3. Touch the "Temperature" field and set the temperature using the rotary selector.
4. Touch the "Added steam" field and set the steam intensity using the rotary selector.
5. Press the Start/Stop button to start.  
The appliance heats up.

**Note:** If the water tank runs dry during a steam operation, a message appears on the display prompting you to fill up the water tank. The operation continues without adding steam.

### Cancelling steam addition

To switch off steam assistance early, touch the "Added steam" field. Use the rotary selector to set to "Off".

**Note:** The operation continues without adding steam.

### Cancelling appliance operation

Touch the Start/Stop button to cancel the operation.

### Finishing

Touch the On/Off button to switch off the appliance.

## Reheating

With the "Reheating 

 type of heating, you can gently reheat food that has already been cooked or crisp up day-old baked goods. Steam is switched on automatically.

**Note:** If the water tank runs dry during the operation with the Reheating setting, the operation is interrupted. Fill the water tank.

### Starting

1. Fill the water tank.
2. Touch the Menu button.
3. Touch the "Steaming" field.
4. Use the rotary selector to set to "Reheating ".
5. Touch the "Temperature" field and set the temperature using the rotary selector.
6. Touch the "Duration" field and set the duration using the rotary selector.
7. Press the Start/Stop button to start.  
The appliance heats up.

A signal sounds. The oven stops heating. You can cancel the audible signal early using the  button.

### Cancelling

Touch the Start/Stop button to cancel the operation.

### Finishing

Touch the On/Off button to switch off the appliance.

## Prove dough

Dough will prove considerably more quickly using the "Dough proving 

 type of heating than at room temperature and does not dry out.

Use the information in the tables to select the appropriate setting. → *"Tested for you in our cooking studio" on page 33*

**Note:** If the water tank runs dry during the operation with the Dough proving setting, the operation is interrupted. Fill the water tank.

### Starting

1. Fill the water tank.  
**Note:** Only switch on Dough proving once the cooking compartment has completely cooled down (to room temperature).
2. Touch the Menu button.
3. Touch the "Steaming" field.
4. Use the rotary selector to set to "Dough proving ".
5. Touch the "Temperature" field and set the temperature using the rotary selector.
6. Touch the "Duration" field and set the duration using the rotary selector.
7. Press the Start/Stop button to start.  
The appliance heats up.

A signal sounds. The oven stops heating. You can cancel the audible signal early using the  button.

### Cancelling

Touch the Start/Stop button to cancel the operation.

## Finishing

Touch the On/Off button to switch off the appliance.

## Defrosting

Use the "Defrosting " type of heating to defrost frozen products.

**Note:** If the water tank runs dry during the operation with the Defrosting setting, the operation is interrupted. Fill the water tank.

## Starting

1. Fill the water tank.
2. Touch the Menu field.
3. Touch the "Steaming" field.
4. Use the rotary selector to set to "Defrosting ".
5. Touch the "Temperature" field and set the temperature using the rotary selector.
6. Touch the "Duration" field and set the duration using the rotary selector.
7. Press the Start/Stop button to start.  
The appliance heats up. Once the appliance has heated up, an audible signal sounds and the operation begins.

Once the duration has elapsed, an audible signal sounds. The appliance stops heating. The duration 00 m 00 s is shown in the display.

## Cancelling

Touch the Start/Stop button to cancel the operation.

## Finishing

Touch the On/Off button to switch off the appliance.

## Filling the water tank

The water tank is located behind the control panel. Before starting an operation with steam, open the control panel and fill the water tank with water.

Make sure that you have set the water hardness range correctly. → "Basic settings" on page 22

### **Warning – Risk of injury and risk of fire!**

Only fill the water tank with water or with the descaling solution that is recommended by us. Do not pour any flammable liquids (e.g. alcoholic drinks) into the water tank. Due to hot surfaces, vapours from flammable liquids may catch fire in the cooking compartment (explosion). The appliance door may spring open. Hot steam and jets of flame may escape.

### **Warning – Risk of burns!**

The water tank may heat up while the appliance is in operation. Wait until the water tank has cooled down after the previous appliance operation. Remove the water tank from the water tank recess.

## Caution!

The appliance may become damaged due to the use of unsuitable liquids.

Do not use distilled water, highly chlorinated tap water (> 40 mg/l) or other liquids.

Only use cold, fresh tap water, softened water or uncarbonated mineral water.

1. Touch the  field.  
The control panel is automatically pushed forwards.
2. Pull the control panel forwards with both hands and then push it upwards until it locks into place (Fig. **1**).
3. Lift the water tank and remove it from the water tank recess (Fig. **2**).

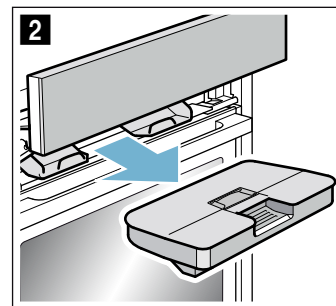
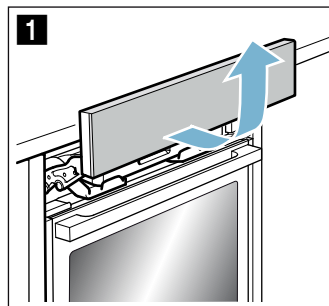

4. Press down on the lid along the seal to prevent water from leaking out of the water tank.
5. Remove the cover **a** (Fig. **3**).
6. Fill the water tank with cold water up to the "max." mark (Fig. **4**).

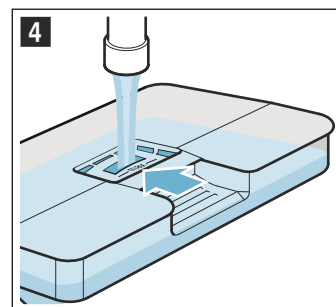
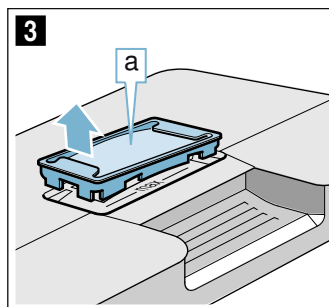

7. Reinsert the cover **a** into the opening in the water tank.
8. Insert the filled water tank (Fig. **5**). Ensure that the water tank locks into place behind both holders **b** (Fig. **6**).

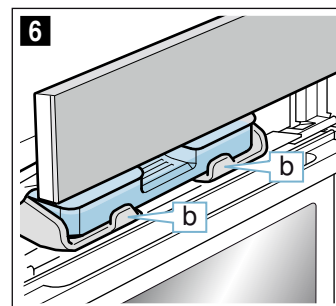
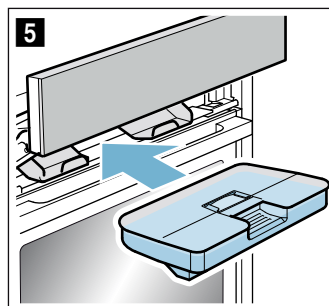

9. Slowly push the control panel downwards and then towards the rear until it is closed completely. The water tank has been filled. You can start operations with steam.

## Refilling the water tank

If the water tank runs dry during a steam operation, a message appears on the display prompting you to fill up the water tank.

### Notes

- Steam-assisted operations continue without adding steam.
- If the water tank runs dry during the operation with the Steaming, Dough proving, Reheating or Defrosting settings, the operation is interrupted. Fill the water tank.

1. Open the control panel.
2. Remove and refill the water tank.
3. Insert the filled water tank and close the control panel.

## After every steam operation

### ⚠ Warning – Risk of scalding!

When you open the appliance door, hot steam can escape. Steam may not be visible, depending on its temperature. When opening, do not stand too close to the appliance. Open the appliance door carefully. Keep children away.

### ⚠ Warning – Risk of burns!

The appliance becomes hot during operation. Allow the appliance to cool down before cleaning.

### Caution!

Enamel damage: Do not start any operations when there is water on the cooking compartment floor. Before operation, wipe away the water from the cooking compartment floor.

The remaining water is pumped back into the water tank after every operation with steam. Then empty and dry the water tank. Moisture remains in the cooking compartment. To dry the cooking compartment, you can either use the "Drying function" operating mode or dry the cooking compartment by hand.

### Notes

- Once the appliance has been switched off, the  field remains lit for a little longer to remind you to empty the water tank.
- Remove limescale marks with a cloth soaked in vinegar, then wipe with clean water and dry with a soft cloth.

## Emptying the water tank

### Caution!

- Do not dry the water tank in the hot cooking compartment. This will damage the water tank.
- Do not clean the water tank in the dishwasher. This will damage the water tank.

1. Open the control panel.
2. Remove water tank.
3. Carefully remove the lid of the water tank.
4. Empty the water tank, clean it with detergent and then rinse it thoroughly with clean water.
5. Dry all parts with a soft cloth.
6. Rub the seal on the lid until dry.

7. Leave to dry with the lid open.
8. Place the lid on the water tank and push it down.
9. Insert the water tank and close the control panel.

## Cleaning the drip trough

1. Allow the appliance to cool down.
2. Open the appliance door.
3. Wipe around the drip trough **a** underneath the cooking compartment with a sponge cloth (fig. **1**).

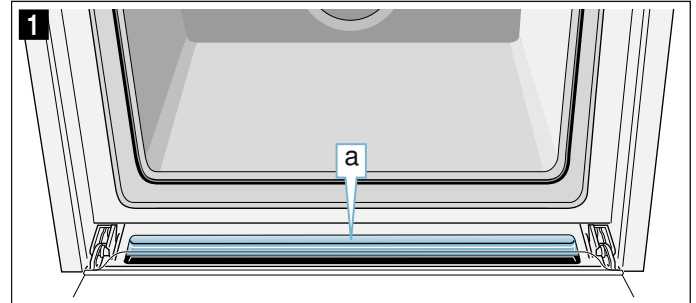

## Starting the Drying function

During drying, the cooking compartment is heated up so that the moisture in the cooking compartment evaporates. Then open the appliance door so that the steam escapes.

### Caution!

Enamel damage: Do not start any operations when there is water on the cooking compartment floor. Before operation, wipe away the water from the cooking compartment floor.



1. Leave the appliance to cool down.
2. Remove the worst dirt from the cooking compartment immediately and wipe away moisture from the cooking compartment floor.
3. If necessary, press the On/Off button to switch on the appliance.
4. Press the menu button. The options for selecting an operating mode are displayed.
5. Touch the "Next" field.
6. Touch the "Drying" field.
7. Press the Start/Stop button. The drying function starts and ends automatically after 10 minutes.
8. Open the appliance door and leave it open for 1 to 2 minutes so that the moisture in the cooking compartment can escape.

## Drying the cooking compartment by hand

1. Leave the appliance to cool down.
2. Remove any dirt from the cooking compartment.
3. Dry the cooking compartment with a soft cloth.
4. Leave the appliance door open for one hour so that the cooking compartment dries completely.

## Time-setting options

Your appliance has different time-setting options.

Time-setting option	Use
 Timer	The timer functions like an egg timer. An audible signal sounds once the set time has elapsed.
 Cooking time	A signal sounds once a set cooking time has elapsed. The appliance switches off automatically.
 End	Set a cooking time and an end time. The appliance switches on automatically so that the operation ends at the desired time.



### Notes

- A cooking time of up to one hour can be set exactly to the minute.  
A cooking time of over one hour can be set in 5-minute increments.
- Depending on which direction you turn the rotary selector, the cooking time starts at a default value:  
Anti-clockwise, 10 minutes,  
Clockwise, 30 minutes.
- After a time-setting option has elapsed, a signal sounds.
- Using the  button, you can request information during operation, which then appears briefly in the display.

### Timer

You can set the timer at any time, even if the appliance is switched off. It runs parallel to the other time settings and has a separate audible signal. In this way, you can tell whether it is the timer or a cooking time which has elapsed.



The maximum setting you can apply is 24 hours.

1. Press the  button.  
The field for the timer opens.
  2. Use the rotary selector to set the timer duration.  
The timer starts after a few seconds.
- The  symbol for the timer and the time counting down are displayed on the left in the status bar.



### When the time has elapsed

An audible signal sounds. "Timer elapsed" appears in the display. Use the  button to cancel the audible signal early.

### Cancelling the timer duration

Press the  button to open the time-setting options menu and turn the time back. Press the  button to close the menu.

### Changing the timer duration

Use the  button to open the time-setting options menu and change the timer time in the next few seconds using the rotary selector. Start the timer with the  button.

### Cooking time

If you set the cooking time for your meal, the operation stops automatically once this time has elapsed. The oven stops heating.

Prerequisite: A type of heating and a temperature have been set.

For example: Setting for 4D hot air, 180 °C, cooking time 45 minutes.

1. Press the  button.  
The time-setting options menu opens.

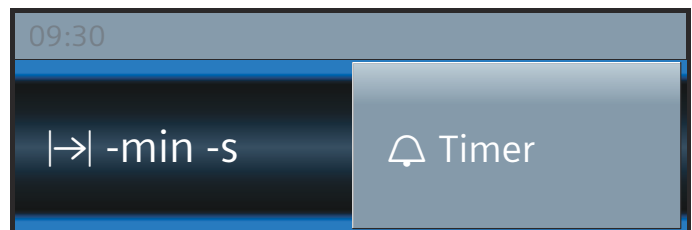

2. Set the cooking time using the rotary selector.

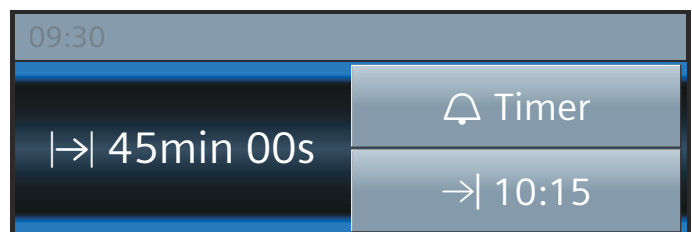

3. Press the Start/Stop button to start.  
You can see the I->| cooking time counting down in the status bar.

### The cooking time has elapsed

A signal sounds. The oven stops heating. "Finished" appears in the status bar. You can cancel the audible signal early using the  button.

### Cancelling the cooking time

Press the  button to open the time-setting options menu. Turn the time back. The type of heating and temperature set are shown in the display.

### Changing the cooking time

Press the  button to open the time-setting options menu. Change the cooking time using the rotary selector.

### End time

If you change the end time, please remember that easily spoiled foods must not be allowed to remain in the cooking compartment for too long.

Prerequisite: The selected operation has not already begun. A cooking time has been set. The time-setting options menu  is open.

Example in the picture: You put the dish in the cooking compartment at 9:30. It takes 45 minutes to cook and will be ready at 10:15, but you would like it to be ready at 12:45 instead.

1. Touch the "End →" field.  
The end time is displayed.

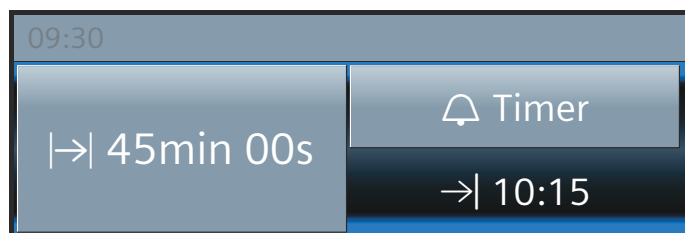

2. Using the rotary selector, set a later end time.

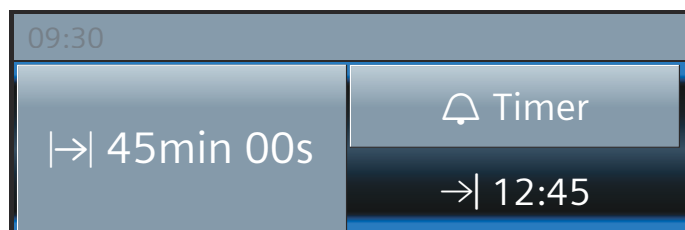

3. Confirm with the Start/Stop button.

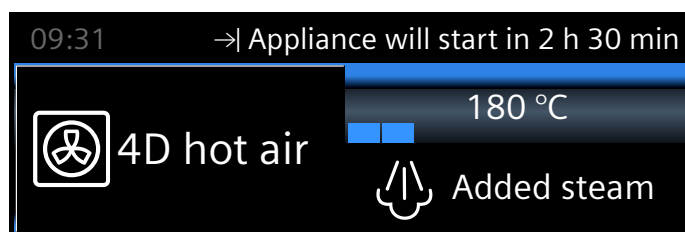

The oven is in standby. The → symbol and the time when the operation will be finished appear in the status bar. The operation starts at the appropriate time. You can see the cooking time counting down in the status bar.

### The cooking time has elapsed

A signal sounds. The oven stops heating. "Finished" appears in the status bar. You can cancel the audible signal early using the ⏸ button.

### Correcting the end time

This is possible if the oven is in standby. Use the ⏸ button to open the time-setting options menu, touch "End →" and use the rotary selector to correct the end time. Press the ⏸ button to close the menu.

### Cancelling the end time

This is possible if the oven is on standby. To do so, open the time-setting options menu using the ⏸ button. Touch "End →" and reset the End time using the rotary selector. The cooking time immediately starts to count down.

## Childproof lock

Your appliance is equipped with a childproof lock so that children cannot switch it on accidentally or change any settings.

The control panel is locked and no settings can be made. The appliance can only be switched off using the on/off button.

### Activating and deactivating

You can activate and deactivate the childproof lock when the appliance is switched on or off.

In each case, press the 🔒 button for approx. 4 seconds. A confirmation note appears in the display and the 🔒 symbol appears in the status bar.

## Basic settings

There are various settings available to you in order to help use your appliance effectively and simply. You can change these settings as required.

### Changing settings

1. Press the On/Off button.
2. Press the menu button.  
The operating modes menu opens.
3. Select the "Settings" operating mode.  
The first basic setting appears and can be changed using the rotary selector.
4. Touch the > arrow.
5. Use the rotary selector to change the values.
6. Use the > arrow to switch to the next basic settings.
7. Press the menu button to save.  
"Save" or "Discard" appears on the display.

### List of settings

This list tells you all the basic settings and how to change them. Depending on the model of the appliance you own, the display will show only those settings that apply to your appliance.

You can change the following settings:

Setting	Options
Select language	Additional languages possible
Time of day	Sets the current time
Date	Sets the current date
Water hardness	0 (softened)
	1 (soft)
	2 (medium)
	3 (hard)
	4 (very hard)
Audible signal duration	Short (30 s)
	Medium (1 m)
	Long (5 m)
Button tone	Switched off (button tone still sounds when switching on/off using the "On/off" button)
	Switched on
Display brightness	Can be adjusted to one of five different levels
Clock display	Digital with date
	Analogue
	Off
Lighting	On during operation
	Off during operation
Childproof lock*	Door lock + button lock
	Button lock only

Operation after switching on	Main menu
	Heating modes
	Steaming
	Dishes*
Night-time dimming	Switched off
	Switched on (display dimmed between 10 p.m. and 5.59 a.m.)
Brand name logo	Display
	Do not display
Fan run-on time	Recommended
	Minimum
Pull-out system	Not retrofitted
	Retrofitted
Sabbath mode	Switched on
	Switched off
Factory settings	Restore
	Do not restore

\*) Included, depending on appliance model

#### Caution!

For shelves and single rails: "Not retrofitted" setting.  
For sets of two or three rails: "Retrofitted" setting.

**Note:** Changes to the language, button tone and display brightness settings take effect immediately. All other changes take effect after the settings have been saved.

### Changing the time

You can change the time in the basic settings.

For example: Changing from summer to winter time.

1. Press the On/Off button.
2. Press the menu button.  
The operating modes menu opens.
3. Touch "Settings".
4. Use the > arrow to switch to "Clock".
5. Use the rotary selector to change the time.
6. Press the menu button.  
"Save" or "Discard" appears on the display.

#### Power cut

Following a long power cut, the settings for initial use are shown in the display.

Reset the language, time and date.

## Sabbath mode

With the Sabbath mode, a cooking time of up to 74 hours can be set. You can keep the food in the cooking compartment warm without having to switch the oven on or off.

### Starting Sabbath mode

Prerequisite: "Sabbath mode activated" is activated in the basic settings. → *"Basic settings" on page 22*

The cooking compartment heats up with top/bottom heating and a temperature between 85 °C and 140 °C.

1. Press the On/Off button.  
A type of heating and a temperature are suggested in the display.
2. Turn the rotary selector anti-clockwise and select the "Sabbath mode" type of heating.
3. Touch the suggested temperature and set the temperature using the rotary selector.
4. Press the  button to open the time-setting options menu and touch the "Cooking time" field.  
25:00 hours are suggested.
5. Use the rotary selector to set the required cooking time.
6. Press the Start/Stop button to start.  
You can see the cooking time counting down in the status bar.

### The cooking time has elapsed

A signal sounds. The oven stops heating. "Finished" appears in the status bar.

### Setting a later end time

It is not possible to set a later end time.

### Cancelling Sabbath mode

Press the On/Off button. All settings are deleted. You can apply new settings.

## Cleaning function

Your appliance has the "Cleaning function" and "Descaling" operating modes. The self-cleaning surfaces in the cooking compartment are cleaned with the cleaning function. You can use the "descaling" operating mode to remove limescale from the evaporator.

### Cleaning function

The self-cleaning surfaces (back panel, ceiling panel and side panels) are coated with a porous, matt ceramic material. This coating absorbs and breaks down splashes from baking, roasting and grilling while the oven is in operation. If the surfaces no longer clean themselves adequately and dark patches appear, the surfaces can be cleaned by the cleaning function.

**Note:** The appliance records the number of times it is used. The appliance indicates when it has reached a point in time after which cleaning is recommended. The recommendation is displayed until the cleaning function has finished.

If you do not act on this recommendation, the self-cleaning surfaces may become damaged.

If your appliance is already prematurely very dirty or if you notice dark patches on the back panel, do not wait until your appliance recommends cleaning to do so.

This is because the more often the appliance is cleaned, the longer the self-cleaning surfaces will retain their cleaning capability. You can clean your appliance at any time as required using the cleaning function.

### Caution!

If your appliance has a steam function, the messages recommending that you descale the appliance and that you run the cleaning function may appear at the same time. Follow the recommendation to descale the appliance. The recommendation to run the cleaning function does not appear on the display again until you have descaled the appliance.

### Prior to initiating the cleaning function

Remove shelves, rails, accessories and ovenware from the cooking compartment.

### Cleaning the cooking compartment floor and the inside of the appliance door

Remove the worst dirt from the cooking compartment floor, the inside of the appliance door and the interior lighting. Otherwise, patches will appear that can no longer be removed.

### Caution!

Do not use oven cleaner on the self-cleaning surfaces. This will damage the surfaces. If oven cleaner does come into contact with these surfaces, dab it off immediately with water and a sponge cloth. Please to not rub or use any abrasive cleaning materials.

## Setting the cleaning function

Cleaning lasts 60 minutes.  
The duration cannot be changed.

1. Press the menu button.  
The operating modes menu opens.
2. Select the "Cleaning function" operating mode.  
If you touch the "Next" field, information on the cleaning operation is displayed.
3. Press the "Start/stop" button to start the cleaning operation.  
You can see the duration counting down in the status bar.  
Keep the kitchen ventilated while cleaning is in progress.

## Once the cleaning has finished

An audible signal sounds. The oven stops heating. "Finished" appears in the status bar. Use the  button to switch off the audible signal. "Appliance cooling down" appears in the status bar.

## Cancelling cleaning

Press the On/Off button. All settings are deleted. You can implement new settings.

## Caution!

The cleaning recommendation is not reset. The recommendation to run the cleaning function appears on the display.

## You can set the cleaning to run overnight

In the section "Time settings", you can find out how to delay the end time. This allows you to use the oven at any time throughout the day. → "Time-setting options" on page 20

## Once the cleaning function has ended

Once the cooking compartment has cooled down, wipe down the cooking compartment with a damp cloth if necessary.

**Note:** During operation and while the cleaning function is active, reddish patches may form on the surfaces. This is not rust, but food residues. These patches are not hazardous to your health and do not limit the cleaning capacity of the self-cleaning surfaces.

## Descaling

The appliance must be descaled regularly in order for it to continue operating correctly.

There are several steps in the descaling programme. For hygiene reasons, the descaling programme must be run through completely so that the appliance can be ready for operation again. In total, the descaling programme runs for approx. 70-90 minutes.

- Descal (approx. 55-70 minutes), then empty and refill the water tank
- First rinsing cycle (approx. 6-9 minutes), then empty and refill the water tank
- Second rinsing cycle (approx. 6-9 minutes), then empty and dry the water tank

If the descaling process is interrupted (for example, due to a power failure or because the appliance has been switched off), you are prompted to rinse the appliance twice after it is switched back on. The appliance cannot be used until the second rinsing cycle has come to an end.

The frequency with which the appliance must be descaled depends on the hardness of the water used. When only five more steam-assisted operations are possible, or fewer, the appliance reminds you to descale it with a message on the display. The number of remaining operations is displayed after the appliance is switched on. You can therefore prepare for the descaling in good time.

## Start

### Caution!

- Damage to the appliance: Use only liquid descalers that are recommended by us for the descaling programme. The time the product needs to work during descaling depends on the type of descaler used. Other descalers may damage the appliance. Descaler order no. 311 680
- Descaling solution: Do not allow any descaling solution or descaler to come into contact with the control panel or other delicate surfaces. This will damage the surfaces. If this does happen, remove the descaling solution immediately with water.

If you have used a steam-assisted operation immediately before descaling, you must first switch the appliance off so that the residual water is pumped out of the evaporator system.

1. Mix 400 ml water with 200 ml liquid descaler to make a descaling solution.
2. Press the On/Off button.
3. Remove the water tank and fill with descaling solution.
4. Fully insert the water tank filled with the descaling solution.
5. Close the control panel.
6. Press the Menu button.  
The operating modes menu opens.



7. Select the "Descaling" operating mode.  
If you touch the "Next" field, information on the cleaning operation is displayed.  
The duration of the descaling programme is displayed. It cannot be changed.
8. Press the "Start/stop" button to start the cleaning operation.  
The appliance is descaled. You can see the duration counting down in the status bar. As soon as the descaling programme has finished, an audible signal sounds.

### First rinsing cycle

1. Open the control panel.
2. Remove the water tank, rinse thoroughly, fill with water and reinsert.
3. Close the control panel.
4. Press the Start/Stop button to start.  
The appliance rinses. As soon as the rinsing cycle has run through, a signal sounds.

### Second rinsing cycle

1. Open the control panel.
2. Remove the water tank, rinse thoroughly, fill with water and reinsert.
3. Close the control panel.
4. Press the Start/Stop button to start.  
The appliance rinses. As soon as the rinsing cycle has run through, a signal sounds.

### Final cleaning

1. Open the control panel.
2. Empty and dry the water tank.
3. Switch off the appliance.  
Descaling is complete and the appliance is ready for use again.

## Cleaning agent

With good care and cleaning, your appliance will retain its appearance and remain fully functioning for a long time to come. We will explain here how you should correctly care for and clean your appliance.

### Suitable cleaning agents

To ensure that the different surfaces are not damaged by using the wrong cleaning agent, observe the information in the table. Depending on the appliance model, not all of the areas listed may be on/in your appliance.

#### Caution!

#### Risk of surface damage

Do not use:

- Harsh or abrasive cleaning agents,
- Cleaning agents with a high alcohol content,
- Hard scouring pads or cleaning sponges,
- High-pressure cleaners or steam cleaners,
- Special cleaners for cleaning the appliance while it is hot.

Wash new sponge cloths thoroughly before use.

**Tip:** Highly recommended cleaning and care products can be purchased through the after-sales service. Observe the respective manufacturer's instructions.

#### Warning – Risk of burns!

The appliance becomes very hot. Never touch the interior surfaces of the cooking compartment or the heating elements. Always allow the appliance to cool down. Keep children at a safe distance.

Area	Cleaning
<b>Appliance exterior</b>	
Stainless steel front	Hot soapy water: Clean with a dish cloth and then dry with a soft cloth.  Remove flecks of limescale, grease, starch and albumin (e.g. egg white) immediately. Corrosion can form under such flecks.  Special stainless steel cleaning products suitable for hot surfaces are available from our after-sales service or from specialist retailers. Apply a very thin layer of the cleaning product with a soft cloth.
Plastic	Hot soapy water: Clean with a dish cloth and then dry with a soft cloth.  Do not use glass cleaner or a glass scraper.
Painted surfaces	Hot soapy water: Clean with a dish cloth and then dry with a soft cloth.
Control panel	Hot soapy water: Clean with a dish cloth and then dry with a soft cloth.  Do not use glass cleaner or a glass scraper.

Door panels	Hot soapy water: Clean with a dish cloth and then dry with a soft cloth. Do not use a glass scraper or a stainless steel scouring pad.
Door handle	Hot soapy water: Clean with a dish cloth and then dry with a soft cloth. If descaler comes into contact with the door handle, wipe it off immediately. Otherwise, any stains will not be able to be removed.
<b>Appliance interior</b>	
Enamel surfaces and self-cleaning surfaces	Observe the instructions for the surfaces of the cooking compartment that follow the table.
Glass cover for the interior lighting	Hot soapy water: Clean with a dish cloth and then dry with a soft cloth. If the cooking compartment is heavily soiled, use oven cleaner.
Door seal Do not remove.	Hot soapy water: Clean with a dish cloth. Do not scour.
Stainless steel door cover	Stainless steel cleaner: Observe the manufacturer's instructions. Do not use stainless steel care products. Remove the door cover for cleaning.
Rails	Hot soapy water: Soak and clean with a dish cloth or brush.
Pull-out system	Hot soapy water: Clean with a dish cloth or a brush. Do not remove the lubricant while the pull-out rails are pulled out – it is best to clean them when they are pushed in. Do not clean in the dishwasher.
Accessories	Hot soapy water: Soak and clean with a dish cloth or brush. Clean dirt on stainless steel roasting dishes caused by starchy foods (e.g. rice) using a vinegar solution.
Water tank	Hot soapy water: Clean with a dish cloth and rinse thoroughly to remove residual detergent. Then dry with a soft cloth. Leave the water tank to dry with the lid open. Rub the seal on the lid until dry. Do not clean in the dishwasher.

**Notes**

- Slight differences in colour on the front of the appliance are caused by the use of different materials, such as glass, plastic and metal.
- Shadows on the door panels, which look like streaks, are caused by reflections made by the interior lighting.
- Enamel is baked on at very high temperatures. This can cause some slight colour variation. This is normal and does not affect operation. The edges of thin trays cannot be completely enamelled. As a result, these edges can be rough. This does not impair the anti-corrosion protection.

**Surfaces in the cooking compartment**

The back wall, ceiling and side parts in the cooking compartment are self-cleaning. You can tell this from the rough surface.

The cooking compartment floor is enamelled and has smooth surfaces.

**Cleaning enamelled surfaces**

Clean the smooth enamelled surfaces with a dish cloth and hot soapy water or a vinegar solution. Then dry with a soft cloth.

Soften baked-on food residues with a damp cloth and soapy water. Use stainless steel wire wool or oven cleaner to remove stubborn dirt.

Leave the cooking compartment open to dry after cleaning.

**Note:** Food residues can cause white deposits to form. These are harmless and do not affect how the appliance works. You can remove these residues using lemon juice if required.

**Cleaning self-cleaning surfaces**

The self-cleaning surfaces are coated with a porous, matte ceramic layer. This coating absorbs and dispels splashes from baking and roasting while the appliance is in operation.

If the self-cleaning surfaces no longer clean themselves sufficiently and dark stains appear, they can be cleaned using the cleaning function. To do this, refer to the information in the relevant section. → "Cleaning function" on page 23

**Caution!**

Do not use oven cleaner on self-cleaning surfaces. This will damage the surfaces. If oven cleaner does get onto these surfaces, dab it off immediately using water and a sponge cloth. Do not rub the surface and do not use abrasive cleaning aids.

**Keeping the appliance clean**

Always keep the appliance clean and remove dirt immediately so that stubborn deposits of dirt do not build up.

**Tips**

- Clean the cooking compartment after each use. This will ensure that dirt cannot be baked on.
- Always remove flecks of limescale, grease, starch and albumin (e.g. egg white) immediately.
- Use the universal pan for baking very moist cakes.
- Use suitable ovenware for roasting, e.g. a roasting dish.

## Rails

With good care and cleaning, your appliance will retain its appearance and remain fully functional for a long time to come. This will tell you how to remove the shelves and clean them.

### Detaching and refitting the rails

#### Warning – Risk of burns!

The rails become very hot. Never touch the hot rails. Always allow the appliance to cool down. Keep children away from the appliance.

#### Detaching the rails

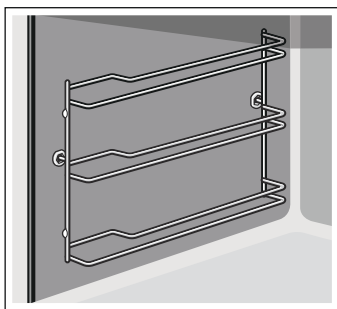

1. Lift the rail slightly at the front **a** and detach it **b** (figure **1**).
2. Then pull the whole rail towards you and take it out (figure **2**).

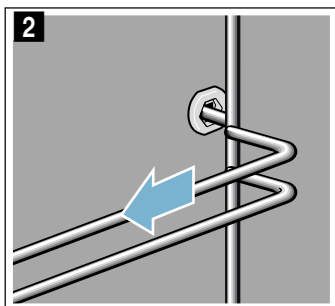
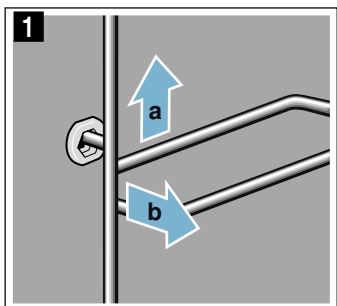

Clean the rails with cleaning agent and a sponge. For stubborn deposits of dirt, use a brush.

### Attaching the rails

The rails only fit on the right or the left side. For both rails, ensure that the curved rods are at the front.

1. First, insert the rail in the middle of the rear socket **a**, until the rail rests against the cooking compartment wall, and push it back **b** (figure **1**).
2. Then insert the rail into the front socket **c**, until the rail also rests against the cooking compartment wall here, and press it downwards **d** (figure **2**).

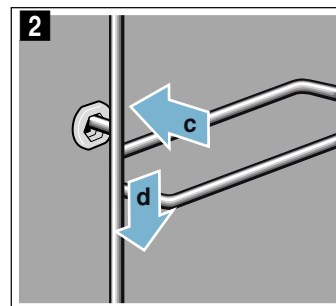
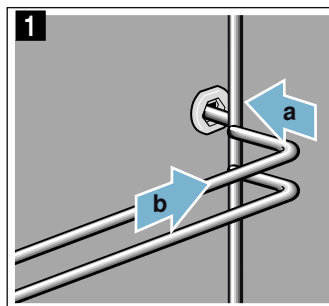

## Appliance door

With good care and cleaning, your appliance will retain its appearance and remain fully functional for a long time to come. This will tell you how to remove the appliance door and clean it.

### Removing and fitting the appliance door

For cleaning purposes and to remove the door panels, you can detach the appliance door.

The appliance door hinges each have a locking lever. When the locking levers are closed (figure 1), the appliance door is secured in place. It cannot be detached.

When the locking levers are open in order to detach the appliance door (figure 2), the hinges are locked. They cannot snap shut.

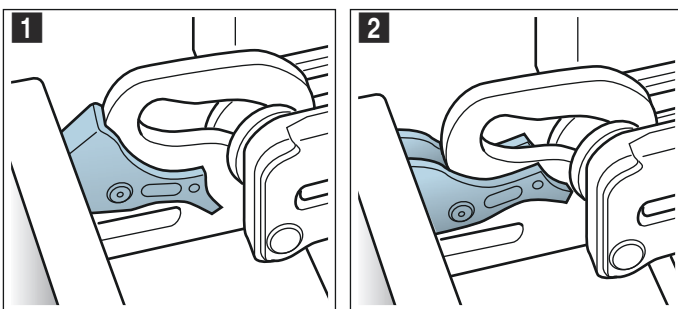

#### **Warning** Risk of injury!

- If the hinges are not locked, they can snap shut with great force. Ensure that the locking levers are always fully closed or, when detaching the appliance door, fully open.
- The hinges on the appliance door move when opening and closing the door, and you may be trapped. Keep your hands away from the hinges.

### Removing the appliance door

1. Open the appliance door fully and push it in the direction of the appliance.
2. Fold up the two locking levers on the left and right (figure 1).
3. Close the appliance door as far as it goes **a**. With both hands, grip the door on the left- and right-hand side and pull it up and out (figure 2).

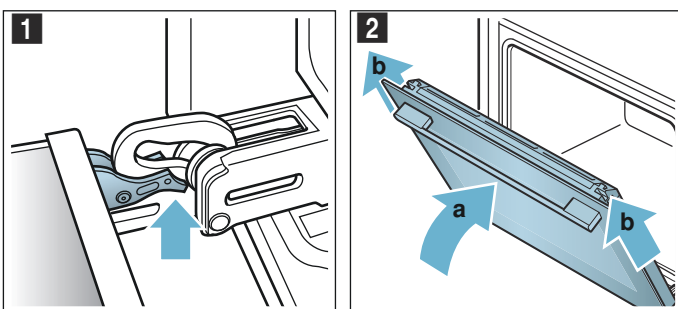

### Fitting the appliance door

Reattach the appliance door in the opposite sequence to removal.

1. When attaching the appliance door, ensure that both hinges are inserted straight into the opening (figure 1).  
Place both hinges at the bottom on the outer panel and use this as a guide.  
Ensure that the hinges are inserted into the correct opening. You must be able to insert them easily and without resistance. If you can feel any resistance, check that the hinges are inserted into the correct opening.

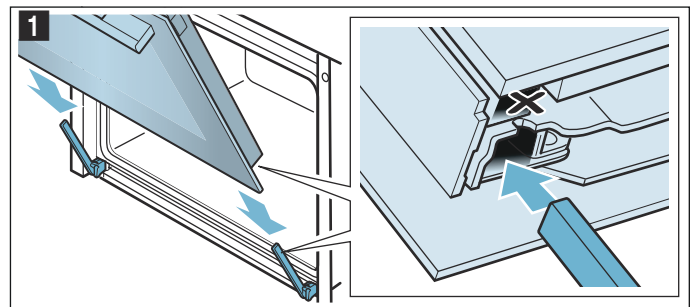

2. Open the appliance door fully. Fold both locking levers closed again (figure 2).

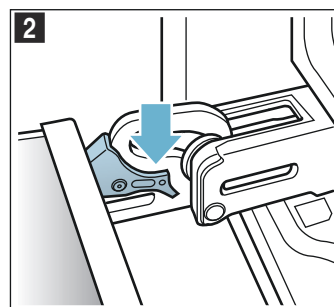

3. Close the cooking compartment door.

### Removing the door cover

The stainless steel inlay in the door cover may become discoloured. To carry out thorough cleaning, you can remove the cover.

1. Open the appliance door slightly.
2. Press on the right and left side of the cover (figure 1).
3. Remove the cover (figure 2).  
Close the appliance door carefully.

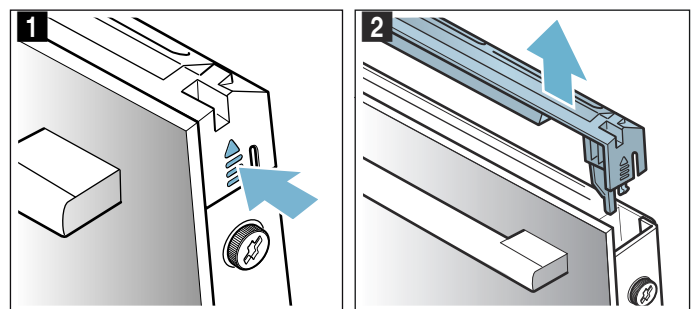

**Note:** Clean the stainless steel inlay in the cover with stainless steel cleaner. Clean the rest of the door cover with soapy water and a soft cloth.

4. Open the appliance door again slightly. Put the cover back in place and press on it until it clicks audibly into place (figure 3).

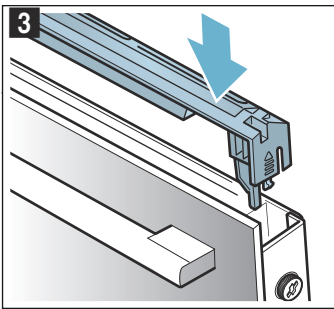

5. Close the appliance door.

## Removing and installing the door panels

To facilitate cleaning, you can remove the glass panels from the appliance door.

### Removing the door from the appliance

1. Open the appliance door slightly.
2. Press on the right and left side of the cover (figure 1).
3. Remove the cover (figure 2).

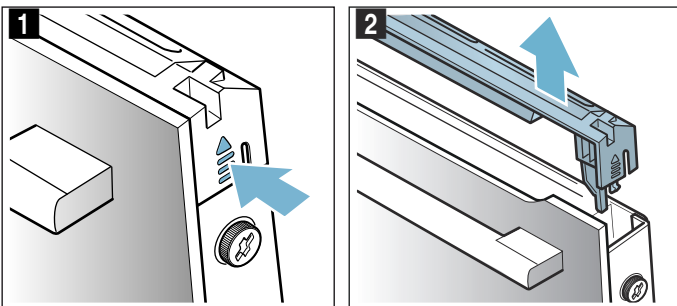

4. Loosen and remove the screws on the left and right of the appliance door (figure 3).
5. Before closing the door again, trap a tea towel which has been folded several times in the door (figure 4). Pull out the front panel upwards and lay it on a flat surface with the door handle facing downwards.

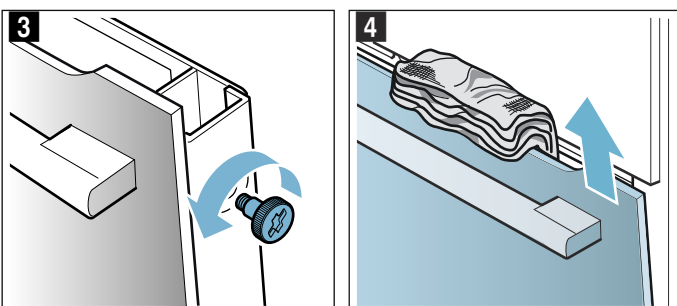

Clean the panels with glass cleaner and a soft cloth.

### **Warning**

#### Risk of injury!

- Scratched glass in the appliance door may develop into a crack. Do not use a glass scraper, sharp or abrasive cleaning aids or detergents.
- The hinges on the appliance door move when opening and closing the door, and you may be trapped. Keep your hands away from the hinges.

### Fitting the door on the appliance

1. Insert the front panel at the bottom into the retainers (figure 1).
2. Close the front panel until both upper hooks are opposite the opening (figure 2).

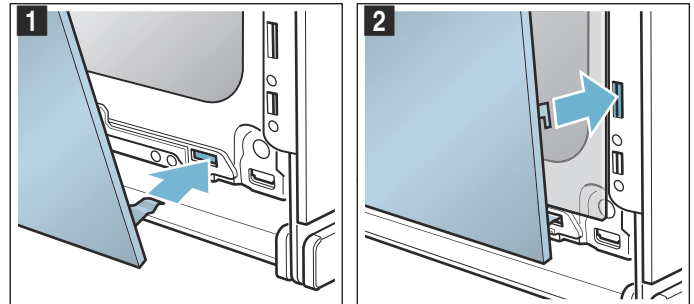

3. Press the front panel at the bottom until it clicks audibly into place (figure 3).
4. Open the appliance door again slightly and remove the tea towel.
5. Screw both screws back in on the left and right.
6. Put the cover back in place and press on it until it clicks audibly into place (figure 4).

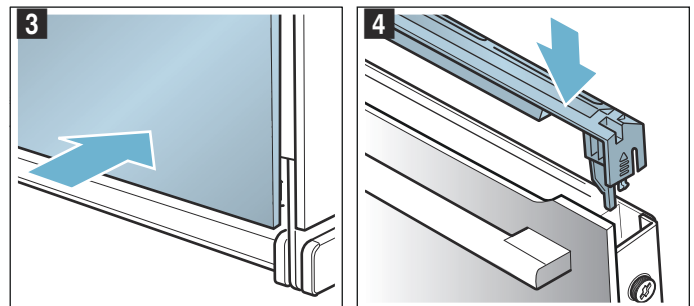

7. Close the appliance door.

### Caution!

Do not use the cooking compartment again until the panels have been correctly fitted.

## Trouble shooting

If a fault occurs, there is often a simple explanation. Before calling the after-sales service, please refer to the fault table and attempt to correct the fault yourself.

**Note:** If a dish does not turn out as well as you had hoped, refer to the table section at the end of the instruction manual, where you will find plenty of tips and information. → *"Tested for you in our cooking studio" on page 33*



### Fault table

If an error message beginning with 'E' is shown, e.g. E0111, switch the appliance off and then on again. If

### Warning – Risk of electric shock!

Incorrect repairs are dangerous. Repairs may only be carried out and damaged power cables replaced by one of our trained after-sales technicians. If the appliance is defective, unplug the appliance from the mains or switch off the circuit breaker in the fuse box. Contact the after-sales service.

this message appears again, contact the after-sales service.

Fault	Possible cause	Information/remedial action
The appliance does not work	The fuse is faulty	Check in the fuse box to make sure that the fuse for the appliance is in working order
	Power cut	Check whether other kitchen appliances are working
Although the appliance is switched on, it cannot be operated; the  symbol is shown in the display	The child lock is activated	Press and hold the  button until the  symbol goes out
The cooking compartment does not heat and "Demo mode on" is shown in the display	The appliance is in demo mode	Switch off the fuse in the fuse box and switch it back on again after approx. 10 seconds. Switch on the appliance and select "Demo mode off" in the settings.
The appliance will not start and "Cooking compartment too hot" appears on the display	The cooking compartment is too hot for the selected dish or type of heating	Allow the cooking compartment to cool down and start again
The interior lighting has failed	The LED bulb is defective	Call the after-sales service
Operations with steam or descaling do not start or do not continue	Water tank empty	Refill water tank
	The panel is open	Close the panel
	Descaling locks operations with steam	Carry out descaling
	Faulty sensor	Call the after-sales service
The appliance prompts you to rinse	The power supply was interrupted or the appliance was switched off during the descaling process	Once the appliance is switched on again, rinse it twice
The appliance prompts you to descale without the counter appearing beforehand	The set water hardness range is too low	Carry out descaling Check the set water hardness range and adjust it, if necessary
Buttons flash	Normal occurrence caused by condensation behind the control panel	As soon as the condensation has evaporated, the buttons no longer flash
Cooked dishes turn out too moist or too dry when cooking with steam-assisted applications	The wrong steam intensity was selected	Select a higher or lower steam intensity
The "Fill water tank" message appears even though the water tank is full	The panel is open	Close the panel
	The water tank is not clicked into place	Click the water tank into place → <i>"Steam" on page 16</i>
	Faulty sensor	Call the after-sales service
	The water tank has fallen off. Due to the impact, components inside the water tank have come loose, and the tank is leaking.	Order a new water tank

The panel for removing the tank does not open	The plug is not plugged into the mains	Connect the appliance to the electricity supply
	Power cut	Check whether other kitchen appliances are working
	The circuit breaker is faulty	Check in the fuse box to make sure that the fuse for the appliance is in working order
	 field sensor faulty	Call the after-sales service If required, empty the water tank: Open the appliance door, take hold of the lower part of the panel on the left and right with your fingers and pull out the panel
Steam escapes from the ventilation slots during cooking	Normal procedure	Not possible
When you cook with steam, a lot of steam is produced	The appliance is being automatically calibrated	Normal procedure
When cooking with steam, a lot of steam is produced repeatedly	The appliance is unable to calibrate itself automatically if cooking times are too short	Reset the appliance to the factory settings and repeat the calibration process
There is a "pop" noise during cooking	Cold/warm effect with frozen food, caused by the steam	Not possible

## Maximum operating time exceeded

Your appliance automatically ends the operation if no duration has been set and the setting has not been changed for a long time.

The point at which this occurs depends on the temperature or grill setting that has been set.

A message appears on the display on the appliance to say that the operation is being ended automatically. The operation is then cancelled.

To use the appliance again, first switch it off. To switch the appliance back on again set the required operation.

**Tip:** Set a cooking time so that the appliance does not switch off when you do not want it to, e.g. with an extremely long preparation time. The appliance heats up until the set cooking time has elapsed.

## Cooking compartment bulbs

To light the interior of your cooking compartment, your appliance has one or more long-life LED bulbs.

However, if ever an LED bulb or the bulb's glass cover is defective, call the after-sales service. The lamp cover must not be removed.

## Customer service

Our after-sales service is there for you if your appliance needs to be repaired. We will always find an appropriate solution, also in order to avoid after-sales personnel having to make unnecessary visits.

## E number and FD number

When calling us, please quote the full product number (E no.) and the production number (FD no.) so that we can provide you with the correct advice. The rating plate bearing these numbers can be found when you open the appliance door.

If your appliance operates with steam, you will find the rating plate on the right-hand side behind the panel.

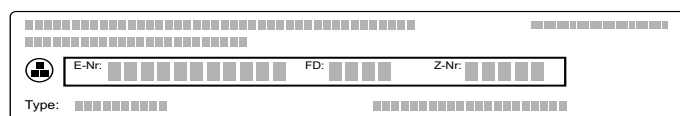

To save time, you can make a note of the numbers for your appliance and the telephone number of the after-sales service in the space below in case you need them.

E no.

FD no.

### After-sales service

Please note that a visit from an after-sales service engineer is not free of charge in the event that the appliance has been misused, even during the warranty period.

Please find the contact data of all countries in the enclosed customer service list.

### To book an engineer visit and product advice

**GB** 0344 892 8999

Calls charged at local or mobile rate.

**IE** 01450 2655

0.03 € per minute at peak. Off peak 0.0088 € per minute.

Rely on the professionalism of the manufacturer. You can therefore be sure that the repair is carried out by trained service technicians who carry original spare parts for your appliances.

## Dishes

You can use the "Dishes" operating mode to prepare a wide variety of food. The appliance chooses the optimal setting for you.

To achieve good results, the cooking compartment must not be too hot for the type of food you have selected. If it is, a message will appear on the display. Allow the cooking compartment to cool down and start again.

### Information on the settings

- The cooking result depends on the quality of the food and the size and type of cookware. For an optimal cooking result, use food that is in good condition and chilled meat only. For frozen food, use food straight out of the freezer only.
- For some food, a temperature, heating mode and cooking time is suggested. The temperature and the cooking time can be changed according to your requirements.
- For other dishes, you will be asked to enter the weight. Always enter the total weight unless the appliance asks for something different. The appliance will then apply the time and temperature settings for you.  
It is not possible to set weights outside of the intended weight range.
- When roasting dishes for which the appliance will apply the temperature selection for you, temperatures of up to 300 °C can be saved. Therefore, make sure that you use cookware that is sufficiently heat resistant.
- Information is provided, e.g. on cookware, shelf position or the addition of liquid when cooking meat. Some food requires turning or stirring, etc., during cooking. This is shown in the display shortly after operation starts. An audible signal will remind you at the right time.
- Information on the right kind of cookware to use and tips and tricks for the preparation can be found at the end of the instruction manual. → "Tested for you in our cooking studio" on page 33

### Steam

For some food, the steam function is automatically activated. The appliance instructs you to fill the water tank. General information on the steam function can be found in the relevant section. → "Steam" on page 16

The cooking time is displayed after operation starts. It does not start counting down until the set temperature has been reached.

### Warning – Risk of scalding!

When you open the appliance door, hot steam can escape. Steam may not be visible, depending on its temperature. When opening, do not stand too close to the appliance. Open the appliance door carefully. Keep children away.

## Selecting a dish

The dishes are arranged in a uniform structure:

- Category
- Food
- Dish

The following table lists the categories with the corresponding food. One or more dishes are listed beside each food.

Categories	Food
Cake	Cakes in tins
	Cakes on baking trays
	Small baked items
	Biscuits
Bread, bread rolls	Bread
	Bread rolls
Pizza, savoury cakes	Pizza
	Savoury cakes, quiches
Bakes, soufflés	Lasagne, fresh
	Soufflé in individual moulds
	Fruit crumble
	Yorkshire pudding
Frozen products	Pizza
	Bread rolls
	Bakes
	Potato products
	Poultry, fish
Poultry	Vegetables
	Chicken
	Duck, goose
Meat	Turkey
	Pork
	Beef
	Lamb
Fish	Meat dishes
	Fish, whole
	Fish fillets
	Fish steaks
	Fish dishes
Side dishes, vegetables	Seafood
	Vegetables
	Potatoes
	Rice
	Cereals
	Pulses
	Pasta, dumplings
Eggs	
Dessert, compote	Dessert, compote
Preserve, juice, sterilise	Sterilising bottles



Categories	Food
Reheat, crisp up	Vegetables
	Menu
	Baked goods
	Side dishes
Defrosting food	Fruit, vegetables

## Applying settings for dishes

You will be guided through the entire setting process for your chosen food. Always touch the "Next" field.

1. Press the menu button.  
The operating modes menu will open.
2. Select "Dishes" mode.  
The first category will appear on the display.
3. Use the rotary selector to select the category you require.
4. Touch the "Next" field.
5. Use the rotary selector to select the food.
6. Touch the "Next" field.
7. Use the rotary selector to select the dish.
8. Touch the "Next" field.
9. Turn the rotary selector to set the weight.  
**Note:** Touch the "Tip" field for information on the best shelf position, cookware, etc. to use.
10. Press the Start/Stop button to start.

## The setting has ended

A signal sounds. "Finished" appears in the status bar. The oven stops heating. You can cancel the audible signal early using the  button.

If you are not satisfied with the cooking result, you can increase the cooking time again. Touch the "Extend cooking time" field. A cooking time is suggested. However, you can change this if you want.

If you are satisfied with the cooking result, touch "Finish". "Enjoy your meal" appears in the display.

## Cancelling the setting

Press the On/Off button. All settings are deleted. You can implement new settings.

## Setting a later end time

For some dishes, it is possible to set a later end time. You can find out how to set a later end time by looking in the time-setting options. → *"Time-setting options" on page 20*

Once you have set an end time, the display shows the waiting time. The status bar shows the time at which operation is to end. None of the settings can be changed. Please remember that easily spoiled foods must not be allowed to remain in the cooking compartment for too long.

## Tested for you in our cooking studio

Here, you can find a selection of dishes and the ideal settings for them. We will show you which type of heating and temperature are best suited to your dish. You will get information on suitable cooking accessories and the height at which they should be placed in the oven. You will also get tips about cookware and preparation methods.

**Note:** A lot of steam can build up in the cooking compartment when cooking food. Your appliance is very energy-efficient and radiates very little heat to its surroundings during operation. Due to the high difference in temperature between the appliance interior and the external parts of the appliance, condensation may build up on the door, control panel or adjacent kitchen cabinet panels. This is a normal physical phenomenon. Condensation can be reduced by preheating the oven or opening the door carefully. When steaming or during operation with steam assistance, it is desirable that there is a significant build-up of steam in the cooking compartment. Wipe the cooking compartment clean after cooking, once it has cooled off.

## Silicone moulds

For the best cooking results, we recommend dark-coloured metal baking tins/dishes.

Nevertheless, if you wish to use silicone moulds, follow the manufacturer's instructions and recipes. Silicone moulds are often smaller than normal baking tins. Quantity and recipe specifications may vary.

Silicone moulds are unsuitable for steam-assisted cooking and steaming.

## Baking

Here, you can find recommended settings for many dishes.

Also refer to the notes in the section on allowing dough to rise.

Only use original accessories supplied with your appliance. These have been tailored to the cooking compartment and the operating modes of your appliance.

## Steam-assisted baking

Certain types of baked item (e.g. yeast-risen pastries) get a more crispy crust and a more glossy surface if baked with the steam assist mode. The baked item does not dry out as much.

Steam-assisted baking is only possible on one level.

Some food turns out better if it is baked in several stages. These dishes are indicated in the table.

### Shelf positions

Use the indicated shelf positions.

#### Baking on one level

When baking on one level, use the following shelf position:

- Level 1

#### Baking on two levels

Use 4D hot air. Baked items that are placed into the oven on trays or in baking tins/dishes at the same time will not necessarily be ready at the same time.

- Universal pan: Level 3  
Baking tray: Level 1
- Baking tins/dishes on the wire rack  
First wire rack: Level 3  
Second wire rack: Level 1

By preparing several dishes at the same time, you can make energy savings of up to 45 per cent. Position baking tins/dishes next to one another or offset and vertically stacked in the cooking compartment.

### Accessories

Ensure that you always use suitable accessories and that they are placed in the oven the right way around.

#### Wire rack

Insert the wire rack with the open side facing the appliance door and the curved lip pointing downwards. Always place ovenware, tins and dishes on the wire rack.

#### Universal pan or baking tray

Slide the universal pan or the baking tray in carefully as far as the limit stop with the bevelled edge facing the appliance door.

When baking moist cakes or pastries with many toppings, use the universal pan so that any excess liquid does not overflow and make the cooking compartment dirty.

#### Baking tins

Dark- coloured metal baking tins are most suitable.

Tinplate baking tins, ceramic dishes and glass dishes extend baking time and mean that the baked item will not brown evenly.

The baking tins must be resistant to heat and steam for use in steam-assisted baking.

### Greaseproof paper

Only use greaseproof paper that is suitable for the selected temperature. Always cut greaseproof paper to size.

### Recommended setting values

The table lists the optimal heating type for various baked items. The temperature and baking time depend on the amount and consistency of the dough/mixture. For this reason, the table specifies setting ranges. Try using the lower values to start with. A lower temperature will result in more even browning. You can use a higher setting next time if necessary.

**Note:** Baking times cannot be reduced by using higher temperatures. Cakes or small baked items would only be cooked on the outside, and would not be fully baked in the middle.



The setting values apply to food that is placed into a cold cooking compartment; by doing this, you can make energy savings of up to 20 per cent. If you preheat the oven, you can reduce the indicated baking times by several minutes.

Preheating is necessary for selected food, and this is indicated in the table. Do not place your food or accessories into the cooking compartment until it has finished preheating.

If you wish to follow one of your own recipes when baking, you should use the setting values listed for similar baked items in the table as reference. Additional information can be found in the baking tips listed after the settings table.







Remove unused accessories from the cooking compartment. This will ensure that you achieve the best possible cooking results and energy savings of up to 20 per cent.

Types of heating used:

-  4D hot air
-  Pizza setting
-  Steaming

The levels of steam intensity are indicated as numbers in the table:

- 1 = Low
- 2 = Medium
- 3 = High

Dish	Accessories/cookware	Shelf position	Type of heating	Temperature in °C	Steam intensity	Cooking time in mins.
<b>One level baking</b>						
Victoria sponge cake	2x Ø20 cm tins	1		160-170*	-	20-30
Victoria sponge cake	2x Ø20 cm tins	1		150-160	1	25-35
Light fruit cake	high Ø20cm tin	1		140-160	-	70-90
Light fruit cake	high Ø20 cm tin	1		140-150	1	90-100
Rich Fruit Cake	high Ø23cm tin	1		130-150	-	150-180
Fruit crumble	flat glass dish	2		150-170*	-	30-45
Sponge Cake (fatless), 3 eggs	springform cake tin, Ø26 cm	1		160-170*	-	25-35

\* Preheat

Dish	Accessories/cookware	Shelf position	Type of heating	Temperature in °C	Steam intensity	Cooking time in mins.
Sponge Cake (fatless), 3 eggs	springform cake tin, Ø26 cm	1	☉	150-160	1	10
					-	25-35
Sponge flan, 6 eggs	springform cake tin, Ø28 cm	1	☉	150-170*	-	30-50
Sponge flan, 6 eggs	springform cake tin, Ø28 cm	1	☉	150-160	1	10
					-	30-35
Swiss Roll	swiss roll tin	2	☉	180-190*	-	10-18
Swiss Roll	swiss roll tin	2	☉	180-190*	1	10-15
Fruit Pie	plate Ø20cm or pie tin	1	☉	180-190	-	45-50
Quiche	quiche tin (dark coated)	1	☉	190-210	-	30-45
(White) Bread	loaf tin (1x 900 g or 2x 450 g)	1	☉	190-210*	-	20-30
(White) Bread	loaf tin (1x 900 g or 2x 450 g)	1	☉	210-220	3	10-15
				180-190	-	25-35
Scones	baking tray	1	☉	180-200*	-	10-14
Biscuits	baking tray	2	☉	140-160*	-	10-25
Small cakes	12-cup-tin	1	☉	140-160*	-	20-35
Puff pastry slices	baking tray	2	☉	170-190*	-	20-45
Puff pastry slices	baking tray	1	☉	210-220*	1	15-25
Jam tarts	12-cup-tin	2	☉	160-180*	-	15-30
Meringue	baking tray	2	☉	90-100*	-	100-130
Pavlova	baking tray	2	☉	90-100*	-	120-180
Soufflé	1,2 L-soufflé dish	1	☉	160-170*	-	40-50
Soufflé	1,2 L-soufflé dish	1	☉	170-180	2	35-45
Soufflé	individual moulds	1	☼	100	-	40-45
Choux pastry	baking tray	1	☉	190-210*	-	30-40
Choux pastry	baking tray	1	☉	200-220*	1	25-35
Meat Pie	rectangular pie tin	1	☉	180-190	-	40-50
Meat Pie	rectangular pie tin	1	☉	170-180	2	40-50
Yorkshire Pudding	12-cup-tin	1	☉	200-220*	-	15-25
Jacket potatoes	baking tray	2	☉	150-170	-	75-90
Jacket potatoes	baking tray	2	☉	180-190	1	40-50
Pizza, homemade	baking tray	1	☉	200-220	-	20-30
Pizza, homemade	baking tray	1	☉	220-230	-	25-30
Pizza, homemade, thin base	pizza tray	1	☉	210-230	-	20-30
<b>Multishelf baking</b>						
Victoria sponge cake, 2 levels	4x Ø20 cm tins	3+1	☉	160-170*	-	20-35
Scones, 2 levels	2 baking trays	3+1	☉	180-200*	-	12-16
Biscuits, 2 levels	2 baking trays	3+1	☉	140-160*	-	15-30
Small cakes, 2 levels	2x 12-cup-tins	3+1	☉	140-160*	-	22-32
Puff pastry slices, 2 levels	2 baking trays	3+1	☉	170-190*	-	20-45
Jam tarts, 2 levels	2x 12-cup-tins	3+1	☉	160-180*	-	20-35
Meringues, 2 levels	2 baking trays	3+1	☉	90-100*	-	100-130
Jacket potatoes, 2 levels	universal pan + baking tray	3+1	☉	150-170*	-	75-90
Pizza, homemade, 2 levels	universal pan + baking tray	3+1	☉	180-200	-	35-45

\* Preheat

## Tips on baking

You want to find out whether the cake is completely cooked in the middle.	Push a cocktail stick into the highest point on the cake. If the cocktail stick comes out clean with no dough residue, the cake is ready.
The cake collapses.	Next time, use less liquid. Alternatively, set the temperature to be 10 °C lower and extend the baking time. Adhere to the specified ingredients and preparation instructions in the recipe.
The cake has risen in the middle but is lower around the edge.	Only grease the base of the springform cake tin. After baking, loosen the cake carefully with a knife.
The fruit juice overflows.	Next time, use the universal pan.
Small baked items stick to one another during baking.	There should be a gap of approx. 2 cm around each item. This gives enough space for the baked items to expand well and brown on all sides.
The cake is too dry.	Set the temperature 10 °C higher and shorten the baking time.
The cake is generally too light in colour.	If the shelf position and the cookware are correct, then you should increase the temperature if necessary or extend the baking time.
The cake is too light on top, and too dark underneath.	Bake the cake one level higher in the oven the next time.
The cake is too dark on top, and too light underneath.	Bake the cake one level lower in the oven the next time. Select a lower temperature and extend the baking time.
Cakes baked in a tray or tin are too brown at the back.	Place the baking tray in the middle of the accessories, not directly against the back wall.
The whole cake is too dark.	Select a lower temperature next time and extend the baking time if necessary.
The cake is unevenly browned.	Select a slightly lower temperature. Protruding greaseproof paper can affect the air circulation. Always cut greaseproof paper to size. Ensure that the baking tin does not stand directly in front of the openings in the cooking compartment back wall. When baking small items, you should use similar sizes and thicknesses wherever possible.
You were baking on several levels. The items on the top baking tray are darker than those on the lower baking tray.	Always select 4D hot air when baking on several levels. Baked items that are placed into the oven on trays or in baking tins/dishes at the same time will not necessarily be ready at the same time.
The cake looks good, but is not cooked properly in the middle.	Use a lower temperature and bake slightly longer; if necessary, add slightly less liquid. For cakes with a moist topping, bake the base first. Sprinkle it with almonds or breadcrumbs and then place the topping on top.
The cake cannot be turned out of the dish when it is turned upside down.	Allow the cake to cool down for 5 to 10 minutes after baking. If it still sticks, carefully loosen the cake around the edges again using a knife. Turn the cake tin upside down again and cover it several times with a cold, wet cloth. Next time, grease the baking tin/dish and sprinkle with breadcrumbs.

## Roasting and braising

Here, you can find information on roasting and braising poultry and meat. You can find the ideal settings for many dishes in the settings tables.

### Poultry

For duck or goose, pierce the skin on the underside of the wings. This allows the fat to run out.

If using duck breast, score the skin. Do not turn duck breasts.

When you turn poultry, ensure that the breast side or the skin side is underneath at first.

Poultry will turn out particularly crispy and brown if you baste it towards the end of the roasting time with butter, salted water or orange juice.

### Meat

Baste lean meat with fat as required or cover it with strips of bacon.

Score the rind crosswise. If you turn the joint when cooking, ensure that the rind is underneath at first.

When the joint is ready, turn off the oven and allow it to rest for another 10 minutes in the cooking compartment. This allows the meat juices to be better distributed. Wrap the joint in aluminium foil if necessary. The recommended resting time is not included in the cooking time indicated.

### Roasting on the wire rack

On the wire rack, poultry and meat will become very crispy on all sides. Roasting on the wire rack is well suited for larger poultry or for multiple pieces at the same time.

Depending on the size and type of the meat, add up to ½ litres of water to the universal pan. Any dripping fat and meat juices will be caught. You can prepare a sauce using these meat juices. In addition, less smoke is generated, and the cooking compartment stays cleaner.

Slide the universal pan into the oven at the indicated shelf position with the wire rack attached. Ensure that the wire rack is correctly positioned on the universal pan. → "Accessories" on page 11

## Roasting and braising in cookware

It is more convenient to roast and braise meat in cookware. You can take the joint out of the cooking compartment more easily in the cookware, and prepare the sauce in the cookware itself.

Only use cookware which is suitable for use in an oven. Check whether the cookware fits in the cooking compartment.

Glass cookware is most suitable. Place hot glass cookware onto a dry mat after cooking. If the surface is damp or cold, the glass may crack.

Add in a little liquid for roasting if the meat is lean. A covering of approx. ½ cm depth should be applied to the base of any glass cookware.

The amount of liquid is dependent on the type of meat, the cookware material and also on whether or not a lid is used. If preparing meat in an enamelled or dark metal roasting dish, it will need a little more liquid than if cooked in glass cookware.

The steam evaporates in the cookware when roasting. Carefully pour in more liquid if required.

Shiny roasting dishes made from stainless steel or aluminium reflect heat like a mirror and are therefore not particularly suitable. The meat cooks more slowly and will not brown so much. Use a higher temperature and/or a longer cooking time.

Observe the manufacturer's instructions for your roasting cookware.

### Roasting in uncovered cookware

It is best to use a deep roasting tin/dish for roasting poultry and meat. Place the tin/dish onto the wire rack. If you do not have any suitable cookware, use the universal pan.

### Braising in covered cookware

When preparing food with covered cookware, the cooking compartment remains considerably cleaner. Ensure that the lid fits well and closes properly. Place the cookware onto the wire rack.

The distance between the meat and the lid must be at least 3 cm. The meat may rise.

Very hot steam may escape when opening the lid after cooking. Lift the lid at the rear, so that the hot steam can escape away from you.

If necessary, braise the meat first by searing it. Add water, wine, vinegar or a similar liquid to the braising liquid. A covering at least 2 cm deep should be applied to the base of the cookware.

The steam evaporates in the cookware when roasting. Carefully pour in more liquid if required.

## Steam-assisted roasting and braising

Certain dishes become crispier if cooked using steam, and do not dry out as much.

Use uncovered cookware. Cookware must be heat- and steam-resistant.

The joints do not have to be turned.

Use steam-assisted cooking if it is indicated in the settings table. Some dishes turn out best if they are cooked in several stages. These are indicated in the table.

## Steaming

By contrast to the steam assistance function, the steaming function cooks the meat particularly gently, but it does not become crispy on the outside. It remains very succulent. As an alternative, you can also fry pieces of meat quickly before steaming; the cooking time will be reduced.

Larger pieces require a longer heating-up time and a longer cooking time. If you are using several pieces which are the same weight, the heating-up time is increased, and not the cooking time.

Pieces of meat do not need to be turned.

Use the perforated steam container (size XL) and slide the universal pan in underneath. You can also use a glass tray and place this onto the wire rack.

## Recommended setting values

In the table, you can find the ideal heating type for poultry and meat. Temperature and cooking time depend on the quantity, composition and temperature of the food. Different settings ranges are indicated for this reason. Try using the lower values at first. You can increase the temperature next time if necessary.

The setting values are based on the assumption that unstuffed, chilled, ready-to-roast poultry and meat are placed into a cold cooking compartment. By doing so, you can make energy savings of up to 20 per cent. If you preheat the oven, the indicated cooking times will be reduced by several minutes.

In the table, you can find specifications for poultry and meat with default values for the weight. If you wish to prepare heavier poultry or meat, use the lower temperature in every case. If roasting several joints, use the weight of the heaviest piece as a basis for determining the cooking time. The individual pieces should be approximately equal in size.

A general rule: the larger the poultry or piece of meat is, the lower the cooking temperature and the longer the cooking time.

Turn the poultry and meat after approx. ½ to ⅔ of the indicated time.

Remove unused accessories from the cooking compartment. This will achieve the best possible cooking results and energy savings of up to 20 per cent.

Type of heating used:

-  4D hot air

The levels of steam intensity are indicated as numbers in the table:

- 1 = Low
- 2 = Medium
- 3 = High

Dish	Accessories/cookware	Shelf position	Type of heating	Temperature in °C	Steam intensity	Cooking time in mins.
<b>Beef</b>						
Slow roast joint	wire rack	1	⊗	140-150	-	35+40
Slow roast joint, 1,5 kg	wire rack	1	⊗	130-140	1	70-80
					-	40-50
Top side / Top rump	wire rack	1	⊗	160-170	-	30+25
Top side / Top rump	wire rack	1	⊗	170-180	1	100-120
<b>Lamb</b>						
Leg (bone-in)	wire rack	1	⊗	160-170	-	25+25
Leg (bone-in), 1,5 kg	wire rack	1	⊗	180-190	1	80-90
Shoulder (bone-in)	wire rack	1	⊗	160-170	-	25+20
Shoulder (boned and rolled)	wire rack	1	⊗	170-180	-	25+25
Rack of lamb***	wire rack	1	⊗	180-190*	-	15+25
Rack of lamb, each 700 g	wire rack	1	⊗	200	-	20
				170-180	1	25-30
<b>Pork</b>						
Roast joint	wire rack	1	⊗	180-190	-	30+35
Roast joint, 1,5 kg	wire rack	1	⊗	120	3	30
				190-200	-	30
				160-170	1	80-100
Loin joint	wire rack	1	⊗	180-190	-	35+35
Loin joint, 1 kg	wire rack	1	⊗	180-190	-	25-30
				170-180	1	70-80
Belly	wire rack	1	⊗	170-180	-	30+25
Gammon joint	wire rack	1	⊗	160-170	-	30+30
Gammon joint, 1,5 kg	wire rack	1	⊗	170-180	2	100-120
<b>Poultry</b>						
Chicken, whole	wire rack	1	⊗	170-180	-	25+15
Chicken, whole, 1,5kg	wire rack	1	⊗	180-190	2	65-75
Chicken, portion, 200-250 g each**	wire rack	1	⊗	190-200	-	35-45
Chicken, portion, 200-250 g each**	wire rack	2	⊗	200-210	2	35-45
Duck	wire rack	1	⊗	180-190	-	25+20
Duck, 2-3 kg	wire rack	1	⊗	160-170	2	70-90
				170-180	-	30-40
Turkey, crown****	wire rack	1	⊗	150-160	-	20+15
Turkey, crown, 3 kg	cookware, uncovered	1	⊗	140-150	2	100-140
Turkey, thighs	wire rack	1	⊗	170-180	-	25+30
Turkey, whole, 4-8 kg	wire rack	1	⊗	150-160	-	12+12
Turkey, whole, 7 kg	universal pan	1	⊗	140-150	2	120-150
				170-180	-	30-40
<b>Meat dishes</b>						
Meat loaf	cookware, uncovered	1	⊗	170-180	-	20+35

\* Preheat

\*\* skin side down

\*\*\* without fat layer (best and neck), do not turn

\*\*\*\* bone side down, do not turn

Dish	Accessories/cookware	Shelf position	Type of heating	Temperature in °C	Steam intensity	Cooking time in mins.
Meat loaf, 1 kg	cookware, uncovered	1		190-200	1	70-80
<b>Casserole</b>						
Diced meat (beef, pork, lamb), 500 g meat	cookware, covered	1		140*	-	100-120
Braising steak	cookware, covered	1		140	-	65+60
Chicken pieces (boned), 500 g meat	cookware, covered	1		140*	-	90-100
<b>Complete meal</b>						
With beef	wire rack + wire rack	3+1		160, then 200 (Yorkshire Pudding)	-	calculation for meat (see table above) + 15-25 for Yorkshire Pudding
With chicken	wire rack + wire rack	3+1		180	-	calculation for chicken (see table above)
With chicken	wire rack + wire rack	3+1		180	low (steam 0 when Yorkshire Pudding is inserted)	65-75
* Preheat ** skin side down *** without fat layer (best and neck), do not turn **** bone side down, do not turn						

## Tips on roasting and braising

The cooking compartment becomes very dirty.	Prepare your food in an enclosed roasting dish with higher temperature or use the grill tray. You will achieve the best roasting results if you use the grill tray. The grill tray can be bought later as a special accessory.
The roast is too dark and the crackling is burned in places, and/or the roast is too dry.	Check the shelf position and temperature. Select a lower temperature the next time and reduce the roasting time if necessary.
The crackling is too thin.	Increase the temperature or switch on the grill briefly at the end of the roasting time.
The roast looks good but the juices are burnt.	Next time, use a smaller roasting dish and add more liquid if necessary.
The roast looks good but the juices are too clear and watery.	Next time, use a larger roasting dish and add less liquid if necessary.
The meat gets burned during braising.	The roasting dish and lid must fit together well and close properly. Reduce the temperature and add more liquid when braising if necessary.

## Grilling

Here, you can find information on grilling poultry, meat and fish, as well as toast. You can find the ideal settings for certain dishes in the settings tables.

### Grilling with circulated air

Circulated air grilling is very well suited to the preparation of whole poultry, fish, and also meat, e.g. roast pork with crackling.

### Poultry

For duck or goose, pierce the skin on the underside of the wings. This allows the fat to run out.

If using duck breast, score the skin. Do not turn duck breasts.

When you turn poultry, ensure that the breast side or the skin side is underneath at first.

Poultry will turn out particularly crispy and brown if you baste it towards the end of the roasting time with butter, salted water or orange juice.

### Meat

Baste lean meat with fat as required or cover it with strips of bacon.

Score the rind crosswise. If you turn the joint when cooking, ensure that the rind is underneath at first.

When the joint is ready, turn off the oven and allow it to rest for another 10 minutes in the cooking compartment. This allows the meat juices to be better distributed. Wrap the joint in aluminium foil if necessary. The recommended resting time is not included in the cooking time indicated.

### **Fish**

Fish cooked whole does not have to be turned. Place the whole fish into the cooking compartment in swimming position with the dorsal fin facing upwards. Placing half a potato or a small oven-proof container in the stomach cavity of the fish will provide stability.

You can tell when the fish is cooked because the dorsal fin can be removed easily.

### **Roasting on the wire rack**

On the wire rack, poultry and meat will become very crispy on all sides. Roasting on the wire rack is well suited for larger poultry or for multiple pieces at the same time.

Depending on the size and type of the meat, add up to ½ litres of water to the universal pan. Any dripping fat and meat juices will be caught. You can prepare a sauce using these meat juices. In addition, less smoke is generated, and the cooking compartment stays cleaner.

Slide the universal pan into the oven at the indicated shelf position with the wire rack attached. Ensure that the wire rack is correctly positioned on the universal pan. → "Accessories" on page 11

### **Roasting in cookware**

It is more convenient to roast and braise meat in cookware. You can take the joint out of the cooking compartment more easily in the cookware, and prepare the sauce in the cookware itself.

Only use cookware which is suitable for use in an oven. Check whether the cookware fits in the cooking compartment.

Glass cookware is most suitable. Place hot glass cookware onto a dry mat after cooking. If the surface is damp or cold, the glass may crack.

Add in a little liquid if the meat is lean. A covering of approx. ½ cm depth should be applied to the base of any glass cookware.

The quantity of liquid is dependent on the type of meat, the cookware material and also on whether or not a lid is used. If preparing poultry, meat or fish in an enamelled or dark metal roasting dish, it will need a little more liquid than if cooked in glass cookware.

The steam evaporates in the cookware when roasting. Carefully pour in more liquid if required.

Shiny roasting dishes made from stainless steel or aluminium reflect heat like a mirror and are therefore not particularly suitable. The meat cooks more slowly and will not brown so much. Use a higher temperature and/or a longer cooking time.

Observe the manufacturer's instructions for your roasting cookware.

### **Uncovered cookware**

Use a deep roasting tin/dish for roasting meat. Place the tin/dish onto the wire rack. If you do not have any suitable cookware, use the universal pan.

### **Covered cookware**

When cooking with covered cookware, the cooking compartment remains considerably cleaner. Ensure that the lid fits well and closes properly. Place the cookware onto the wire rack.

The distance between the meat and the lid must be at least 3 cm. The meat may rise.

Very hot steam may escape when opening the lid after cooking. Lift the lid at the rear, so that the hot steam can escape away from you.

If necessary, braise the meat first by searing it. Add water, wine, vinegar or a similar liquid to the braising liquid. A covering approx. 1-2 cm deep should be applied to the base of the cookware.

The steam evaporates in the cookware when roasting. Carefully pour in more liquid if required.

Meat can also become crispy in a covered roasting dish. To do so, use a roasting dish with a glass lid and set a higher temperature.

### **Steam-assisted roasting**

Certain foodstuffs will become crispier during steam-assisted cooking. Their surface becomes glossier and they dry out less.

Use uncovered cookware. Cookware must be heat- and steam-resistant.

Use steam-assisted cooking if it is indicated in the settings table. Some dishes turn out best if they are cooked in several stages. These are indicated in the table.

### **Grilling flat pieces**

Flat pieces of poultry, meat and fish, such as steaks, drumsticks and burgers, can be prepared well using the "Grill" heating type. Excellent results are also achieved when grilling toast.

### **Grilling**

Keep the appliance door closed when using the grill. Never grill with the appliance door open.

Place the food to be grilled on the wire rack. In addition, slide the universal pan in at least one shelf position lower, with the slanted edge facing the appliance door. Any dripping fat will be caught.

When grilling, try wherever possible to use pieces of food which are of a similar thickness and weight. This will allow them to brown evenly and remain succulent and juicy. Place the food to be grilled directly onto the wire rack.

Use tongs to turn the pieces of food you are grilling. If you pierce the meat with a fork, the juices will run out and it will become dry.

Do not add salt until after the meat has been grilled. Salt draws water from the meat.



**Notes**

- The grill element switches itself continuously on and off; this is normal. The grill setting determines how frequently this occurs.
- Smoke may be produced when grilling.

**Recommended setting values**

In the table, you can find the ideal heating type for your poultry, meat and fish, in addition to toast. Temperature and cooking time depend on the quantity, composition and temperature of the food. Settings ranges are indicated for this reason. Try using the lower values at first. You can use a higher setting next time if necessary.

The setting values are based on the assumption that unstuffed, chilled, ready-to-roast poultry, meat and fish are placed into a cold cooking compartment.

In the table, you can find specifications for poultry, meat and fish with default values for the weight. If you wish to prepare heavier poultry, meat or fish, use the lower temperature in every case. If roasting several joints, use the weight of the heaviest piece as a basis for



determining the cooking time. The individual pieces should be approximately equal in size.

A general rule: the larger the poultry, meat or fish is, the lower the cooking temperature and the longer the cooking time.

Turn the poultry, meat and fish after approx. 1/2 to 2/3 of the indicated time.













Remove unused accessories from the cooking compartment. This will achieve the best possible cooking results and energy savings of up to 20 per cent.

Types of heating used:

-  Circulated air grilling
-  Grill, large area

The levels of steam intensity are indicated as numbers in the table:

- 1 = Low
- 2 = Medium
- 3 = High

Dish	Accessories	Shelf position	Type of heating	Temperature in °C / Grill setting	Steam intensity	Cooking time in mins.
<b>Beef</b>						
Steaks, height 2-3 cm	wire rack	2		3	-	1st side 8-10 2nd side 5-7
Burger, height 1-2 cm	wire rack	2		3*	-	1st side 6-8 2nd side 4-6
Top side / Top rump	wire rack	2		150-160	-	30+30
<b>Lamb</b>						
Steaks, height 2-3 cm	wire rack	2		3*	-	1st side 8-10 2nd side 4-6
Chops, height 2-3 cm	wire rack	2		3	-	1st side 6-8 2nd side 6-8
Leg (bone-in)	wire rack	1		170-180	-	25+30
Leg (bone-in), 1,5 kg	wire rack	1		170-180	1	80-90
Shoulder (bone-in)	wire rack	1		170-190	-	25+15
Shoulder (boned and rolled)	wire rack	1		170-180	-	20+15
Rack of lamb	wire rack	1		190-200	-	15+25
<b>Pork</b>						
Steaks, height 2 cm	wire rack	3		2	-	1st side 12-14 2nd side 6-8
Chops, height 2-3 cm	wire rack	2		3*	-	1st side 10-12 2nd side 9-10
Burger, height 1-2 cm	wire rack	2		3*	-	1st side 6-8 2nd side 4-6

\* Preheat

\*\* Preheat 3 minutes

\*\*\* Preheat 5 minutes

\*\*\*\* Preheat 3 minutes, turn over several times

\*\*\*\*\* Skin side down

Dish	Accessories	Shelf position	Type of heating	Temperature in °C / Grill setting	Steam intensity	Cooking time in mins.
Bacon rashers	wire rack	2		3***	-	1st side 4-5 2nd side 3-4
Sausages, thickness 2-4 cm	wire rack	2		3****	-	10-15
Roast joint	wire rack	1		180-200	-	30-40
Loin joint	wire rack	1		170-180	-	35+35
Belly	wire rack	1		200-220	-	30+25
Belly, 1 kg	wire rack	1		170-180 190-200	1 -	50-60 25-35
Gammon joint	wire rack	2		180-200	-	30+25
<b>Poultry</b>						
Chicken drumstick, 150 g each	wire rack	2		210-230	-	20-30
Chicken drumstick, 150 g each	wire rack	2		210-220	2	30-40
Chicken breast, boned, 150 g each	wire rack	2		3**	-	1st side 10-15 2nd side 10-15
Chicken breast, boned, 150 g each	wire rack	2		200-210	2	20-30
Chicken, whole	wire rack	1		200-220	-	25+15
Chicken, whole, 1,5 kg	wire rack	1		180-190	2	65-75
Chicken, portion, 200-250 g each****	wire rack	2		200-220	-	30-45
Chicken, portion, 200-250 g each****	wire rack	2		200-210	2	35-45
Duck, 2-3 kg	wire rack	1		190-200	-	20+20
Duck, 2-3 kg	wire rack	1		150-160	2	100-120
Turkey thighs	wire rack	1		180-190	-	25+30
Turkey, whole, 4-8 kg	wire rack	1		140-160	-	12+12
<b>Fish</b>						
Trout, whole, 300 g each	wire rack	1		170-190	-	20-30
Fillets, each 150 g	wire rack	2		1**	-	1st side 5-10 2nd side 5-10
<b>Toast</b>						
Grilling white bread	wire rack	3		3	-	2-6
* Preheat ** Preheat 3 minutes *** Preheat 5 minutes **** Preheat 3 minutes, turn over several times ***** Skin side down						

## Convenience products

Here, you can find the ideal settings for preparing chilled and frozen food.

Only use original accessories supplied with your appliance. These have been tailored to the cooking compartment and the operating modes of your appliance.

## Tips

- The cooking result greatly depends on the quality of the food. Pre-browning and unevenness may already be present on the packaged product.
- Do not use frozen products that are heavily frosted. Remove any ice on the food.
- Distribute foods which are in pieces, such as bread rolls and potato products, so that they are spread flat and evenly on the accessories. Leave a little space between the individual pieces.
- Observe the instructions on the packaging.

## Steam- assisted baking

Certain types of baked item (e.g. yeast-risen pastries) get a more crispy crust and a more glossy surface if baked with the steam assist mode. The baked item does not dry out as much.

Steam-assisted baking is only possible on one level.

## Shelf positions

Use the indicated shelf positions.

### Baking on one level

When baking on one level, use the following shelf position:

- Level 1

### Baking on two levels

Use 4D hot air. Baked items that are placed into the oven on trays or in baking tins/dishes at the same time will not necessarily be ready at the same time.

- Universal pan: Level 3  
Baking tray: Level 1

## Accessories

Ensure that you always use suitable accessories and that they are placed in the oven the right way around.

### Wire rack

Insert the wire rack with the open side facing the appliance door and the curved lip pointing downwards. Always place ovenware, tins and dishes on the wire rack.

### Universal pan or baking tray

Slide the universal pan or the baking tray in carefully as far as the limit stop with the bevelled edge facing the appliance door.

### Greaseproof paper

Only use greaseproof paper that is suitable for the selected temperature. Always cut greaseproof paper to size.

## Recommended setting values

In the table, you can find the ideal heating type for various dishes. Temperature and cooking time depend on the quantity and composition of the product. Setting ranges are indicated for this reason. Try using the lower values at first. A lower temperature results in more even browning. You can use a higher setting next time if necessary.





**Note:** Cooking times cannot be reduced by using higher temperatures. The dish would only be cooked on the outside, but would not be fully cooked in the middle.

The setting values apply to dishes placed into a cold cooking compartment. By doing so, you can make energy savings of up to 20 per cent. If you preheat the oven, the indicated cooking times will be reduced by several minutes.

Preheating is necessary for selected dishes, and this is indicated in the table.











Remove unused accessories from the cooking compartment. This will achieve the best possible cooking results and energy savings of up to 20 per cent.

Types of heating used:

-  4D hot air
-  Top/bottom heating
-  Pizza setting
-  coolStart function

The levels of steam intensity are indicated as numbers in the table:

- 1 = Low
- 2 = Medium
- 3 = High

Dish	Accessories/cookware	Shelf position	Type of heating	Temperature in °C	Steam intensity	Cooking time in mins.
<b>Pizza, chilled</b>						
Pizza, chilled	wire rack	1		210-230	-	10-20
<b>Pizza, frozen</b>						
Pizza, thin base*	wire rack	1		-	-	-
Pizza, thin base, 2 levels	2 wire racks	3+1		200-220	-	15-25
Pizza, thick base*	wire rack	1		-	-	-
Pizza, thick base, 2 levels	2 wire racks	3+1		160-180	-	25-35
Pizza baguette	wire rack	1		200-220	-	20-30
<b>Potatoe products, frozen</b>						
Oven chips*	baking tray	1		-	-	-
Oven chips, 2 levels**	universal pan + baking tray	3+1		200-220	-	30-40
Croquettes*	baking tray	1		-	-	-
Hash browns*	universal pan	2		-	-	-
Potatoe wedges*	baking tray	1		-	-	-

\* Observe information on the packaging

\*\* Turn during cooking

Dish	Accessories/cookware	Shelf position	Type of heating	Temperature in °C	Steam intensity	Cooking time in mins.
<b>Baked goods, frozen, prebaked</b>						
Rolls, baguettes*	universal pan	2	☰*	-	-	-
Rolls, baguettes	universal pan	2	☰	180-200	1	15-25
Rolls, baguettes, 2 levels	grid + universal pan	3+1	☰☰	160-180	-	15-25
<b>Fried food, frozen</b>						
Fish fingers*	baking tray	1	☰*	-	-	-
Chicken nuggets*	universal pan	2	☰*	-	-	-
<b>Food, chilled</b>						
Lasagna, 500 g	ovenproof dish on wire rack	1	☰	180-200	-	30-40
Lasagna, 500 g	ovenproof dish on wire rack	1	☰☰	180-190	2	30-40
Lasagna, 1,5 kg	ovenproof dish on universal pan	1	☰☰	180-200	-	35-45
Lasagna, 1,5 kg	ovenproof dish on wire rack	1	☰☰	160-170	2	35-45
<b>Food, frozen</b>						
Lasagna, 500 g*	ovenproof dish on universal pan	1	☰*	-	-	-
Lasagna, 500 g	ovenproof dish on wire rack	1	☰☰	180-190	2	40-50
Lasagna, 1,5 kg	ovenproof dish on universal pan	1	☰☰	160-180	-	60-80
Lasagna, 1,5 kg	ovenproof dish on wire rack	1	☰☰	160-170	2	45-55
* Observe information on the packaging						
** Turn during cooking						

## Steaming

Only use original accessories. When steaming in the perforated steam container (size XL), always slide the universal pan in underneath as well. Dripping liquid is caught.

### Steaming on one level

Use the shelf positions indicated in the settings tables.

### Steaming on two levels

Steaming on two levels is very well suited to simultaneously cooking broccoli and potatoes, for example. In cases where the cooking times are different, insert the foodstuff with the shorter cooking time later.

- Wire rack and attached steam container (size S), perforated and/or unperforated: Level 3
- Perforated steam container (size XL): Level 2

### Cookware

If you use cookware, place it onto the wire rack or the perforated steam container, size XL.

Ovenware must be heat and steam resistant. Cooking times are increased when using cookware with thick edges.

Food which would normally be prepared in a water bath should always be covered with foil.

### Cooking time and quantity

Cooking times when steaming are dependent on the size of the pieces, but not dependent on the total quantity. If a larger total quantity is used, the heating-up time is increased and not the cooking time.

Larger pieces require a longer heating-up time and a longer cooking time. If you are using several pieces which are the same weight, the heating-up time is increased, and not the cooking time.

Observe the unit sizes indicated in the settings table. The cooking time is reduced for smaller pieces and increased for larger ones. Cooking time is also influenced by the quality and ripeness of the food. This means that the setting values indicated are purely guidelines.

Always distribute the food evenly in the cookware. It will not cook evenly if the layers are of different depths. When layering delicate foods in the cooking container, do not pile them too high. It is better to use two containers.

### Rice and cereals

Add water or liquid in the proportion indicated. E.g. "1:1.5" means adding 150 ml liquid per 100 g rice.

### Menu cooking

With your appliance you can cook a whole menu at once without the different flavours or aromas mixing with each other.

Place the food with the longest cooking time in the appliance first and add the rest at the appropriate time. This means that all the food will be ready at the same time.

The overall cooking time is extended with menu cooking, as a little steam escapes each time the appliance door is opened and has to be reheated.

Observe the information in the relevant paragraphs of this section:

- The heating-up time varies depending on the size and weight of the food
- The cooking time does not depend on the quantity
- Use cookware that is steam-resistant
- Cover soufflé with foil
- Always insert the universal pan at level 1

**Shelf positions for accessories**

Always insert accessories in the following order:

- Level 3: Wire rack with steam container, size S
- Level 2: Steam container, size XL
- Level 1: Universal pan

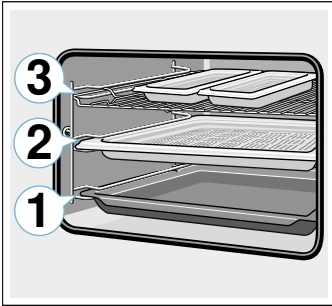

**Making rice pudding**

1. Weigh the rice and add 2.5 times as much milk.
2. Fill a bowl with the rice and milk so that the mixture is max. 2.5 cm deep.  
You can also use the universal pan for large quantities.

3. Use the settings indicated in the table.
4. Stir after cooking.  
The remaining milk is quickly absorbed.

**Compote**

Weigh the fruit and add approx. 1/3 as much water. Add sugar and spices to taste. Use the settings indicated in the table.

**Crème caramel and soufflé**

Place the small dishes directly into the perforated steam container (size XL). A water bath is not required. Use the settings indicated in the table.

Food which would normally be prepared in a water bath should always be covered with foil.

**Dampfnudeln (steamed bread rolls)**



































Prepare the yeast dough according to your recipe without cooking. Place the shaped balls into a greased, perforated steam container (size XL), and allow them to prove. Use the settings indicated in the table.

**Recommended setting values**

Type of heating used:

- Steaming

Dish	Accessories/cookware	Shelf position	Type of heating	Temperature in °C	Cooking time in mins.
<b>Poultry</b>					
Chicken breast, 150 g each	steam container	2		100	15-25
<b>Pork</b>					
Pork fillet, 400 g	steam container	2		100	18-20
<b>Fish</b>					
Fish, whole 300 g, e.g. trout	steam container, perforated	2		80-90	15-25
Fish, whole 1,5 kg, e.g. cod	steam container, perforated	2		80-90	35-50
Fish fillet, 200 g	steam container, perforated	2		80-100	10-16
<b>Fish, frozen</b>					
Fish, whole 300 g, e.g. trout	steam container, perforated	2		80-100	20-25
<b>Fish dishes</b>					
Fish terrine	bain marie	2		70-80	45-80
<b>Potatoes</b>					
Unpeeled boiled potatoes	steam container, perforated	2		100	35-45
Boiled potatoes, quartered	steam container, perforated	2		100	20-25
<b>Vegetables, fresh</b>					
Artichokes, whole	steam container, perforated	2		100	30-35
Cauliflower, whole	steam container, perforated	2		100	25-35
Broccoli, florets	steam container, perforated	2		100	6-9
Green beans	steam container, perforated	2		100	18-25

Dish	Accessories/cookware	Shelf position	Type of heating	Temperature in °C	Cooking time in mins.
Carrots, slices	steam container, perforated	2		100	10-20
Cabbage turnip, slices	steam container, perforated	2		100	17-20
Leek, slices	steam container, perforated	2		100	6-9
Sweetcorn, whole	steam container, perforated	2		100	30-40
Beetroot, whole	steam container, perforated	2		100	43-50
White asparagus, whole	steam container, perforated	2		100	7-15
Spinach	steam container, perforated	2		100	2-3
Courgette, slices	steam container, perforated	2		100	3-4
<b>Vegetables, frozen</b>					
Cauliflower	steam container, perforated	2		100	15-25
Green beans	steam container, perforated	2		100	5-8
Broccoli	steam container, perforated	2		100	6-10
Peas	steam container, perforated	2		100	6-10
Carrots	steam container, perforated	2		100	3-10
Brussel sprouts	steam container, perforated	2		100	4-6
Mixed vegetables, 1 kg	steam container, perforated	2		100	5-10
<b>Rice</b>					
Basmati rice, 1:1,5	cookware, flat	1		100	10-15
Long-grain rice, 1:1,5	cookware, flat	1		100	20-30
Brown rice, 1:1,5	cookware, flat	1		100	30-40
Parboiled rice, 1:1,5	cookware, flat	1		100	15-20
Risotto, 1:2	cookware, flat	1		100	25-35
<b>Cereals</b>					
Couscous, 1:1	cookware, flat	1		100	6-10
Millet, whole, 1:1,25	cookware, flat	1		100	25-35
Polenta, 1:5	cookware, flat	1		100	20-45
<b>Egg</b>					
Hard-boiled eggs	steam container, perforated	2		100	9-11
Soft-boiled eggs	steam container, perforated	2		100	6-8
<b>Dessert</b>					
Crème Brulée	individual moulds	1		85	20-30
Crème caramel	individual moulds	1		85	25-35
Soufflé	individual moulds	1		100	40-45
Yeast dumplings	universal pan	1		100	25-30
Rice pudding, 1:2,5	universal pan	1		100	25-35
Fruit compote, 1/3 water	universal pan	1		100	10-20
<b>Complete meal</b>					
Frozen salmon fillet	steam container, solid, size S	3		100	20
Broccoli, florets	steam container, perforated, size XL	2		100	9
Potatoes boiled	steam container, perforated, size S	3		100	25

## Yogurt

You can make your own yogurt using your appliance.

### Preparing yogurt

Remove accessories and shelves from the cooking compartment. The cooking compartment must be empty.

1. Heat 1 litre of milk (3.5 % fat) to 90 °C on the hob and then cool down to 40 °C.  
It is sufficient to heat UHT milk to 40 °C.
2. Stir in 150 g (chilled) yogurt.

3. Pour into cups or small jars and cover with cling film.
4. Place the cups or jars onto the cooking compartment floor and use the settings indicated in the table.
5. After preparation, leave the yogurt to cool in the refrigerator.

Type of heating used:

-  Proving dough

Dish	Cookware	Shelf position	Type of heating	Temperature in °C	Cooking time in hours
Yoghurt	individual moulds	cooking compartment floor		35-40	5-6

## Eco types of heating

Hot air eco and Top/bottom heating eco are intelligent heating types for the gentle preparation of meat, fish and pastries. The appliance optimally controls the supply of energy to the cooking compartment. The food is prepared in phases using residual heat. This means that it remains more succulent and browns less. Energy can be saved, depending on the preparation and food.

Place the food into the empty cooking compartment before it has heated up. Always keep the appliance door closed when cooking.

Remove unused accessories from the cooking compartment. This will allow you to achieve optimum cooking results and save energy.

Only use original accessories supplied with your appliance. These have been tailored to the cooking compartment and the operating modes of your appliance.

### Accessories

Ensure that you always use suitable accessories and that they are placed in the oven the right way around.

#### Wire rack

Slide the wire rack in with the embossed "microwave" facing the appliance door, and the curved lip pointing downwards. Always place ovenware, tins and dishes on the wire rack.

#### Universal pan or baking tray

Slide the universal pan or the baking tray in carefully as far as the limit stop with the bevelled edge facing the appliance door.

### Baking tins and cookware

Dark- coloured metal baking tins are most suitable. These allow you to make energy savings of up to 35 per cent.

Cookware made from stainless steel or aluminium reflects heat like a mirror. Non-reflective cookware made from enamel, heat-resistant glass or coated, die-cast aluminium is more suitable.

Tinplate baking tins, ceramic dishes or glass dishes prolong baking time, and the cake will not brown so evenly.

### Greaseproof paper

Only use greaseproof paper that is suitable for the selected temperature. Always cut greaseproof paper to size.







### Recommended setting values















Here, you can find specifications for various dishes. The temperature and baking time are dependent on the quantity and composition of the dough. Different settings ranges are indicated for this reason. Try using the lower values at first. A lower temperature results in more even browning. If necessary, use a higher setting the next time.

**Note:** Baking times can not be reduced by using higher temperatures. Cakes or baked items would only be cooked on the outside, but would not be cooked completely in the middle.

Types of heating used:

-  Hotair Eco
-  Top/bottom heating Eco

Dish	Accessories/cookware	Shelf position	Type of heating	Temperature in °C	Cooking time in mins.
<b>Baking</b>					
Victoria sponge cake	2x Ø20 cm tins	1		170-180	25-35
Light fruit cake	high Ø20 cm tin	1		150-170	70-90
Rich Fruit Cake	high Ø23 cm tin	1		140-160	120-180
Fruit crumble	flat glass dish	1		160-180	40-60
Sponge cake (fatless), 3 eggs	springform cake tin, Ø26 cm	1		160-170	25-35
Swiss Roll	swiss roll tin	1		180-200	10-20

Dish	Accessories/cookware	Shelf position	Type of heating	Temperature in °C	Cooking time in mins.
Fruit Pie	plate Ø20 cm or pie tin	1		170-190	60-75
Quiche	quiche tin (dark coated)	1		190-210	35-45
(White) Bread	loaf tin (1x 900 g or 2x 450 g)	1		190-200	45-55
Scones	baking tray	1		190-210	15-20
Biscuits	baking tray	2		140-160	15-30
Jam tarts	12-cup-tin	1		170-190	15-30
Soufflé	1,2 L-soufflé dish	1		160-170	40-50
Meat Pie	rectangular pie tin	1		190-210	40-55
Jacket potatoes	baking tray	2		150-170	60-90
<b>Meat</b>					
Beef, slow roast joint	wire rack	1		140+150	35+40
<b>Casserole</b>					
Diced meat (beef, pork, lamb), 500 g meat	cookware, covered	1		140	100-120
Braising steak	cookware, covered	1		140	65+60
<b>Fish</b>					
Fish, braised, whole 300 g, e.g. trout	cookware, covered	1		190-210	25-35
Fish, braised, whole 1,5 kg, e.g. salmon	cookware, covered	1		190-210	45-55
Fish fillet, plain, braised, 100 g	cookware, covered	1		190-210	15-35

## Acrylamide in foodstuffs

Acrylamide is mainly produced in grain and potato products prepared at high temperatures, such as potato

crisps, chips, sliced bread, bread rolls, bread or fine baked goods (biscuits, gingerbread, spiced biscuit).

### Tips for keeping acrylamide to a minimum

General	<ul style="list-style-type: none"> <li>■ Keep cooking times as short as possible.</li> <li>■ Cook food until it is golden brown, but not too dark.</li> <li>■ Large, thick pieces of food contain less acrylamide.</li> </ul>
Baking	With top/bottom heating at max. 200 °C. With hot air at max. 180 °C.
Biscuits	With top/bottom heating at max. 190 °C. With hot air at max. 170 °C. Egg or egg yolk reduces the production of acrylamide.
Oven chips	Spread out a single layer evenly on the baking tray. Cook at least 400 g at once on a baking tray so that the chips do not dry out.

## Slow cook

Slow cooking is a technique for cooking food over a long period at low temperatures. For this reason, it is also called "low-temperature cooking".

Slow cooking is ideal for all prime cuts (e.g. tender portions of beef, veal, pork, lamb or poultry) which are to be cooked "à point". The meat will remain succulent and tender.

The benefit of this cooking method is that it allows lots of scope for menu planning because slow-cooked meat is easy to keep warm. You do not have to turn the meat when cooking. Keep the appliance door closed in order to maintain an even cooking climate.

Only use fresh, clean and hygienic meat without bones. Carefully remove sinews and fat from around the edge. Fat develops a strong, distinct flavour during slow cooking. You can also use seasoned or marinated meat. Do not use defrosted meat.

Meat can be carved immediately following slow cooking. No standing time is required. Due to the special cooking method, the meat looks pink, but is not raw or undercooked.

**Note:** Delayed-start operation with an end time is not possible for the slow cooking heating type.



## Cookware

Use flat cookware, e.g. a glass/porcelain serving dish. Place the cookware into the cooking compartment to preheat it.

Always place the uncovered cookware onto the wire rack at level 1.

You can find additional information in the tips on slow cooking attached to the settings table.

Your appliance features the heating type "Slow cook". Only start operation when the cooking compartment has fully cooled down. Allow the cooking compartment to warm up for around 10 minutes with the cookware inside.

















Sear the meat on the hotplate at a very high heat and for a sufficiently long time on all sides, even on the ends. Place into the preheated cookware right away. Place the cookware containing the meat into the cooking compartment once again and cook slowly.

## Recommended setting values

The slow cooking temperature and cooking time are dependent on the size, thickness and quality of the meat. Different settings ranges are indicated for this reason.

Type of heating used:

-  Slow cooking

Dish	Cookware	Shelf position	Type of heating	Searing time in mins.	Temperature in °C	Cooking time in mins.
<b>Poultry</b>						
Duck breast, 400 g	Cookware, uncovered	1		6-8	90*	45-60
Chicken breast fillet, 200 g each	Cookware, uncovered	1		5-7	90*	45-60
Turkey breast, boned, 1 kg	Cookware, uncovered	1		8-10	90*	120-150
<b>Pork</b>						
Pork tenderloin steak, 5-6 cm thick, 1.5 kg	Cookware, uncovered	1		8-10	85*	210-240
Fillet of pork, whole	Cookware, uncovered	1		6-8	85*	60-90
Pork medallions, 4 cm thick	Cookware, uncovered	1		5-7	85*	90-120
<b>Beef</b>						
Joint of beef (rump), 6-7 cm thick, 1.5 kg	Cookware, uncovered	1		8-10	85*	240-300
Beef tenderloin, whole, 1 kg	Cookware, uncovered	1		4-6	85*	120-180
Sirloin, 5-6 cm thick	Cookware, uncovered	1		6-8	85*	210-270
Beef medallions/rump steak, 4 cm thick	Cookware, uncovered	1		5-7	85*	60-120
<b>Veal</b>						
Joint of veal, 4-5 cm thick, 1.5 kg	Cookware, uncovered	1		8-10	85*	180-240
Joint of veal, 10-15 cm thick, 1.5 kg	Cookware, uncovered	1		8-10	85*	240-300
Veal fillet, whole, 800 g	Cookware, uncovered	1		5-7	85*	150-210
Veal medallions, 4 cm thick	Cookware, uncovered	1		5-7	85*	90-120
<b>Lamb</b>						
Saddles of lamb, boneless, 200 g each	Cookware, uncovered	1		5-7	85*	45-75
Leg of lamb, boned, medium, 1 kg, tied	Cookware, uncovered	1		6-8	85*	180-240

\* Preheat

## Tips for slow cooking

Slow-cooking duck breast.

Place the cold duck breast into a pan and fry the skin side first. After slow cooking, grill for 3 to 5 minutes until crispy.

The slow-cooked meat is not as hot as conventionally roasted meat.

So that the roasted meat does not cool so quickly, warm the plates and serve the sauces very hot.

## Drying

With 4D hot air, you can dry foods with outstanding results. With this type of preserving, flavourings are concentrated by the dehydration.

Only use unblemished fruit, vegetables and herbs and wash them thoroughly. Line the wire rack with greaseproof paper or parchment paper. Drain the excess water from the fruit and dry it.

If necessary, cut it into equal chunks or thin slices. Place unpeeled fruit onto the dish with the sliced surfaces facing upwards. Ensure that neither fruit nor mushrooms overlap on the wire rack.

Grate vegetables and then blanch them. Allow the blanched vegetables to drain off and distribute them evenly on the wire rack.

Dry herbs on the stem. Position the herbs evenly and slightly heaped on the wire rack.

Use the following shelf positions when drying:

- 1 wire rack: Level 2
- 2 wire racks: Level 3+1

Dish	Accessories	Shelf position	Type of heating	Temperature in °C	Cooking time in hours
Pomes (apple rings, 3 mm thick, 200 g per wire rack)	Wire rack	2	☉	80	4-7
Stone fruit (plums)	Wire rack	2	☉	80	8-10
Root vegetables (carrots), grated, blanched	Wire rack	2	☉	80	4-7
Sliced mushrooms	Wire rack	2	☉	60	6-8
Herbs, washed	1-2 wire racks	-	☉	60	2-6

## Preserving and juicing

Your appliance is also suitable for preserving and juicing.

### Preserving

You can preserve fruit and vegetables using your appliance.

#### Warning – Risk of injury!

If the food is preserved incorrectly, the preserving jars may burst. Follow the instructions for preserving.

### Jars

Use only clean and undamaged preserving jars. Only use heat-resistant, clean and undamaged rubber rings. Check clips and clamps in advance.

**Tip:** You can use the disinfecting function to clean the jars.

For each preserving process, only use preserving jars that are the same size and contain the same food. In the cooking compartment, you can preserve the contents of a maximum of six ½, 1 or 1½-litre preserving jars at the same time. Do not use jars that are larger or taller than this. The lids could rupture.

Preserving jars must not touch one another in the cooking compartment during the preserving process.

Turn very juicy fruit and vegetables several times. After drying, remove the dried products from the paper immediately.

### Recommended setting values

In the table, you can find settings for drying various foodstuffs. The temperature and cooking time are dependent on the type, moisture, ripeness and thickness of the food to be dried. The longer you leave the food to be dried, the better it will be preserved. The thinner the slices are, the quicker the drying process will be and the more aromatic the dried food will remain. Setting ranges are indicated for this reason.

If you wish to dry additional foodstuffs, you should use similar foodstuffs in the table as a reference.

Type of heating used:

- ☉ 4D hot air

### Preparing fruit and vegetables

Only use fruit and vegetables that are in good condition. Wash them thoroughly.

Peel, core and chop fruit and vegetables appropriate to their type and fill the preserving jars with them up to approx. 2 cm below the rim.

Fruit: Fill the preserving jars with the fruit along with a hot, skimmed sugar solution (approx. 400 ml for a 1-litre jar). For one litre of water:

- Approx. 250 g sugar for sweet fruit
- Approx. 500 g sugar for sour fruit

Vegetables: Fill the jars with the vegetables along with hot, boiled water.

Wipe the rims of the jars, as they must be clean. Place a damp rubber ring and a lid on each jar. Seal the jars with clamps. Place the jars into the perforated steam container (size XL) so that they do not touch each other. Pour 500 ml hot water (approx. 80 °C) into the universal pan. Use the settings indicated in the table.

### Ending the preserving process

After the specified cooking time, open the appliance door. Do not remove the preserving jars from the cooking compartment until they have completely cooled down.

Wipe the cooking compartment clean afterwards.

## Juicing

Before juicing, place the berries in a bowl and sprinkle with sugar. Leave to stand for at least one hour to draw out the juice.

Then fill the perforated steam container (size XL) with the berries and insert into the oven at level 2. Slide the universal pan in underneath to collect any juice. Use the settings indicated in the table.

After cooking, wrap the berries in a cloth and squeeze out the remaining juice.





Wipe the cooking compartment clean afterwards.

## Recommended setting values

The times indicated in the settings table are guideline values for preserving fruit and vegetables and for juicing fruit. They may be influenced by room temperature, number of jars, quantity, heat and the quality of the jar contents. The specifications are based on 1-litre round jars.

Type of heating used:

-  Steaming

Dish	Accessories/cookware	Shelf position	Type of heating	Temperature in °C	Cooking time in mins.
<b>Preserving</b>					
Vegetables, e.g. carrots	1-litre preserving jars + XL steam container	1		100	30-120
Stone fruit, e.g. cherries, damsons	1-litre preserving jars + XL steam container	1		100	25-30
Pomes, e.g. apples, strawberries	1-litre preserving jars + XL steam container	1		100	25-30
<b>Juicing</b>					
Raspberries	Steam container	2		100	30-45
Redcurrants	Steam container	2		100	40-50

## Sterilising bottles and hygiene

Using your appliance, you can very easily sterilise cookware and baby feeding bottles. The process corresponds to normal sterilisation by boiling.

### Sterilising bottles

Always clean the bottles with a bottle brush immediately after use. Then clean them in the dishwasher.

Place the bottles into the steam container, size XL, so that they do not touch each other. Start the programme "Sterilising". After sterilising, wipe the appliance down inside. Dry the bottles with a clean cloth after sterilising.

## Hygiene

Your appliance is also suitable for preparing jam jars or preserving jars and their corresponding lids.

Post-treatment of jam is also possible. This improves the storage life of the jam.



## Recommended setting values

Only use clean, intact jars and lids. They should ideally be cleaned in the dishwasher in advance. Cookware must be heat- and steam-resistant.

The recommended times are dependent on the jars used.

Type of heating used:

-  Steaming

Dish	Accessory	Shelf position	Type of heating	Temperature in °C	Cooking time in mins.
<b>Hygiene</b>					
Preparing jam jars or preserving jars	XL steam container	1		100	10-15
Post-treating jam jars	XL steam container	1		100	15-20
Sterilising clean cookware*	XL steam container	1		100	15-20

\* This process corresponds to normal sterilisation by boiling.

## Proving dough

Dough will prove considerably more quickly using the "Dough proving" heating type than at room temperature and does not dry out. Only start operation when the cooking compartment has fully cooled down.

Always allow yeast dough to prove twice. Observe the specifications in the settings tables for the 1st and 2nd proving processes (dough fermentation and final fermentation).

### Dough fermentation

Position the dough bowl on the wire rack for the dough fermentation. Use the settings indicated in the table.

Do not open the appliance door during the proving process, as moisture will escape. Do not cover the dough.

### Final fermentation

Place your baked item into the oven at the shelf position indicated in the table.





Wipe moisture from the cooking compartment before baking.

### Recommended setting values

The temperature and proving time are dependent on the type and quantity of the ingredients. The values in the table are therefore only meant to be average values.

Type of heating used:

-  Proving dough

Dish	Accessories/cookware	Shelf position	Type of heating	Step	Temperature in °C	Cooking time in mins.
<b>Yeast dough, sweet</b>						
E.g. small baked items	Bowl	1		Dough fermentation	35-40	30-45
	Universal pan	1		Final fermentation	35-40	10-20
Rich dough, e.g. panettone	Bowl	1		Dough fermentation	35-40	20-40
	Tin on wire rack	1		Final fermentation	35-40	10-20
<b>Yeast dough, savoury</b>						
E.g. pizza	Bowl	1		Dough fermentation	40-45	40-90
	Universal pan	1		Final fermentation	40-45	30-60
<b>Bread dough</b>						
White bread	Bowl	1		Dough fermentation	35-40	30-40
	Universal pan	1		Final fermentation	35-40	15-25
Multigrain bread	Bowl	1		Dough fermentation	35-40	25-40
	Universal pan	1		Final fermentation	35-40	10-20
Bread rolls	Bowl	1		Dough fermentation	35-40	30-40
	Universal pan	1		Final fermentation	35-40	15-25

## Defrosting

The steam function "Defrost" is suitable for defrosting frozen fruit and vegetables. Use heating type 4D hot air to defrost baked items. Poultry, meat and fish should ideally be defrosted in the refrigerator.

Remove frozen food from any packaging when defrosting it.

Place frozen fruit and vegetables into the perforated steam container (size XL) and slide the universal pan in underneath. This means that the food does not remain in the meltwater and that any dripping liquid will be caught. Use the universal pan or cookware on the wire rack for frozen food where liquid should remain in the dish, e.g. frozen creamed spinach.



Place the baked item onto the wire rack.





### Recommended setting values

The times in the table are average values. They are dependent on the quality, freezing temperature (-18 °C) and composition of the food. Time ranges are indicated. Set the shortest time first and then increase the time if necessary.

**Tip:** Items which were frozen flat or portioned defrost faster than those frozen in a block.

Types of heating used:

-  4D hot air
-  Defrosting

Dish	Accessories	Shelf position	Type of heating	Temperature in °C	Cooking time in mins.
<b>Bread, bread rolls</b>					
General	Baking tray	1		50	40-70
<b>Cake</b>					
Cake, moist	Baking tray	1		50	70-90
Cake, dry	Baking tray	1		60	60-75
<b>Fruit, vegetables</b>					
Berries	Steam container	2		30-40	10-15
Vegetables	Steam container	2		40-50	15-50

### Reheating

Using heating type "Reheating", food is reheated gently using steam. It tastes and looks as though it has been freshly prepared. Even baked items from the day before can be re-crisped.

Use containers which are as flat, wide and heat-resistant as possible. Cold containers prolong the reheating process.

Where possible, only reheat dishes of the same size and type at the same time. If this is not possible, the time required for the component with the longest reheating time should be used as a basis.

Do not cover food while it is being reheated.

Place the food in the cookware onto the wire rack or place it directly onto the wire rack at level 1.

Do not open the appliance door during operation, as a lot of steam will escape.

### Recommended setting values







In the table, you can find the ideal settings for various dishes. The times specified are only average values. They are dependent on the cookware used, the quality, temperature and consistency of the food. Time ranges are indicated. Set the shortest time first and then extend the time if necessary.

The values in the table apply to dishes placed into a cold cooking compartment. Preheating is necessary for selected dishes, and this is indicated in the table.





Remove unused accessories from the cooking compartment. This will allow you to achieve ideal cooking results and save energy.

Type of heating used:

-  Reheating

Dish	Accessories/cookware	Shelf position	Type of heating	Temperature in °C	Cooking time in mins.
<b>Vegetables, chilled</b>					
1 kg	Cookware, uncovered	1		120-130	15-25
250 g	Cookware, uncovered	1		120-130	5-15
<b>Dishes, chilled</b>					
Plated meal, 1 portion	Cookware, uncovered	1		120-130	15-25
Soup, stew, 400 ml	Cookware, uncovered	1		120-130	10-25
Side dishes, e.g. pasta, dumplings, potatoes, rice	Cookware, uncovered	1		120-130	8-25
Bakes, e.g. lasagne, potato gratin	Cookware, uncovered	1		120-140	10-25
Pizza, cooked	Wire rack	1		170-180*	5-15

\* Preheat

Dish	Accessories/cookware	Shelf position	Type of heating	Temperature in °C	Cooking time in mins.
<b>Baked goods</b>					
Bread rolls, baguette, baked	Wire rack	1		150-160*	10-20
Pastries (vol-au-vents)	Wire rack	1		180*	4-10
<b>Baked goods, frozen</b>					
Pizza, cooked	Wire rack	1		170-180*	5-15
Bread rolls, baguette, baked	Wire rack	1		160-170*	10-20
* Preheat					

## Keeping warm

You can keep cooked dishes warm using the "Keeping warm" heating type. You can use the various moisture levels to prevent the cooked dishes from drying out.

Do not cover the food.

Do not keep cooked dishes warm for longer than two hours. Be aware that some dishes may continue cooking whilst being kept warm. Do not cover the food.

The various steam levels are suitable for keeping the following foods warm:

- Level 1: Roasted joints and pan-fried foods
- Level 2: Bakes and side dishes
- Level 3: Stews and soups

## Test dishes

These tables have been produced for test institutes to facilitate the inspection of the appliance.

In accordance with EN 60350-1:2013 and IEC 60350-1:2011.

## Baking

Baked items that are placed into the oven on trays or in baking tins/dishes at the same time will not necessarily be ready at the same time.

Shelf positions for baking on two levels:

- Universal pan: Level 3
- Baking tray: Level 1

## Apple pie



Apple pie on one level: place dark-coloured springform cake tins diagonally next to each other.

Cakes in tinplate springform cake tins: bake on one level with top/bottom heating. Place the springform cake tin onto the universal pan instead of onto the wire rack.

## Notes







- The setting values apply to dishes placed into a cold cooking compartment.
- Please note the information in the tables about preheating. The setting values are valid without rapid heating-up.
- For baking, use the lower of the indicated temperatures first.

Types of heating used:

-  4D hot air
-  Top/bottom heating
-  Pizza setting

The levels of steam intensity are indicated as numbers in the table:

- 1 = Low
- 2 = Medium
- 3 = High

Dish	Accessories/cookware	Shelf position	Type of heating	Temperature in °C	Steam intensity	Cooking time in mins.
<b>Baking</b>						
Shortbread	Baking tray	1		150-160*	-	25-40
Shortbread	Baking tray	1		140-150*	-	25-35
Shortbread, 2 levels	Universal pan + baking tray	3+1		140-150*	-	30-40
Small cakes	Baking tray	1		160*	-	25-35
Small cakes	Baking tray	1		150*	-	25-35
Small cakes, 2 levels	Universal pan + baking tray	3+1		150*	-	25-35
Fatless sponge cake	Springform cake tin, diameter 26 cm	1		160-170**	-	25-35
* Preheat for 5 mins, do not use quick heat function						
** Preheat, do not use quick heat function						

Dish	Accessories/cookware	Shelf position	Type of heating	Temperature in °C	Steam intensity	Cooking time in mins.
Fatless sponge cake	Springform cake tin, diameter 26 cm	1		160-170**	-	25-35
Fatless sponge cake	Springform cake tin, diameter 26 cm	1		150-160	1	10
					-	20-30
Apple pie	2 x black plate tins, diameter 20 cm	1		180-200	-	60-70
Apple pie	2 x black plate tins, diameter 20 cm	1		170-180	-	60-80

\* Preheat for 5 mins, do not use quick heat function  
 \*\* Preheat, do not use quick heat function

**Steam**

Slide the universal pan in under the perforated steam container (size XL) if indicated in the table. Any dripping liquid is caught.

Shelf positions for steaming on one level (use a maximum of 2.5 kg):

- Perforated steam container (size XL): Level 2

Shelf positions for steaming on two levels (use a maximum of 1.8 kg per level):

- Perforated steam container (size XL): Level 3
- Perforated steam container (size XL): Level 2

Type of heating used:

- Steaming

Dish	Accessories	Shelf position	Type of heating	Temperature in °C	Cooking time in mins.
<b>Steam</b>					
Peas, frozen, two containers, 1.8 kg each	XL steam container x 2 + universal pan	3+2+1		100	3-15**
Broccoli, fresh, 300 g	XL steam container	2		100*	6-7***
Broccoli, fresh, one container	XL steam container	2		100*	6-7***

\* Preheat  
 \*\* Test is over when 85°C is reached at the coldest spot (see IEC 60350-1)  
 \*\*\* A comparable degree of cooking between reference sample and main sample is achieved if the reference sample is cooked for 5 minutes (produced as described in IEC 60350-1).

**Grilling**

Also slide in the universal pan. The liquid will be caught and the cooking compartment stays cleaner.

Type of heating used:

- Grill, large area

Dish	Accessories	Shelf position	Type of heating	Grill setting	Cooking time in mins.
<b>Grilling</b>					
Browning toast	Wire rack	3		3	2-6
Beefburgers, x 12*	Wire rack	2		3	20-30

\* Turn after 2/3 of the total time

BSH Hausgeräte GmbH  
Carl-Wery-Str. 34  
81739 München, GERMANY

[siemens-home.com](http://siemens-home.com)

Manufactured by BSH Hausgeräte GmbH under Trademark License of Siemens AG



9000943495  
960524