



EH...FD..

Hob

SIEMENS

EH...FD..

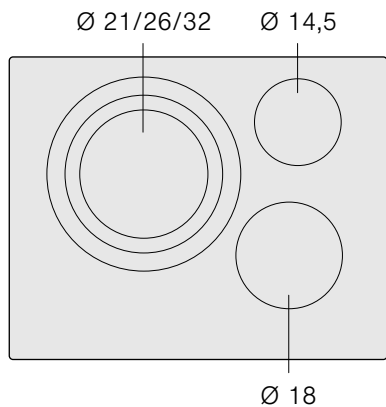

		g*	b*
Ø 21/26/32		2.200 W	3.300 W
		2.600 W	3.400 W
		3.300 W	max. 4.600 W
Ø 14,5		1.400 W	1.800 W
Ø 18		1.800 W	2.800 W

* IEC 60335-2-6

en Table of contents

Safety precautions	3	To deactivate	9
Elements that may damage the appliance	4	Time programming function	9
Protecting the environment	5	Turning off a hotplate automatically	9
Environmentally-friendly disposal.....	5	The timer.....	10
Energy-saving advice	5	Cleaning lock function	10
Induction cooking	5	Automatic time limitation	10
Advantages of induction cooking	5	Displaying energy consumption	10
Cookware	5	Basic settings	11
Getting to know your appliance	6	Accessing the basic settings.....	12
The control panel.....	6	Care and cleaning	12
The hotplates	6	Hob.....	12
Residual heat indicator	6	Hob frame	12
Programming the hob	7	Fixing malfunctions	12
Turning the hob on and off	7	Normal noise while the appliance is working.....	13
Setting the hotplate	7	After-sales service	13
Cooking guidelines table.....	7	Tested dishes	14
Childproof lock	9		
Activating and deactivating the childproof lock.....	9		
Childproof lock	9		
Powerboost function	9		
Restrictions when using.....	9		
To activate.....	9		

Additional information on products, accessories, replacement parts and services can be found at www.siemens-home.com and in the online shop www.siemens-eshop.com

Safety precautions

Please read this manual carefully. Please keep the instruction and installation manual as well as the appliance certificate in a safe place for later use or for subsequent owners.

Check the appliance after removing it from the packaging. If it has suffered any damage in transport, do not connect the appliance, contact the Technical Assistance Service and provide written notification of the damage caused, otherwise you will lose your right to any type of compensation.

This appliance must be installed according to the installation instructions included.

This appliance is intended for domestic use only. The appliance must only be used for the preparation of food and drink. The appliance must be supervised during operation. Only use this appliance indoors.

Do not use covers. These can cause accidents, due to overheating, catching fire or materials shattering, for example.

Do not use inappropriate child safety shields or hob guards. These can cause accidents.

This appliance is not intended for operation with an external clock timer or a remote control.

This appliance may be used by children over the age of 8 years old and by persons with reduced physical, sensory or mental capabilities or by persons with a lack of experience or knowledge if they are supervised or are instructed by a person responsible for their safety how to use the appliance safely and have understood the associated hazards.

Children must not play with, on, or around the appliance. Children must not clean the appliance or carry out general maintenance unless they are at least 8 years old and are being supervised.

Keep children below the age of 8 years old at a safe distance from the appliance and power cable.

We advise that you exercise caution using or standing near an induction hob while it is in operation, if you wear a pacemaker or a similar medical device. Consult your doctor or the device manufacturer concerning its conformity or any possible incompatibilities,

Risk of fire!

- Hot oil and fat can ignite very quickly. Never leave hot fat or oil unattended. Never use water to put out burning oil or fat. Switch off the hotplate. Extinguish flames carefully using a lid, fire blanket or something similar.
- The hotplates become very hot. Never place combustible items on the hob. Never place objects on the hob.
- The appliance gets hot. Do not keep combustible objects or aerosol cans in drawers directly underneath the hob.
- The hob switches off automatically and can no longer be operated. It may switch on unintentionally at a later point. Switch off the circuit breaker in the fuse box. Contact the after-sales service.

Risk of burns!

- The hotplates and surrounding area (particularly the hob surround, if fitted) become very hot. Never touch the hot surfaces. Keep children at a safe distance.
- The hotplate heats up but the display does not work. Switch off the circuit breaker in the fuse box. Contact the after-sales service.
- Metal objects on the hob quickly become very hot. Never place metal objects (such as knives, forks, spoons and lids) on the hob.
- After each use, always turn off the hob at the main switch. Do not wait until the hob turns off automatically after the pan is removed.

Risk of electric shock!

- Incorrect repairs are dangerous. Repairs may only be carried out and damaged power cables replaced by one of our trained after-sales technicians. If the appliance is defective, unplug the appliance from the mains or switch off the circuit breaker in the fuse box. Contact the after-sales service.

- Do not use any high-pressure cleaners or steam cleaners, which can result in an electric shock.
- A defective appliance may cause electric shock. Never switch on a defective appliance. Unplug the appliance from the mains or switch off the circuit breaker in the fuse box. Contact the after-sales service.
- Cracks or fractures in the glass ceramic may cause electric shocks. Switch off the circuit breaker in the fuse box. Contact the after-sales service.

Malfunction risk!

The hob is equipped with a fan in the lower section. If there is a drawer under the hob it should not be used to store small objects or paper, since they could damage the fan or interfere with the cooling if they are sucked into it.

There should be a minimum of 2 cm between the contents of the drawer and fan intake.

Risk of injury!

- When cooking in a bain marie, the hob and cooking container could shatter due to overheating. The cooking container in the bain marie must not directly touch the bottom of the water-filled pot. Only use heat-resistant cookware.
- Saucepans may suddenly jump due to liquid between the pan base and the hotplate. Always keep the hotplate and saucepan bases dry.

Elements that may damage the appliance

Caution!

- Rough pan bases may scratch the hob.
- Avoid leaving empty pots and pans on the hotplate. Doing so may cause damage.
- Do not place hot pans on the control panel, the indicator area, or the hob frame. Doing so may cause damage.
- Hard or pointed objects dropped on the hob may damage it.
- Aluminium foil and plastic containers will melt if placed on the hotplate while it is hot. The use of laminated sheeting is not recommended on the hob.

Overview

The following table presents the most common damage caused:

Damage	Cause	Measure
Stains	Food spillage	Immediately remove spilt food using a glass scraper.
	Unsuitable cleaning products	Only use cleaning products specifically designed for glass-ceramic hobs.
Scratches	Salt, sugar and sand	Do not use the hob as a tray or working surface.
	Pans with rough bottoms may scratch the glass ceramic	Check pans.
Fading	Unsuitable cleaning products	Only use cleaning products specifically produced for glass-ceramic hobs.
	Contact with pans	Lift pots and pans before moving them around.
Chips	Sugar, substances with a high sugar content	Immediately remove spilt food using a glass scraper.

Protecting the environment

Environmentally-friendly disposal

Dispose of packaging in an environmentally-friendly manner.



This appliance is labelled in accordance with European Directive 2012/19/EU concerning used electrical and electronic appliances (waste electrical and electronic equipment - WEEE). The guideline determines the framework for the return and recycling of used appliances as applicable throughout the EU.

Energy-saving advice

- Always use the correct lid for each pan. Cooking without a lid uses a lot more energy. Use a glass lid to provide visibility and avoid having to lift the lid.

- Use pans with flat bases. Bases that are not flat use a lot more energy.
- The diameter of the pan base must match the size of the hotplate. Please note: pan manufacturers usually provide the diameter for the top of the pan, which is usually larger than the diameter of the pan base.
- Use a small pan for small amounts of food. A large pan which is not full uses a lot of energy.
- Use little water when cooking. This saves energy and preserves all the vitamins and minerals in vegetables.
- Select the lowest power level to maintain cooking. If the power level is too high, energy is wasted.

Induction cooking

Advantages of induction cooking

Induction cooking represents a radical change from the traditional method of heating; the heat is generated directly in the pan. It therefore offers a number of advantages:

- Time savings for cooking and frying; since the pan is heated directly.
- Energy is saved.
- Care and cleaning are simpler. Foods that have spilt do not burn as quickly.
- Heat and safety control; the hob supplies or cuts off power as soon as the control knob is turned on. The induction hotplate stops supplying heat if the pan is removed without having previously switched it off.

Cookware

Only ferromagnetic pans are suitable for induction cooking; these may be made from:

- enamelled steel
- cast iron
- special stainless steel induction pans.

To determine whether a pan is suitable, check to see if a magnet will stick to its base.

There are other types of cookware for induction whose base is not entirely ferromagnetic.

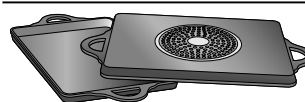

When using large cookware on a smaller ferromagnetic area, only the ferromagnetic zone heats up, so heat might not be uniformly distributed.

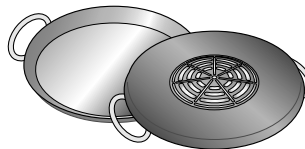

Pans with aluminium areas inserted in the base reduce the ferromagnetic area, so less heat may be supplied and the pan may be difficult to detect or not be detected at all.

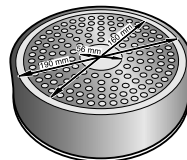

For good cooking results, the diameter of the cookware's ferromagnetic area should match the size of the hotplate. If cookware is not detected on a hotplate, try it on the next smaller hotplate down.

Unsuitable pans

Never use diffuser hobs or pans made from:

- common thin steel
- glass
- earthenware
- copper
- aluminium

Characteristics of the pan base

The characteristics of the pan base may affect the uniformity of the cooking results. Pans made from materials which help diffuse heat, such as stainless steel sandwich pans, distribute heat uniformly, saving time and energy.

Absence of pan or unsuitable size

If no pan is placed on the selected hotplate, or if it is made of unsuitable material or is not the correct size, the power level displayed on the hotplate indicator will flash. Place a suitable pan on the hotplate to stop the flashing. If this takes more than 90 seconds, the hotplate will switch off automatically.

Empty pans or those with a thin base

Do not heat empty pans, nor use pans with a thin base. The hob is equipped with an internal safety system. However, an empty pan may heat up so quickly that the "automatic switch off" function may not have time to react and the pan may reach

very high temperatures. The base of the pan could melt and damage the glass on the hob. In this case, do not touch the pan and switch the hotplate off. If it fails to work after it has cooled down, please contact the Technical Assistance Service.

Pan detection

Each hotplate has a minimum limit for detecting pans, which varies depending on the material of the pan being used. You should therefore use the hotplate that is most suitable for the diameter of your pan.

Automatic detection on double or triple hotplates

These hotplates can detect cookware of different sizes. Depending on the material and properties of the cookware, the hotplate will adapt automatically, switching on part or all of the hotplate and supplying sufficient power to obtain good cooking results.

Getting to know your appliance

The instruction manual is the same for various different hobs. An overview of the models with their dimensions is given on page 2.

The control panel

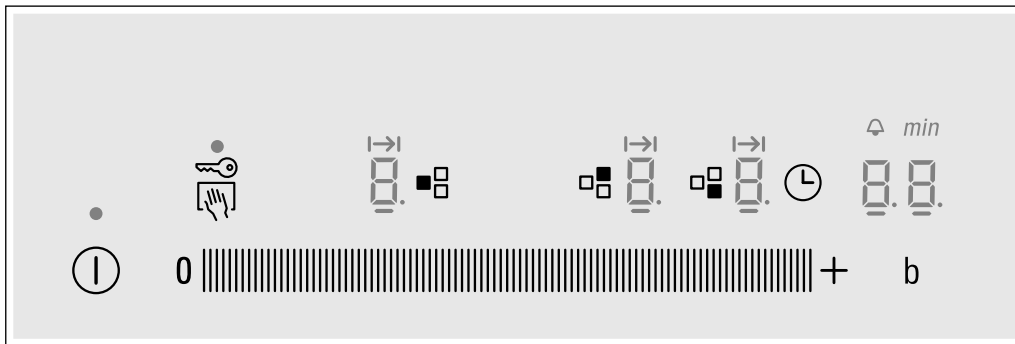

Control panels	
ⓘ	Main switch
■□	Selecting the hotplate
0 +	Programming zone
b	Powerboost Function
⌚	Timer programming
🔑	Childproof lock
🧼	Cleaning lock function

Indicators	
1-9	Power levels
0	Functionality
H/h	Residual heat
b	Powerboost Function
⌚	Timer
⏪	Automatic shut-off

Control panels

Pressing a symbol activates its corresponding function.

Note: Always keep the control surfaces dry. Moisture can affect proper working.

The hotplates

Hotplate	
○ Single hotplate	Use correctly-sized cookware.
⊗ Triple hotplate	The hotplate is switched on automatically by using a pan with a base that matches the size of the outer area (⊗ or ⊙) selected for use.

Only use pans suitable for induction cooking; see the "Suitable cookware" section.

Residual heat indicator

The hob has a residual heat indicator for each hotplate to show those which are still hot. Avoid touching them when this indicator is lit.

Although the hob is switched off, the indicator *h* or *H* will remain on for as long as the hotplate is hot.



If the pan is removed before the hotplate is turned off, the indicator *h* or *H* and the selected power level will appear alternately.

Programming the hob

This section will show you how to program the hotplates. The table contains power levels and cooking times for several dishes.

Turning the hob on and off

The hob is turned on and off using the main switch.

To turn on: Press the  symbol. A beep sounds. The indicator located next to the main switch and the  indicators of the hotplates light up. The hob is ready for use.

To turn off: press the  symbol until the indicators go out. All hotplates are turned off. The residual heat indicator will remain lit until the hotplates have cooled down sufficiently.

Notes

- The hob switches off automatically when all the hotplates are switched off for more than 20 seconds.
- The settings are memorised for 4 seconds after the hob has been turned off. If the hotplate is switched back on within this time then the previous settings will be applied.

Setting the hotplate

The desired power level is set in the programming panel.



Power level 1 = minimum power.

Power level 9 = maximum power.

Each power level has an intermediate setting. This is marked with a dot.

Selecting the hotplate and the power level

The hob must be switched on.

1. Select the hotplate with the  symbol.
The  symbol lights up in the display.

2. Within the next 10 seconds, slide a finger over the programming zone until the desired power level lights up.

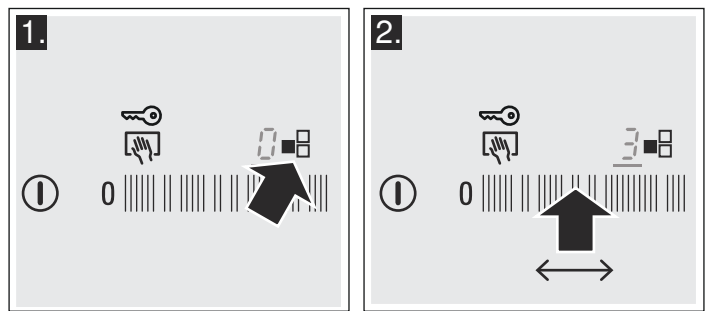

The power level has been set.

Changing the power level

Select the hotplate and set the desired power level in the programming zone.

Switch off the hotplate

Select the hotplate and set it to  in the programming panel. The hotplate turns off and the residual heat indicator appears.

Notes

- If no pan has been placed on the hotplate, the selected power level flashes. After a certain time has elapsed, the hotplate switches off.
- If a pan has been placed on the hotplate before switching on the hob, it will be detected within 20 seconds of pressing the main switch and the hotplate will be selected automatically. Once detected, select the power level within the next 20 seconds or the hotplate will switch off.
If more than one pan is placed on the hob, only one will be detected when switching it on.

Cooking guidelines table

The table below contains some examples.

Cooking times depend on the power level, type, weight and quality of the food. As such they are approximate.

When heating purées, creams and thick sauces, stir occasionally.

Use power level 9 to begin cooking.

	Power level	Cooking time
Melting		
Chocolate, chocolate coating	1-1.	-
Butter, honey, gelatin	1-2	-
Heating and keeping warm		
Stew (e.g., lentils)	1.-2	-
Milk**	1.-2.	-
Sausages heated in water**	3-4	-
Defrosting and heating		
Frozen spinach	3-4	15-25 min.
Frozen goulash	3-4	30-40 min.

* Uncovered cooking

** Uncovered

*** Turn frequently

	Power level	Cooking time
Slow cooking, simmering		
Potato dumplings*	4-5.	20-30 min.
Fish*	4-5	10-15 min.
White sauces (e.g., bechamel)	1-2	3-6 min.
Whipped sauces (e.g., Bearnaise, Hollandaise)	3-4	8-12 min.
Boiling, steaming, sautéing		
Rice (with a double amount of water)	2-3	15-30 min.
Rice pudding	2-3	30-40 min.
Unpeeled potatoes	4-5	25-30 min.
Peeled potatoes with salt	4-5	15-25 min.
Pasta*	6-7	6-10 min.
Soups	3-4.	15-60 min.
Vegetables	2-3.	10-20 min.
Greens, frozen foods	3-4.	7-20 min.
Cooked in a pressure cooker	4-5.	-
Stewing		
Meat roll	4-5	50-60 min.
Stew	4-5	60-100 min.
Goulash	3-4	50-60 min.
Bake / Fry with a little oil**		
Steaks, plain or breaded	6-7	6-10 min.
Frozen steaks	6-7	8-12 min.
Chops, plain or breaded***	6-7	8-12 min.
Beefsteak (3 cm thick)	7-8	8-12 min.
Chicken breast (2 cm thick)***	5-6	10-20 min.
Frozen chicken breast***	5-6	10-30 min.
Hamburgers, meatballs (3 cm thick)***	4-5.	30-40 min.
Plain fish and fish fillet	5-6	8-20 min.
Breaded fish and fish fillet	6-7	8-20 min.
Frozen breaded fish (e.g., fish fingers)	6-7	8-12 min.
Prawns and shrimps	7-8	4-10 min.
Frozen meals (e.g., stir-fries)	6-7	6-10 min.
Pancakes	6-7	fry individually
Omelette	3-4.	fry individually
Fried eggs	5-6	3-6 min.
Frying** (150-200 g per serving with 1-2 l of oil)		
Frozen foods (e.g., French fries, chicken nuggets)	8-9	fry one portion at a time
Frozen croquettes	7-8	
Meat (e.g., chicken pieces)	6-7	
Fish, in breadcrumbs or batter	6-7	
Greens, mushrooms, in breadcrumbs or batter (e.g., baby mushrooms)	6-7	
Confectionery products (e.g., fritters, fruit in batter)	4-5	

* Uncovered cooking

** Uncovered



*** Turn frequently

Childproof lock

The hob can be protected against being accidentally turned on, to ensure that children do not switch on the hotplates.

Activating and deactivating the childproof lock

The hob should be turned off.

To activate: press the symbol  for approximately 4 seconds. The indicator next to the symbol  lights up for 10 seconds. The hob is locked.

To deactivate: press the symbol  for approximately 4 seconds. The lock is now deactivated.

Childproof lock

With this function, the childproof lock automatically activates when a hob is switched off.



Activating and deactivating

All of the relevant information on the automatic childproof lock connection can be found in the *Basic settings* chapter.

Powerboost function

The Powerboost function can be used to heat large amounts of water more quickly than the power level 5.



Restrictions when using

This function is available on all hotplates, provided that no other zone in the same group is working (see diagram). Otherwise, the  and  symbols will flash on the selected hotplate display; then the power level 5 will be automatically set.

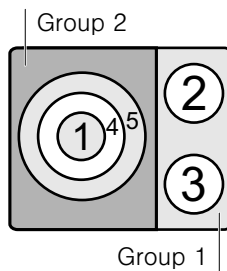
In group 2, the Powerboost function may be activated at the same time for all hotplates (see diagram).





To activate

1. Select a hotplate.
2. Press the  symbol.
The  indicator lights up.

The function will have been activated.

To deactivate

1. Select the hotplate.
2. Press the  symbol.

The  indicator will disappear and the hotplate will return to power level 5.

The Powerboost function will have been deactivated.

Note: In certain circumstances, the Powerboost function may turn off automatically in order to protect the electronic components inside the hob.

Time programming function

This function may be used in two different ways:



- to automatically switch off a hotplate.
- as a timer.

Turning off a hotplate automatically

The zone turns off automatically once the selected time has elapsed.

Program the cooking time.

The hob must be switched on:

1. Select the desired hotplate and power level.
2. Press the  symbol. The  indicator on the hotplate lights up.  lights up in the time program function display.

3. Within the next 10 seconds, select the desired cooking time in the programming zone. The possible default setting is, from left to right: 1, 2, 3, etc., up to 10 minutes.

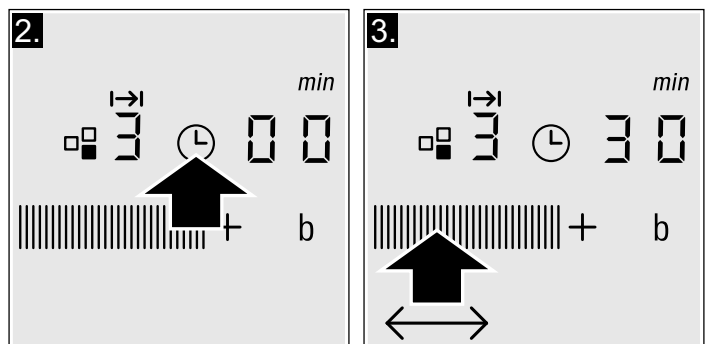

After a few seconds, the cooking time begins to elapse.

Note: The same cooking time can be automatically programmed for the all the hotplates. The programmed time passes independently for each of the hotplates.

The *Basic settings* chapter provides information on automatically programming the cooking time.

Automatic programming

If the previous setting from 1 to 5 is pressed in the programming zone, the cooking time is reduced by one minute.

If the previous setting from 6 to 10 is pressed in the programming zone, the cooking time is increased by one minute.

Changing or cancelling the time

Select the hotplate and then press the ⌚ symbol.

Change the cooking time using the programming zone or set to 00 in order to cancel the time.

Once the time has elapsed

The hotplate switches off. A warning signal sounds. The time program function lights up 00 for 10 seconds in the display.

When the ⌚ symbol is pressed, the indications turn off and the beeping stops.

Notes

- If cooking times have been programmed for various hotplates, the time programming function always displays the time for the selected hotplate.
- Any cooking time can be programmed for up to 99 minutes.

The timer

The timer can be set for periods of up to 99 minutes. It is independent of the other settings. This function does not automatically switch off a hotplate.

Programming

1. Press the ⌚ symbol several times until the ⚠ indicator lights up. 00 lights up in the time program function display.

2. Select the desired time in the programming panel.

The timer starts to count down after a few seconds.

Changing or cancelling the time

Press the ⌚ symbol several times until the ⚠ indicator lights up. Change the time with the programming zone, or set to 00.

Once the time has elapsed

A warning signal sounds. In the time program function display 00 is shown, and the ⚠ indicator lights up. After 10 seconds the indicators turn off.

When the ⌚ symbol is pressed, the indicators turn off and the beeping stops.

Cleaning lock function

Cleaning the control panel while the hob is switched on may change the settings.

In order to avoid this, the hob has a cleaning lock function. Press the 🔒 symbol. A signal sounds. The control panel is

locked for 35 seconds. The control panel surface can now be cleaned without the risk of changing the settings.

Note: The lock does not affect the main switch. The hob may be turned off when desired.

Automatic time limitation

If the hotplate remains in use for a long time and no changes are made in the settings, the automatic time limitation function is triggered.

The hotplate stops heating. The F, B symbol and the residual heat indicator h/H flash alternately in the display.

The indicator goes out when any symbol is pressed. The hotplate can now be reset.

When the automatic time function is used, it is governed by the selected power level (from 1 to 10 hours).

Displaying energy consumption

This function displays total energy consumption for the time the hob has been switched on.

After switching off the hob, the consumption in kWh is displayed for 10 seconds.

An example is shown in the image with a consumption of 1.08 kWh.

The *Basic Settings* chapter provides information on activating this function.



Basic settings

The device has several basic settings. These settings may be adapted to the user's individual needs.

Indicator	Function
<i>c 1</i>	Childproof lock <i>0</i> Deactivated.* <i>1</i> Activated.
<i>c 2</i>	Audible signals <i>0</i> Confirmation and error signals deactivated. <i>1</i> Only error signal activated. <i>2</i> Only confirmation signal activated. <i>3</i> All signals activated.*
<i>c 3</i>	Display energy consumption <i>0</i> Deactivated.* <i>1</i> Activated.
<i>c 5</i>	Automatic programming of cooking time. <i>0</i> Switched off.* <i>1-99</i> Automatic shut-off time.
<i>c 6</i>	Duration of the time program function warning signal <i>1</i> 10 seconds*. <i>2</i> 30 seconds. <i>3</i> 1 minute.
<i>c 7</i>	Power-Management function <i>0</i> = Deactivated.* <i>1</i> = 1,000 W. minimum power. <i>1</i> = 1,500 W. <i>2</i> = 2,000 W. etc. <i>9</i> or <i>9</i> . = maximum power of the hob.
<i>c 9</i>	Hotplate time selection <i>0</i> Unlimited: the last hotplate programmed remains selected.* <i>1</i> Limited: The hotplate will only remain selected for 10 seconds.
<i>c 0</i>	Return to basic settings <i>0</i> Personal settings.* <i>1</i> Return to factory settings.

*Factory settings

Accessing the basic settings

The hob should be turned off.

1. Switch on the hob using the main switch.
2. Within the next 10 seconds, press and hold the  symbol for 4 seconds.

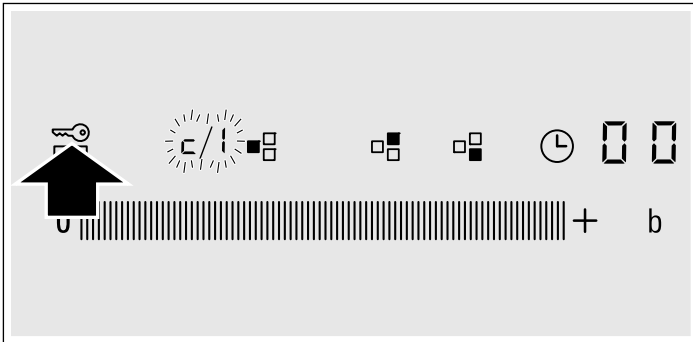

In the display **c** and **i** alternately light up and **0** lights up as a default setting.

3. Press the  symbol several times until the desired function indicator appears.
4. Then select the desired setting with the programming zone.



5. Press and hold the  symbol again for more than 4 seconds.

The settings will have been correctly saved.

Quit

To leave the basic settings, turn off the hob at the main switch.

Care and cleaning

The advice and warnings contained in this section aim to guide you in cleaning and maintaining the hob, so that it is kept in the best possible condition

Hob

Cleaning

Clean the hob after each use. This prevents food remains left on the surface from burning. Wait until the hob is cool enough before attempting to clean it.

Only use cleaning products specifically designed for hobs. Follow the instructions provided on the packaging.

Do not use:

- Undiluted washing-up liquid
- Dishwasher detergent
- Abrasive products

- Corrosive products such as oven sprays or stain removers
- Sponges that may scratch
- High-pressure or steam cleaners

The best way to remove stubborn stains is to use a glass scraper. Follow the manufacturer's instructions.

Suitable glass scrapers can be obtained through the Technical Assistance Service or from our online shop.

Hob frame

In order to avoid damage to the hob frame, follow the indications below:

- Use only slightly soapy hot water
- Do not use sharp or abrasive products
- Do not use a glass scraper

Fixing malfunctions

Malfunctions are usually due to small details. Before calling the Technical Assistance Service you should bear in mind the following advice and warnings.

Indicator	Malfunction	Solution
none	The electric power supply has been cut off. The appliance has not been correctly connected following the connection diagram. Electronic system malfunction.	Use other electrical appliances to check whether there has been a power cut. Check that the appliance has been connected correctly according to the connection diagram. If none of the above checks resolve the malfunction, contact the Technical Assistance Service.
The indicators flash	The control panel is damp or an object is resting on it.	Dry the control panel area or remove the object.
The indicator - flashes on the hotplate indicators	A fault has occurred in the electronic system.	Briefly cover the control panel with your hand to confirm the malfunction.

* If the warning persists call the Technical Assistance Service.

Do not rest hot pans on the control panel.

Indicator	Malfunction	Solution
<i>E</i> + number / <i>d</i> + number / <i>E</i> + number	Electronic system malfunction.	Unplug the hob from the mains. Wait about 30 seconds before plugging it in again.*
<i>F0</i> / <i>F9</i>	There is an internal operating error.	Unplug the hob from the mains. Wait about 30 seconds before plugging it in again.*
<i>F2</i>	The electronic system has overheated and the corresponding hotplate has been switched off.	Wait until the electronic system has cooled down sufficiently. Then press any symbol on the hob. *
<i>F4</i>	The electronic system has overheated and all hotplates have been switched off.	
<i>F5</i> + power level and beep	There is a hot pan on the control panel. It is highly likely that the electronic system will overheat.	Remove that pan. The malfunction indicator will switch off shortly afterwards. You can carry on cooking.
<i>F5</i> and beep	There is a hot pan on the control panel. The hotplate has switched off to protect the electronic system.	Remove that pan. Wait a few seconds. Press any control panel. When the malfunction indicator switches off, you can carry on cooking.
<i>U1</i>	Incorrect supply voltage, outside normal operating limits.	Contact your electricity board.
<i>U2</i> / <i>U3</i>	The hotplate has overheated and has switched off in order to protect its hob.	Wait until the electronic system has cooled down sufficiently before switching it back on.

* If the warning persists call the Technical Assistance Service.

Do not rest hot pans on the control panel.

Normal noise while the appliance is working

Induction heating technology is based on the creation of electromagnetic fields that generate heat directly at the base of the pan. Depending on how the pan has been manufactured, certain noises or vibrations may be produced such as those described below:

A deep humming sound as in a transformer

This noise is produced when cooking with a high power level. It is caused by the amount of energy transferred from the hob to the pan. The noise disappears or becomes faint when the power level is lowered.

A low whistling sound

This noise is produced when the pan is empty. The noise disappears when water or food is added to the pan.

A crackling sound

This noise occurs in pans which are made from different materials superimposed on one another. It is caused by the vibrations that occur in the adjoining surfaces of the different superimposed materials. The noise comes from the pan. The amount of food and cooking method can vary noise intensity.

A high-pitched whistling sound

This noise is produced mainly in pans made from different materials superimposed on one another, and it occurs when such pans are heated at maximum power on two hotplates at the same time. The whistling disappears or becomes fainter as soon as the power level is lowered.

Noise from the fan

For proper use of the electronic system, the temperature of the hob must be controlled. To do this, the hob has a fan which turns on when a high temperature is detected. The fan may also work by inertia after the hob has been switched off, if the temperature detected is still too high.

The noises described are normal, they are part of induction heating technology and not a sign of malfunction.

After-sales service

Our after-sales service is there for you if your appliance should need to be repaired. We are committed to find the best solution also in order to avoid an unnecessary call-out.

E number and FD number:

Please quote the E number (product number) and the FD number (production number) of your appliance when contacting the after-sales service. The rating plate bearing these numbers can be found on the appliance certificate.

Please note that a visit from an after-sales service engineer is not free of charge, even during the warranty period.

Please find the contact data of all countries in the enclosed customer service list.

To book an engineer visit and product advice

GB 0844 8928999
Calls from a BT landline will be charged at up to 3 pence per minute. A call set-up fee of up to 6 pence may apply.

IE 01450 2655
0.03 € per minute at peak. Off peak 0.0088 € per minute.

Rely on the professionalism of the manufacturer. You can therefore be sure that the repair is carried out by trained service technicians who carry original spare parts for your appliances.

Tested dishes

This table has been prepared for assessment institutions to provide controls for our appliances.

The data in the table refers to our Schulte-Ufer cookware accessories (4 piece cookware set for the HZ 390042 induction hob) with the following measurements:

- Saucepan Ø 16 cm, 1.2 l for hotplates of Ø 14.5 cm
- Pot Ø 16 cm, 1.7 l for hotplates of Ø 14.5 cm
- Pot Ø 22 cm, 4.2 l for hotplates of Ø 18 cm
- Frying pan Ø 24 cm, for hotplates of Ø 18 cm

Tested dishes	Hotplate	Preheating		Cooking		
		Power level	Time (Min:S)	Cover	Power level	Cover
Melting chocolate						
Cookware: saucepan						
Chocolate coating (e.g. Dr. Oetker brand, dark 55%, 150 g.)	Ø 14.5 cm	-	-	-	1 - 1.	No
Heating lentil stew and keeping it heated						
Cookware: Pot						
Initial temperature 20 °C						
<i>Lentil stew*</i>						
Amount 450 g.	Ø 14.5 cm	9	1:30 without stirring	Yes	1.	Yes
Amount: 800 g.	Ø 18 cm	9	2:30 without stirring	Yes	1.	Yes
<i>Canned lentil stew, e.g. Erasco lentils with chorizo</i>						
Amount 500 g.	Ø 14.5 cm	9	1:30 stir after approx. 1:00	Yes	1.	Yes
Amount 1 kg.	Ø 18 cm	9	2:30 stir after approx. 1:00	Yes	1.	Yes
Making bechamel sauce						
Cookware: Saucepan						
Milk temperature: 7 °C						
Ingredients: 40 g of butter, 40 g of flour, 0.5 l of milk (3.5% fat) and a pinch of salt	Ø 14.5 cm					
1. Melt butter, mix in flour and salt and heat everything together		1	approx. 3:00	No		
2. Add milk and bring the sauce to a boil, stirring continuously		7	approx. 5:20	No		
3. Keep the bechamel sauce at a boil for two more minutes, stirring continuously					1	No
Cooking rice pudding						
Cookware: Pot						
Milk temperature: 7 °C						
Heat milk until it begins to bubble. Change the recommended heating level and add rice, sugar and salt to the milk						
Ingredients: 190 g. of short-grain rice, 23 g. of sugar, 750 ml. of milk (3.5% fat) and a pinch of salt	Ø 14.5 cm					
Ingredients: 250 g. of short-grain rice, 30 g. of sugar, 1 l. of milk (3.5% fat) and a pinch of salt	Ø 18 cm	8.	approx. 6:30	No	2 stir after approx. 10:00	Yes
Cooking rice*						
Cookware: Pot						
Water temperature 20 °C						
Ingredients: 125 g of short-grain rice, 300 g of water and a pinch of salt	Ø 14.5 cm	9	approx. 2:30	Yes	2	Yes
Ingredients: 250 g of short-grain rice, 600 g of water and a pinch of salt	Ø 18 cm	9	approx. 2:30	Yes	2.	Yes

*Recipe according to DIN 44550

***Recipe according to DIN EN 60350-2

Tested dishes	Hotplate	Preheating			Cooking	
		Power level	Time (Min:S)	Cover	Power level	Cover
Pan-frying pork sirloin						
Cookware: Frying pan						
Sirloin initial temperature: 7 °C	Ø 18 cm	9	1:30	No	7	No
2 pieces of sirloin (total weight approx. 200 g, 1 cm thick)						
Frying crêpes**						
Cookware: Frying pan						
55 ml of crêpe batter	Ø 18 cm	9	1:30	No	7	No
Frying frozen potato chips						
Cookware: Pot						
Ingredients: 1.8 kg of sunflower oil, for cooking: 200 g of frozen potato chips (e.g. McCain 123 Frites Original)	Ø 18 cm	9	Until the temperature of the oil reaches 180 °C	No	9	No

*Recipe according to DIN 44550

***Recipe according to DIN EN 60350-2

Siemens-Electrogeräte GmbH
Carl-Wery-Straße 34
81739 München
Germany



9000884529 01 940107