

SIEMENS



## Built-in oven

HB55NB550B

[siemens-home.com/welcome](https://siemens-home.com/welcome)

[en] Instruction manual

Register  
your  
product  
online



<b>Important safety information</b> .....	<b>4</b>	<b>After-sales service</b> .....	<b>18</b>
Causes of damage .....	5	E number and FD number .....	18
<b>Your new oven</b> .....	<b>6</b>	<b>Energy and environment tips</b> .....	<b>18</b>
Control panel .....	6	Saving energy.....	18
Buttons and display.....	6	Environmentally-friendly disposal.....	18
Function selector.....	6	<b>Tested for you in our cooking studio</b> .....	<b>18</b>
Temperature selector.....	7	Cakes and pastries .....	18
Temperature indicator.....	7	Baking tips .....	20
Cooking compartment .....	7	Meat, poultry, fish.....	21
<b>Your accessories</b> .....	<b>8</b>	Tips for roasting and grilling.....	24
Inserting accessories .....	8	Preprepared products.....	24
Optional accessories .....	8	Special dishes .....	25
After-sales service products .....	10	Defrost.....	26
<b>Before using for the first time</b> .....	<b>10</b>	Desiccation .....	26
Setting the clock .....	10	<b>Acrylamide in foodstuffs</b> .....	<b>26</b>
Heating up the oven.....	10	<b>Test dishes</b> .....	<b>27</b>
Cleaning accessories.....	10	Baking .....	27
<b>Setting the oven</b> .....	<b>10</b>	Grilling.....	27
Switching on the oven.....	10		
Switching off the oven.....	10		
Rapid heating .....	11		
<b>Setting the time-setting options</b> .....	<b>11</b>		
Timer .....	11		
Cooking time .....	11		
End time.....	12		
Clock .....	12		
<b>Childproof lock</b> .....	<b>13</b>		
Switching on the childproof lock.....	13		
Switching off the childproof lock.....	13		
<b>Changing the basic settings</b> .....	<b>13</b>		
<b>Automatic switch-off</b> .....	<b>13</b>		
The automatic switch-off function is activated.....	13		
Remove automatic switch-off.....	13		
<b>Cleaning system</b> .....	<b>14</b>		
Cleaning levels for the √ main oven .....	14		
Before cleaning .....	14		
Setting .....	14		
After cleaning.....	14		
<b>Care and cleaning</b> .....	<b>14</b>		
Cleaning agents .....	14		
Cleaning the hook-in racks .....	15		
Detaching and attaching the oven door.....	15		
Cleaning the door panels.....	16		
<b>Troubleshooting</b> .....	<b>17</b>		
Malfunction table.....	17		
Replacing the oven light bulb.....	17		
Glass cover .....	17		

---

Additional information on products, accessories, replacement parts and services can be found at [www.siemens-home.com](http://www.siemens-home.com) and in the online shop [www.siemens-eshop.com](http://www.siemens-eshop.com)

## Important safety information

Read these instructions carefully. Only then will you be able to operate your appliance safely and correctly. Retain the instruction manual and installation instructions for future use or for subsequent owners.

This appliance is only intended to be fully fitted in a kitchen. Observe the special installation instructions.

Check the appliance for damage after unpacking it. Do not connect the appliance if it has been damaged in transport.

Only a licensed professional may connect appliances without plugs. Damage caused by incorrect connection is not covered under warranty.

This appliance is intended for domestic use only. The appliance must only be used for the preparation of food and drink. The appliance must be supervised during operation. Only use this appliance indoors.

This appliance is intended for use up to a maximum height of 2000 metres above sea level.

This appliance may be used by children over the age of 8 years old and by persons with reduced physical, sensory or mental capabilities or by persons with a lack of experience or knowledge if they are supervised or are instructed by a person responsible for their safety how to use the appliance safely and have understood the associated hazards.

Children must not play with, on, or around the appliance. Children must not clean the appliance or carry out general maintenance unless they are at least 8 years old and are being supervised.

Keep children below the age of 8 years old at a safe distance from the appliance and power cable.

Always slide accessories into the cooking compartment correctly. See "*Description of accessories*" in the instruction manual.

### **Risk of fire!**

- Combustible items stored in the cooking compartment may catch fire. Never store combustible items in the cooking compartment. Never open the appliance door if there is smoke inside. Switch off the appliance and unplug it from the mains or switch off the circuit breaker in the fuse box.

- A draught is created when the appliance door is opened. Greaseproof paper may come into contact with the heating element and catch fire. Do not place greaseproof paper loosely over accessories during preheating. Always weight down the greaseproof paper with a dish or a baking tin. Only cover the surface required with greaseproof paper. Greaseproof paper must not protrude over the accessories.

### **Risk of burns!**

- The appliance becomes very hot. Never touch the interior surfaces of the cooking compartment or the heating elements. Always allow the appliance to cool down. Keep children at a safe distance.
- Accessories and ovenware become very hot. Always use oven gloves to remove accessories or ovenware from the cooking compartment.
- Alcoholic vapours may catch fire in the hot cooking compartment. Never prepare food containing large quantities of drinks with a high alcohol content. Only use small quantities of drinks with a high alcohol content. Open the appliance door with care.

### **Risk of scalding!**

- The accessible parts become hot during operation. Never touch the hot parts. Keep children at a safe distance.
- When you open the appliance door, hot steam may escape. Open the appliance door with care. Keep children at a safe distance.
- Water in a hot cooking compartment may create hot steam. Never pour water into the hot cooking compartment.

### **Risk of injury!**

Scratched glass in the appliance door may develop into a crack. Do not use a glass scraper, sharp or abrasive cleaning aids or detergents.

## Risk of electric shock!

- Incorrect repairs are dangerous. Repairs may only be carried out by one of our trained after-sales engineers. If the appliance is faulty, unplug the mains plug or switch off the fuse in the fuse box. Contact the after-sales service.
- The cable insulation on electrical appliances may melt when touching hot parts of the appliance. Never bring electrical appliance cables into contact with hot parts of the appliance.
- Do not use any high-pressure cleaners or steam cleaners, which can result in an electric shock.
- When replacing the cooking compartment bulb, the bulb socket contacts are live. Before replacing the bulb, unplug the appliance from the mains or switch off the circuit breaker in the fuse box.
- A defective appliance may cause electric shock. Never switch on a defective appliance. Unplug the appliance from the mains or switch off the circuit breaker in the fuse box. Contact the after-sales service.

## Risk of burns!

The appliance will become very hot on the outside during the cleaning function. Never touch the appliance door. Allow the appliance to cool down. Keep children at a safe distance.

## Causes of damage

### Caution!

- Accessories, foil, greaseproof paper or ovenware on the cooking compartment floor: do not place accessories on the cooking compartment floor. Do not cover the cooking compartment floor with any sort of foil or greaseproof paper. Do not place ovenware on the cooking compartment floor if a temperature of over 50 °C has been set. This will cause heat to accumulate. The baking and roasting times will no longer be correct and the enamel will be damaged.
- Water in a hot cooking compartment: do not pour water into the cooking compartment when it is hot. This will cause steam. The temperature change can cause damage to the enamel.
- Moist food: do not store moist food in the cooking compartment when it is closed for prolonged periods This will damage the enamel.
- Fruit juice: when baking particularly juicy fruit pies, do not pack the baking tray too generously. Fruit juice dripping from the baking tray leaves stains that cannot be removed. If possible, use the deeper universal pan.
- Cooling with the appliance door open: only allow the cooking compartment to cool when it is closed. Even if the appliance door is only open a little, front panels of adjacent units could be damaged over time.
- Very dirty door seal: If the door seal is very dirty, the appliance door will no longer close properly when the appliance is in use. The fronts of adjacent units could be damaged. Always keep the door seal clean.
- Appliance door as a seat, shelf or worktop: Do not sit on the appliance door, or place or hang anything on it. Do not place any cookware or accessories on the appliance door.
- Inserting accessories: depending on the appliance model, accessories can scratch the door panel when closing the appliance door. Always insert the accessories into the cooking compartment as far as they will go.
- Carrying the appliance: do not carry or hold the appliance by the door handle. The door handle cannot support the weight of the appliance and could break.

# Your new oven

Here you will learn about your new oven. The control panel and the individual operating controls are explained. You will find information on the cooking compartment and the accessories.

## Control panel

Here is an overview of the control panel. The display never shows all of the symbols at the same time. Details may vary, depending on the appliance model.

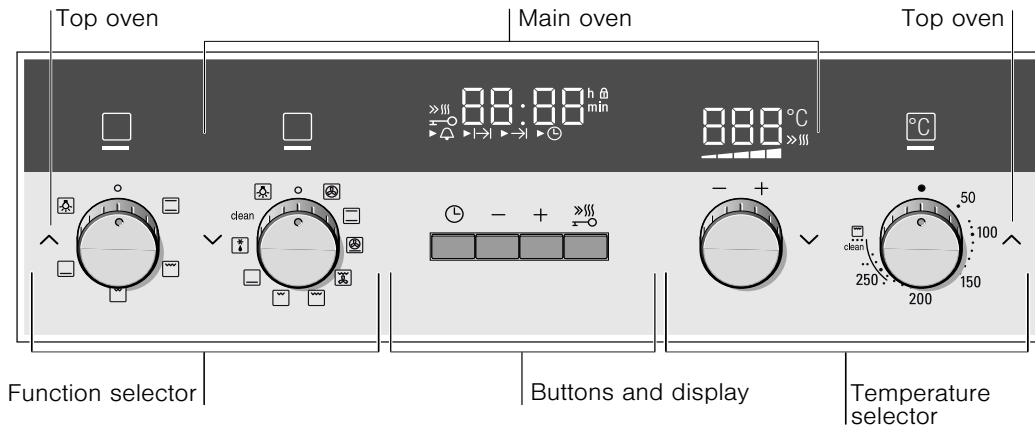

### Control knobs

The control knobs can be popped out. Simply press the control knob when it is in the off position to pop it in or out.

### Buttons and display

You can use the buttons to set various additional functions. On the display, you can read the values that you have set.

Button	Use
Time-setting options	Selects the timer  , cooking time  , end time  and clock  .
<b>-</b> Minus	Decreases the set values.
<b>+</b> Plus	Increases the set values.
Rapid heating	Heats up the oven particularly quickly.
Childproof lock	Locks and unlocks oven functions.

The time-setting option that is currently selected in the display is indicated by the arrow next to the corresponding symbol. Exception: For the clock, the symbol only lights up if the time is being changed.

### Function selector

Use the function selectors to set the type of heating.

#### Main oven

Setting	Use
Off position	The main oven is switched off.
3D hot air*	For cakes and pastries on one or more levels. The fan distributes the heat from the heating ring in the back panel evenly around the cooking compartment.

\* Type of heating used to determine the energy efficiency class according to EN50304.







Setting	Use
Top/bottom heating	For cakes, bakes and lean joints of meat, e.g. beef or game, on one level. The heat is emitted evenly from above and below.
Pizza setting	Quick preparation of frozen products without preheating, e.g. pizza, chips or strudel. The lower heating element and the heating ring in the back panel provide the heating.
Hot air grilling	Joints of meat, poultry and whole fish. The grill heating element and the fan switch on and off alternately. The fan causes the hot air to swirl around the dish.
Grill, large area	For grilling steaks, sausages, toast and pieces of fish. The whole area below the grill heating element becomes hot.
Grill, small area	For grilling small quantities of steaks, sausages, toast and pieces of fish. The centre part of the grill heating element becomes hot.
Bottom heating	For preserving and final baking or crisp browning. Heat is emitted from below.
Defrosting	For defrosting, e.g. meat, poultry, bread and cakes. The fan causes the warm air to swirl around the dish.

\* Type of heating used to determine the energy efficiency class according to EN50304.

Setting	Use
<b>clean</b> Cleaning system	For automatic cleaning of the specially coated parts in the cooking compartment.  The oven heats up until the dirt on the highly porous surface disintegrates.
 Oven light	Switches on the oven light.

\* Type of heating used to determine the energy efficiency class according to EN50304.

### Top oven

Setting	Use
 Off position	The top oven is switched off.
 Top/bottom heating	For cakes, bakes and lean joints of meat, e.g. beef or game, on one level.  The heat is emitted evenly from above and below.
 Grill, large area	For grilling steaks, sausages, toast and pieces of fish.  The whole area below the grill heating element becomes hot.
 Grill, small area	For grilling small quantities of steaks, sausages, toast and pieces of fish.  The centre part of the grill heating element becomes hot.
 Bottom heating	For preserving and final baking or crisp browning.  Heat is emitted from below.
 Oven light	Switches on the oven light.





When you make settings, the indicator lamp above the function selector lights up. The oven light in the cooking compartment switches on.

So that the heat is well distributed, the fan switches on briefly during the heating up phase when top or bottom heating is used.

## Temperature selector

### Main oven





Use the temperature selector to set the temperature, grill setting or cleaning level.

Setting	Meaning
30-300	Temperature range The temperature in the cooking compartment in °C.  Exception: Maximum temperature for  3D hot air and for  Pizza setting is 275 °C, and for  Defrosting it is 60 °C.
1, 2, 3	Grill settings The grill settings for the  Grill, small area and  Grill, large area.  Level 1 = low Level 2 = medium Level 3 = high
	Cleaning levels The cleaning levels for the <b>clean</b> Cleaning system.  Level 1 = gentle Level 2 = medium Level 3 = intensive

You can see which level is set in the display above the temperature selector.

### Top oven

Set the temperature or grill setting using the temperature selector.

Setting	Meaning
 Off position	The oven does not heat up.
50-270	Temperature range The temperature in the cooking compartment in °C.
 Grill settings	The grill settings for the  Grill, small area and  Grill, large area.  • = level 1, low •• = level 2, medium ••• = level 3, high
<b>clean</b>	Cleaning setting The setting for the cleaning system.

When the oven is heating, the indicator lamp above the temperature selector lights up. It goes out during heating pauses.

## Temperature indicator

The  main oven has a temperature indicator.

The five bars in the display above the temperature selector are used to indicate the temperature. They show the heating phases and the residual heat in the cooking compartment.

### Heating phases

After the appliance is started, the temperature indicator shows the heating phases. When all the bars are filled, the set temperature has been reached.

The bars do not appear when settings are made for grilling and cleaning.

### Residual heat

When the appliance is switched off, the temperature indicator shows the residual heat in the cooking compartment. If all the bars are filled, the temperature in the cooking compartment is approximately 300 °C. Once the temperature has dropped to approximately 60 °C, the display goes out.

For dishes with a long cooking time, you can switch the oven off 5-10 minutes before the end of the cooking time. The dish will continue to cook with the residual heat. This saves energy.

## Cooking compartment

The oven light is located in the cooking compartment. A cooling fan protects the oven from overheating.

### Oven light

During operation, the oven light in the cooking compartment is on. When temperatures up to 60 °C are selected, the light remains switched off. This enables precise temperature regulation.

The  setting on the function selector can be used to switch on the light without heating the oven.

### Cooling fan

The cooling fan switches on and off as required. The hot air escapes above the door. Caution: do not cover the ventilation slots. Otherwise the oven will overheat.

So that the cooking compartment cools down more quickly after operation, the cooling fan continues to run for a certain period afterwards.

# Your accessories

The accessories supplied with your appliance are suitable for making many meals. Ensure that you always insert the accessories into the cooking compartment the right way round.

There is also a selection of optional accessories, with which you can improve on some of your favourite dishes, or simply to make working with your oven more convenient.

## Inserting accessories

### Main oven

The accessories can be inserted into the oven at 3 different positions.

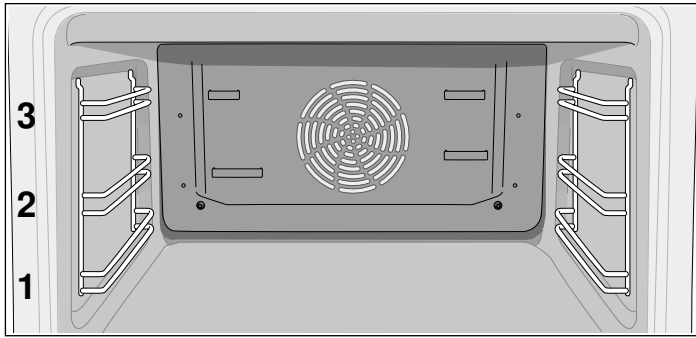

### Top oven

The accessories can be inserted into the oven at 2 different levels.

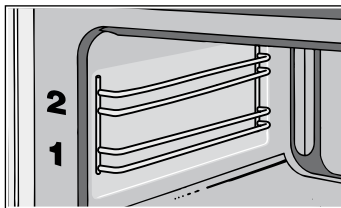

When sliding the accessories into the cooking compartment, ensure that the kink in the side rail is at the back. Only then will they lock in place.

The accessories can be pulled out approximately halfway until they lock in place. This allows meals to be removed easily.

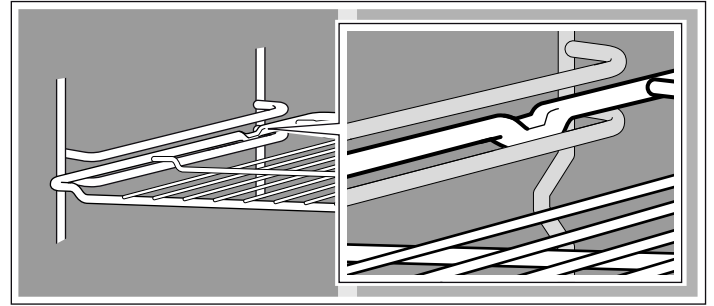

**Note:** The accessories may become deformed when they become hot. Once they cool down again, they regain their original shape. This does not affect their function.

You can buy accessories from the after-sales service, from specialist retailers or online. Please specify the HZ number.

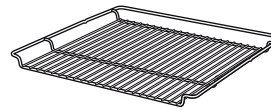

#### Wire rack

for baking in baking tins, roasting in roasting dishes and grilling



#### Universal pan, enamelled

for baking moist cakes, roasting, grilling and collecting drops of liquid during cooking

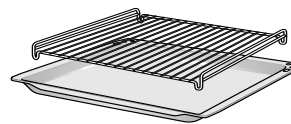

#### Insert grid

for roasting and grilling

**Note:** The wire insert is always used together with the universal pan. In this combination, the wire insert is placed in the universal pan.

## Optional accessories

You can purchase optional accessories from the after-sales service or specialist retailers. You will find a comprehensive range of products for your oven in our brochures and on the Internet. The availability of optional accessories and the option for ordering these online varies from country to country. Please see the sales brochures for more details.

Not all optional accessories are suitable for every appliance. When purchasing, please always quote the exact designation (E-no.) of your appliance.

Optional accessories	HZ number	Use
Wire rack	HZ334000	For ovenware, cake dishes, joints, grilled items and frozen meals.
Enamel baking tray	HZ331003	For cakes and biscuits. Push the baking tray into the oven with the sloping edge facing towards the oven door.
universal pan	HZ332003	For moist cakes, baked items, frozen meals and large joints. It can also be used to catch dripping fat when grilling directly on the wire rack. Slide the universal pan into the oven with the sloping edge facing the oven door.
Wire insert	HZ324000	For roasting. Always place the wire rack in the universal pan. This ensures that dripping fat and meat juices are collected.
Grill tray	HZ325000	Use for grilling in place of the wire rack or as a splatter guard, so that the oven does not become as dirty as it otherwise might. Only use the grill tray in the universal pan. Grilling on the grill tray: only use at shelf position 1, 2 and 3. Using the grill tray as a splatter guard: insert the universal pan with the grill tray under the wire rack.



<b>Optional accessories</b>	<b>HZ number</b>	<b>Use</b>
Pizza tray	HZ317000	Ideal for pizza, frozen products or large round cakes. You can use the pizza tray instead of the universal pan. Place the baking tray on the wire rack and proceed according to the details in the tables.
Bakestone	HZ327000	The bakestone is perfect for preparing home-made bread, bread rolls and pizzas which require a crispy base. The bakestone must always be preheated to the recommended temperature.
Enamel baking tray with non-stick coating	HZ331011	Cakes and biscuits can be removed more easily from the baking tray. Push the baking tray into the oven with the sloping edge facing towards the oven door.
Universal pan with non-stick coating	HZ332011	Moist cakes, baked items, frozen meals and large joints can be removed more easily from the universal pan. Slide the universal pan into the oven with the sloping edge facing the oven door.
Profi extra-deep pan with wire insert	HZ333003	Ideally suited for preparing large amounts.
Lid for the Profi extra-deep pan	HZ333001	The lid converts the Profi extra-deep pan into the Profi roasting dish.
Glass roasting dish	HZ915001	The glass roasting dish is suitable for stews and bakes that are cooked in the oven. It is ideally suited to automatic programmes or automatic roasting.
Telescopic shelves		
2-level	HZ338250	The pull-out rails fitted at positions 2 and 3 allow you to pull accessories out further without them tipping.
3-level	HZ338352	The pull-out rails fitted at positions 1, 2 and 3 allow you to pull accessories out further without them tipping. The 3-level pull-out is not suitable for appliances that have a rotary spit.
3-level complete pull-out	HZ338356	The pull-out rails fitted at positions 1, 2 and 3 allow you to pull accessories out fully without them tipping. The 3-level complete pull-out is not suitable for appliances that have a rotary spit.
3-level complete pull-out with stop function	HZ338357	The pull-out rails fitted at positions 1, 2 and 3 allow you to pull accessories out fully without them tipping. The pull-out rails lock in position allowing accessories to be easily placed on top. The 3-level complete pull-out with stop function is not suitable for appliances that have a rotary spit.
Self-cleaning side walls		
Appliance with an oven light	HZ339020	You can retrofit side walls so that the cooking compartment automatically cleans itself during operation.
Self-cleaning oven ceiling and side walls		
Appliances with one oven light and a folding grill element	HZ329020	You can retrofit the ceiling and side walls so that the cooking compartment automatically cleans itself during operation.
Appliances with two oven lights and a folding grill element	HZ329022	You can retrofit the ceiling and side walls so that the cooking compartment automatically cleans itself during operation.
Appliances with one oven light, a folding grill element and a meat thermometer	HZ329027	You can retrofit the ceiling and side walls so that the cooking compartment automatically cleans itself during operation.
Appliances with two oven lights, a folding grill element and a meat thermometer	HZ329028	You can retrofit the ceiling and side walls so that the cooking compartment automatically cleans itself during operation.
Steam filter	HZ329000	You can retrofit this to your oven. The steam filter filters out grease particles from the exhaust air, thereby reducing odours. Only for appliances with a 6, 7 or 8 as the second digit in the E-no. (e.g. HB38AB570)
System steamer	HZ24D300	For a gentler preparation of vegetables and fish.

## After-sales service products

You can obtain suitable care and cleaning agents and other accessories for your domestic appliances from the after-sales service, specialist retailers or (in some countries) online via the e-Shop. Please specify the relevant product number.

Cleaning cloths for stainless-steel surfaces	Product no. 311134	Reduces the build-up of dirt. Impregnated with a special oil for perfect maintenance of your appliance's stainless-steel surfaces.
Oven and grill cleaning gel	Product no. 463582	For cleaning the cooking compartment. The gel is odourless.
Microfibre cloth with honeycomb structure	Product no. 460770	Especially suitable for cleaning delicate surfaces, such as glass, glass ceramic, stainless steel or aluminium. The microfibre cloth removes liquid and grease deposits in one go.
Door lock	Product no. 612594	To prevent children from opening the oven door. The locks on different types of appliance door are screwed in differently. See the information sheet supplied with the door lock.

## Before using for the first time

Here, you will find out what you have to do before preparing food with your oven for the first time. Read the Safety information section beforehand.

### Setting the clock

After the appliance has been connected, the ⌚ symbol and three zeros flash in the display. Set the clock.

1. Press the ⌚ button.

The clock in the display shows 12:00. The time symbols light up and the ▶ arrow is next to ⌚.

2. Use the + or - button to set the clock.

After a few seconds, the time that has been set is adopted.

### Heating up the oven

To get rid of the new cooker smell, heat up the oven when it is empty and closed. Make sure that there are no packaging remains in the cooking compartments.

### Main oven √

1. Use the function selector to set 🍳 3D hot air.
2. Use the temperature selector to set the temperature to 240 °C.

### Top oven ^

1. Use the function selector to set 🍳 Top/bottom heating.
2. Use the temperature selector to set the temperature to 240 °C.

### Switching off

Turn the oven off after one hour. To do so, turn all function and temperature selectors to the off position.

### Cleaning accessories

Before using the accessories for the first time, clean them thoroughly using hot, soapy water and a soft cloth.

## Setting the oven

There are various ways in which you can set your oven. Here we will explain how you can select the desired type of heating and temperature or grill setting. You can select the oven cooking time and end time for your dish. Please refer to the section on *Setting the time-setting options*.

### Switching on the oven

Example shown below: Setting the Top/bottom heating to 190° C in the √ main oven.

1. Use the function selector to set the type of heating.

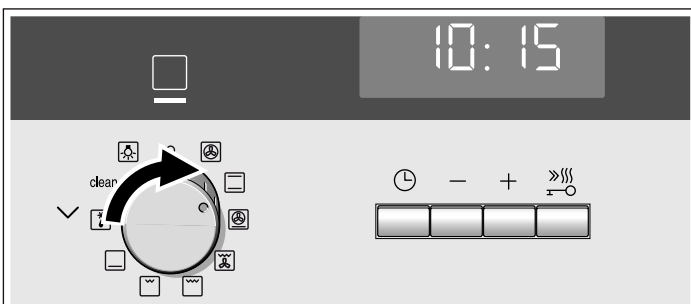

2. Set the temperature or grill setting using the temperature selector.

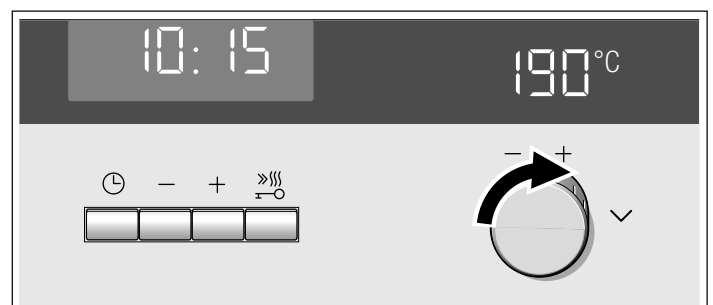

The main oven begins to heat up.

### Changing the settings

The type of heating and temperature or grill setting can be changed at any time with their respective selector.



### Switching off the oven

Turn the function and temperature selector to the off position.



## Rapid heating

You can switch on rapid heating for the √ main oven. The main oven will then reach the set temperature particularly quickly.

Use rapid heating when temperatures above 100 °C are selected. The following heating types are suitable:

- 3D hot air 
-  Top/bottom heating
- Pizza setting 



To ensure an even cooking result, do not place your dish in the cooking compartment until rapid heating is complete.

1. Set the heating type and temperature for the √ main oven.
2. Press the  button briefly.  
The  symbol lights up in the display. The oven begins to heat up.





### The rapid heating process is complete.

A signal sounds. The  symbol in the display goes out. Place your dish in the main oven.

### Cancelling rapid heating







Press the  button briefly. The  symbol in the display goes out.



## Setting the time-setting options

The √ main oven has various time-setting options. You can use the  button to access the menu and switch between the individual options. All the time symbols are lit during the time when you can make settings. The  arrow shows you the time-setting option that is active. A time-setting option that has already been set can be changed directly using the  or  buttons when the  arrow is next to the time symbol.

### Timer

You can use the timer as a kitchen timer. It runs independently of the oven. The timer has its own signal. In this way, you can tell whether it is the timer or a cooking time which has elapsed.



1. Press the  button once.  
The time symbols light up in the display and the  arrow is next to .
2. Use the  or  button to set the timer duration.  
Default value for  button = 10 minutes  
Default value for  button = 5 minutes

After a few seconds, the time setting is adopted. The timer starts. The   symbol lights up in the display and the timer duration counts down. The other time symbols go out.

### The timer duration has elapsed

A signal sounds. 0:00 is shown in the display. Use the  button to switch off the timer.

### Changing the timer duration







Use the  or  button to change the timer duration. After a few seconds, the change is adopted.

### Cancelling the timer duration

Use the  button to reset the timer duration to 0:00. The change will be adopted after a few seconds. The timer is switched off.

### Checking the time settings



If several time-setting options are set, the relevant symbols are illuminated on the display. The time-setting options symbol is in the foreground and preceded by the  arrow.

To call up the  timer,  cooking time,  end time or  clock, press the  button repeatedly until the  arrow is next to the relevant symbol. The display shows the value for a few seconds.





### Cooking time

You can set a cooking time for your dish in the √ main oven. When the cooking time has elapsed, the oven switches itself off automatically. This means that you do not have to interrupt other work to switch off the oven. The cooking time cannot be accidentally exceeded.

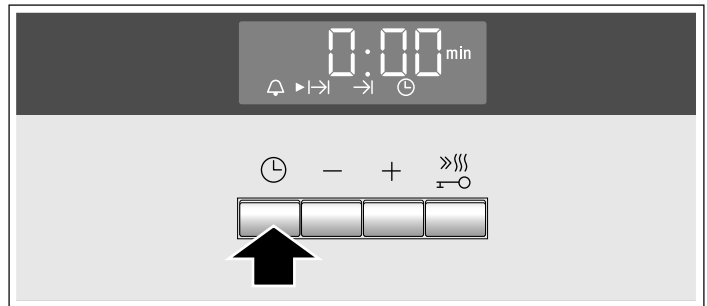

Example shown below: Cooking time of 45 minutes.

1. Use the function selector to adjust the type of heating for the √ main oven.
2. Use the temperature selector to set the temperature or grill setting for the √ main oven.
3. Press the  button twice. The display shows 0:00. The time symbols light up, the  arrow is in front of .



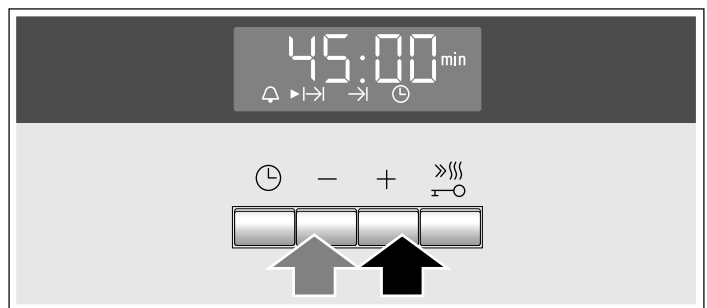



4. Use the  or  button to set the cooking time.
  - Default value for the  button = 30 minutes
  - Default value for the  button = 10 minutes





The oven will start up after a few seconds. The cooking time counts down in the display and the   symbol lights up. The other time symbols go out.

### The cooking time has elapsed

A signal sounds. The oven stops heating. 0:00 is shown in the display. Press the  button. You can set a new cooking time using the  or  button. Or press the  button twice and turn the function selector to the off position. The oven switches off.

### Changing the cooking time

Use the  or  button to change the cooking time. After a few seconds, the change is adopted. If the timer has been set, press the  button beforehand.

## Canceling the cooking time

Use the **-** button to reset the cooking time to 0:00. After a few seconds, the change is adopted. The cooking time is cancelled. If the timer has been set, press the **⏸** button beforehand.

## Checking the time settings

If several time-setting options are set, the relevant symbols are illuminated on the display. The time-setting options symbol is in the foreground and preceded by the **▶** arrow.

To call up the **⏰** timer, **I→I** cooking time, **→I** end time or **⌚** clock, press the **⏸** button repeatedly until the **▶** arrow is next to the relevant symbol. The display shows the value for a few seconds.

## End time

You can delay the time at which you wish your dish to be ready. The **✓** main oven starts automatically and finishes at the desired time. You can, for example, put your dish in the compartment in the morning and set the cooking time so that it is ready at lunch time.

Ensure that food is not left in the cooking compartment for too long as it may spoil.

Example shown below: It is 10:30, the cooking time is 45 minutes and you want to finish cooking at 12:30.

1. Set the function selector for the **✓** main oven.
2. Set the temperature selector for the **✓** main oven.
3. Press the **⏸** button twice.
4. Use the **+** or **-** button to set the cooking time.
5. Press the **⏸** button. The **▶** is in front of **→I**. The time when the dish will be ready is displayed.

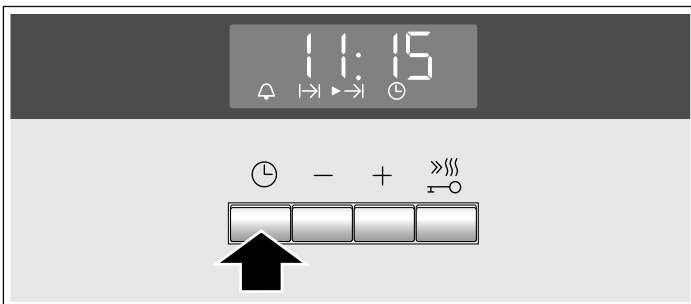

6. Use the button **+** or **-** to delay the end time.

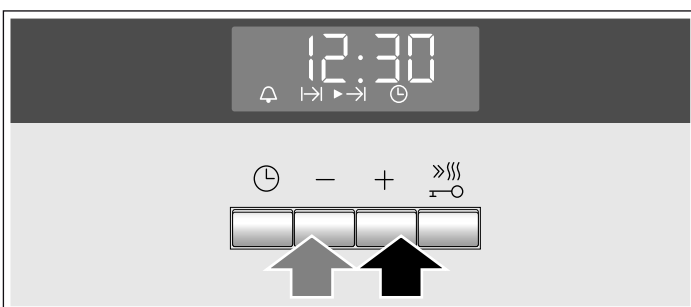

After a few seconds, the oven adopts the settings and switches to standby. The display shows the time at which the dish will be ready and the **▶** arrow is next to the **→I** symbol. The symbols **⏰** and **⌚** go out. When the oven starts, you will see the cooking time counting down in the display and the **▶** arrow will be next to the **I→I** symbol. The **→I** symbol goes out.

## The cooking time has elapsed

A signal sounds. The oven stops heating. 0:00 is shown in the display. Press the **⏸** button. You can set a new cooking time using the **+** or **-** button. Or press the **⏸** button twice and turn the function selector to the off position. The oven switches off.

## Changing the end time

Use the **+** or **-** button to change the end time. After a few seconds, the change is adopted. If the timer has been set, first press the **⏸** button twice. Do not change the end time if the cooking time has already started to elapse. The cooking result would no longer be correct.

## Canceling the end time

Use the **-** button to reset the end time to the current time. After a few seconds, the change is adopted. The oven starts. If the timer has been set, first press the **⏸** button twice.

## Checking the time settings

If several time-setting options are set, the relevant symbols are illuminated on the display. The time-setting options symbol is in the foreground and preceded by the **▶** arrow.

To call up the **⏰** timer, **I→I** cooking time, **→I** end time or **⌚** clock, press the **⏸** button repeatedly until the **▶** arrow is next to the relevant symbol. The display shows the value for a few seconds.

## Clock

After connecting the appliance to the mains or after a power cut, the **⌚** symbol and three zeros flash in the display. Set the clock.

1. Press the **⏸** button.  
The clock in the display shows 12:00. The time symbols light up and the **▶** arrow is next to **⌚**.
2. Use the **+** or **-** button to set the clock.  
After a few seconds, the time that has been set is adopted.

## Changing the clock

No other time-setting option should have been set.

1. Press the **⏸** button four times.  
The time symbols light up in the display and the **▶** arrow is next to **⌚**.
2. Use the **+** or **-** button to change the clock.  
After a few seconds, the time that has been set is adopted.

## Hiding the clock

You can hide the clock. For more information, please refer to the section *Changing the basic settings*.

## Childproof lock

The √ main oven has a childproof lock to prevent children from switching it on by accident or changing a setting.

The main oven does not respond to any settings. You can still set the clock and the timer when the childproof lock is activated.

### Switching on the childproof lock

The function selector must be set to the off position.

Press and hold the  button for approximately 4 seconds.

The  symbol appears in the display. The childproof lock is activated.

### Switching off the childproof lock

Press and hold the  button for approximately 4 seconds.

The  symbol in the display goes out. The childproof lock is deactivated.





## Changing the basic settings

The √ main oven has various basic settings. These settings can be customised to suit your requirements.

Basic setting	Selection 0	Selection 1	Selection 2	Selection 3
<b>c00</b> Brightness of the display lighting	-	night	medium*	day
<b>c01</b> Signal duration upon completion of a cooking time or timer period	-	approx. 10 seconds	approx. 2 minutes*	approx. 5 minutes
<b>c02</b> Clock display	only when in operation	always*	-	-
<b>c03</b> Waiting time until a setting is applied	-	approx. 2 seconds	approx. 5 seconds*	approx. 10 seconds
<b>c04</b> Self-cleaning ceiling and side walls retrofitted	no	yes*	-	-
<b>c05</b> Telescopic shelves retrofitted	no*	yes	-	-
<b>c06</b> Reset all values to the factory settings	no*	yes	-	-

\* Factory setting

The oven must be switched off.

1. Press and hold the  button for approx. 4 seconds.  
The current basic setting for signal duration is shown in the displays, e.g. c01 2 for selection 2.
2. Use the **+** or **-** button to change the basic setting.
3. Confirm by pressing the  button.  
The next basic setting is shown in the displays. You can scroll through all levels with the  button and change the setting with the **+** or **-** button.
4. To finish, press and hold the  button for approx. 4 seconds.

All basic settings are applied.

You may change the basic settings at any time.

## Automatic switch-off

The √ main oven has an automatic switch-off function.

If you do not change the settings on your appliance for several hours, the automatic switch-off function will be activated. The oven stops heating. When this occurs, it is based on the set temperature or grill setting.

### The automatic switch-off function is activated.

A signal sounds. F8 appears in the display. The oven stops heating.

Turn the function selector to the off position. The oven is switched off.

### Remove automatic switch-off

To prevent the automatic switch-off activating when not wanted, set a cooking time. The oven heats up until the cooking time has expired.

# Cleaning system

The cleaning system reheats the self-cleaning surfaces in the cooking compartment.

The back wall, ceiling and side walls of the cooking compartment are coated with a highly porous ceramic layer. This coating absorbs and dispels splashes from baking and roasting while the oven is in operation. If these self-cleaning surfaces in the oven no longer clean themselves adequately, they can be regenerated with the cleaning system.

## Cleaning levels for the main oven

You can select three cleaning levels for the main oven.

Level	Degree of cleaning	Cooking time
1	gentle	approx. 45 minutes
2	medium	approx. 1 hour
3	intensive	approx. 1 hour, 15 minutes

## Before cleaning

Remove accessories and cookware from the cooking compartment.

### Cleaning the cooking compartment floor

Before you set the cleaning system, clean the surfaces in the cooking compartment that are not self-cleaning. Otherwise, stains will develop that it is not possible to remove.





Use a dish cloth and hot soapy water or a vinegar solution. If there are heavy deposits of dirt, use a stainless steel scouring pad or oven cleaner. Only use when the cooking compartment is cold. Never treat the self-cleaning surfaces with a scouring pad or oven cleaner.

## Setting

### Main oven

When you have selected a cleaning level, make the setting on the oven.

1. Set the function selector to **clean** Cleaning system.
2. Use the temperature selector to set the cleaning level.

The display shows the time at which the cleaning will end and the  arrow is next to the  symbol. Cleaning will start after a few seconds. You can see the time counting down and the  arrow is next to the  symbol. The  symbol goes out.

## Cleaning is finished

A signal sounds. The oven stops heating. 0:00 is shown in the display. Turn the function selector to the off position. The oven switches off.

## Changing the cleaning level



Once the programme has started, you can no longer change the cleaning level.





## Cancelling cleaning

Turn the function selector to the off position. The oven switches off.

## Setting a later end time

You can delay the time at which the cleaning programme is due to finish. For instance, you can set the cleaning programme to run at night so that you can use your oven during the day.

Make the settings as described in steps 1 and 2. Before cleaning starts, use the  or  button to set a later end time.

The oven switches to standby. The display shows the time at which the cleaning will end and the  arrow is next to the  symbol. When cleaning starts, you will see the time counting down and the  arrow will be next to the  symbol. The  symbol goes out.

## Top oven

1. Set the function selector for the top oven to  Top/bottom heating.
2. Set the temperature selector to **clean**.
3. After approximately one hour, turn the function selector to the off position. The oven is switched off.

## After cleaning

When the cooking compartment has cooled down completely, wipe the salt residues off the self-cleaning surfaces with a damp cloth.

# Care and cleaning

With good care and cleaning, your oven will remain clean and fully-functioning for a long time to come. Here we will explain how to maintain and clean your oven correctly.

## Notes

- Slight differences in the colours on the front of the oven are caused by the use of different materials, such as glass, plastic and metal.
- Shadows on the door panel which look like streaks, are caused by reflections made by the oven light.
- Enamel is baked on at very high temperatures. This can cause some slight colour variations. This is normal and does not affect their function. The edges of thin trays cannot be completely enamelled. As a result, these edges can be rough. This will not impair the anti-corrosion protection.

## Cleaning agents

To ensure that the different surfaces are not damaged by using the wrong type of cleaning agent, observe the information in the table. Do not use

- harsh or abrasive cleaning agents,
- cleaning agents with a high concentration of alcohol,
- hard scouring pads or sponges,
- high-pressure cleaners or steam cleaners.

Wash new sponge cloths thoroughly before use.

Area	Cleaning agents
Control panel	Hot soapy water: Clean with a dish cloth and dry with a soft cloth. Do not use glass cleaners or glass scrapers.
Stainless steel	Hot soapy water: Clean with a dish cloth and dry with a soft cloth. Remove traces of limescale, grease, starch and albumin (e.g. egg white) immediately. Corrosion can form under such residues.  Special stainless steel cleaning products suitable for hot surfaces are available from our after-sales service or from specialist retailers. Apply a very thin layer of the cleaning product with a soft cloth.
Door panels	Glass cleaner: Clean with a soft cloth. Do not use a glass scraper.
Glass cover for the oven light	Hot soapy water: Clean with a dish cloth.
Seal Do not remove.	Hot soapy water: Clean with a dish cloth. Do not scour.
Rails	Hot soapy water: Soak and clean with a dish cloth or brush.
Telescopic shelves	Hot soapy water: Clean with a dish cloth or a brush.  Do not remove the lubricant while the pull-out rails are pulled out – it is best to clean them when they are inserted. Do not soak or clean in the dishwasher.
Accessories	Hot soapy water: Soak and clean with a dish cloth or brush.

### Cleaning the self-cleaning surfaces in the cooking compartment

The back wall, ceiling and side walls of the cooking compartment are coated with a highly porous ceramic layer. This coating absorbs and disintegrates splashes from baking and roasting while the oven is in operation. The higher the temperature and the longer the oven is in operation, the better the result will be.

Never treat the self-cleaning surfaces with oven cleaner.

If the self-cleaning surfaces no longer clean sufficiently, they can be regenerated with the cleaning system. For more information, please see the *Cleaning system* section.

Light discolouration of the coating does not affect automatic self-cleaning.

#### Caution!

- Never use abrasive cleaning agents. You will scratch or destroy the highly porous coating.
- Never treat the ceramic coating with oven cleaner. If oven cleaner accidentally gets onto it, remove it immediately with a sponge and plenty of water.

### Cleaning the cooking compartment floor

Use a dish cloth and hot soapy water or a vinegar solution.

If there are heavy deposits of dirt, use a stainless steel scouring pad or oven cleaner. Only use when the cooking compartment is cold. Never treat the self-cleaning surfaces with a scouring pad or oven cleaner.

## Cleaning the hook-in racks

You can remove the hook-in racks for easier cleaning.

**⚠ Risk of burning due to hot components in the cooking compartment!**

Wait until the cooking compartment has cooled down.

1. Push the hook-in rack upwards at the front and unhook to the side.
2. Pull the hook-in rack forwards at the rear and unhook to the side.

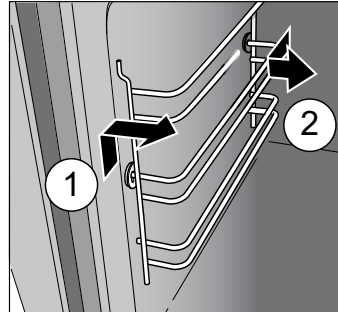

3. Clean the hook-in rack with washing-up liquid and a sponge or brush.
4. Align the hook-in rack with the kink (a) facing upwards, so that the shelf positions match.
5. Insert the hook-in rack at the rear as far as it will go.
6. Push the hook-in rack towards the rear.
7. Insert the hook-in rack at the front as far as it will go.
8. Push the hook-in rack downwards.

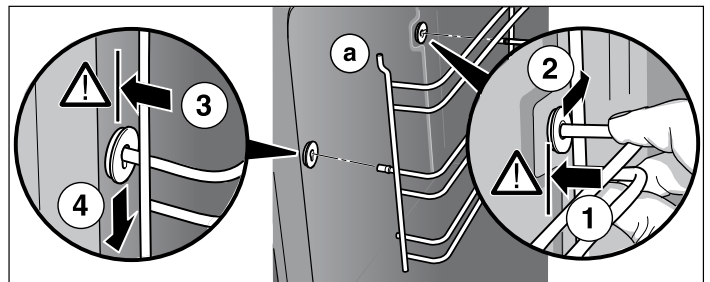

## Detaching and attaching the oven door

For cleaning purposes and to remove the door panels, you can detach the oven door.

The oven door hinges each have a locking lever. When the locking levers are closed (figure A), the oven door is secured in place. It cannot be detached. When the locking levers are open in order to detach the oven door (Fig. B), the hinges are locked. They cannot snap shut.

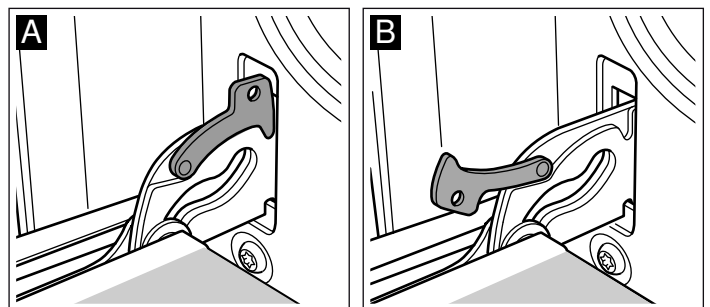

**⚠ Risk of injury!**

Whenever the hinges are not locked, they snap shut with great force. Ensure that the locking levers are always fully closed or, when detaching the oven door, fully open.

## Detaching the door

1. Open the oven door fully.
2. Fold up the two locking levers on the left and right (figure A).
3. Close the oven door as far as the limit stop. With both hands, grip the door on the left and right-hand sides. Close the door a little further and pull it out (figure B).

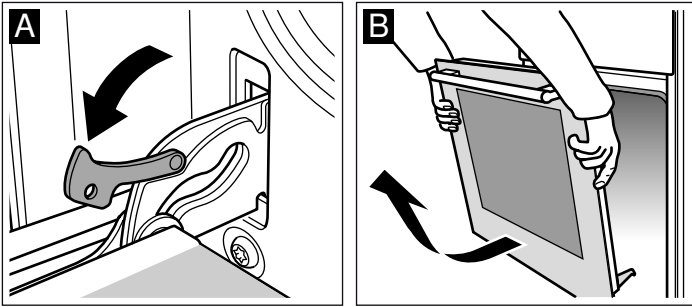

## Attaching the door

Reattach the oven door in the reverse sequence to removal.

1. When attaching the oven door, ensure that both hinges are inserted straight into the opening (figure A).
2. The notch on the hinge must engage on both sides (figure B).

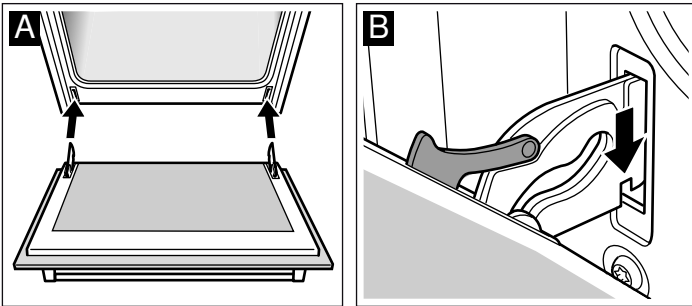

3. Fold back both locking levers (figure C). Close the oven door.

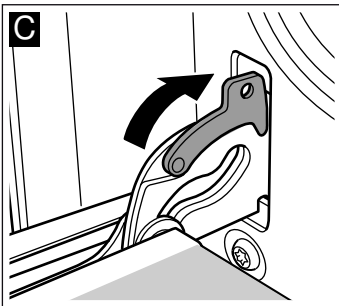

### **⚠ Risk of injury!**

If the oven door falls out accidentally or a hinge snaps shut, do not reach into the hinge. Call the after-sales service.

## Cleaning the door panels

To facilitate cleaning, you can remove the inner door panels from the appliance door.

### **⚠ Risk of injury!**

The components inside the appliance door may have sharp edges. Take care not to cut yourself. Wear protective gloves.

### **⚠ Risk of injury!**

The appliance must not be used again until the door panels and appliance door have been correctly fitted.

## Removing the door panel

**Note:** Before removing, make a note of which way round the door panel is fitted, so that it is not refitted the wrong way round.

1. Unhook the appliance door and lay it on a soft, clean surface with the front side facing downwards (see section: Removing and installing the appliance door).
2. Pull off the cover at the top of the appliance door. Press in the tabs on the left and right using your fingers (fig.A).
3. Lift the door panel slightly and pull it out (Fig. B).

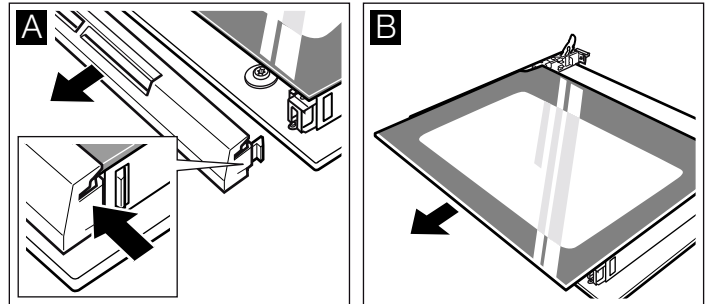

## Removing the intermediate panel

Lift the intermediate panel slightly and pull it out towards you.

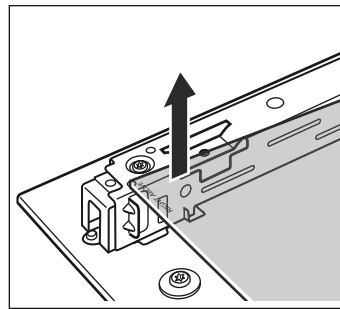

## Cleaning

Clean the door panel with glass cleaner and a soft cloth.

### **⚠ Risk of injury!**

Scratched glass in the appliance door may develop into a crack. Do not use a glass scraper, sharp or abrasive cleaning aids or detergents.

## Fitting the intermediate panel

**Note:** During installation, make sure that the lettering "top right" is upside down at the bottom left.

Insert the intermediate panel towards the back as far as it will go.

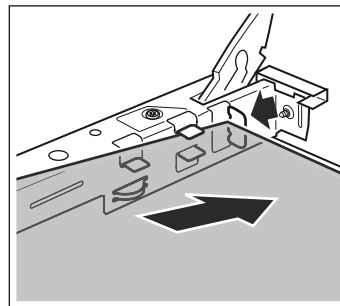



## Fitting the door panel

1. Insert the door panel at an angle towards the back into both brackets as far as it will go. The smooth surface must face outwards.

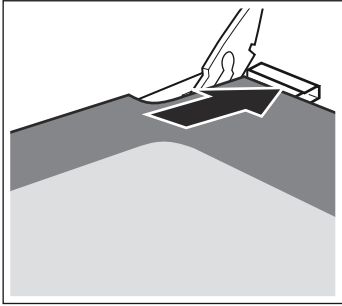

2. Put the cover back in place and press on it until it clicks in place.
3. Refit the appliance door.

## Troubleshooting

Malfunctions often have simple explanations. Refer to the table before calling the after-sales service as you may be able to remedy the fault yourself.

### Malfunction table

If a dish does not turn out as well as you had hoped, refer to the section *Tested for you in our cooking studio*, where you will find plenty of cooking tips and notes.

Problem	Possible cause	Remedy/information
The oven does not work.	The circuit breaker is defective.	Look in the fuse box and check that the circuit breaker is in working order.
	Power cut	Check whether the kitchen light or other kitchen appliances are working.
⊖ and zeros flash in the display.	Power cut	Reset the clock.
The oven does not heat up.	There is dust on the contacts.	Turn the control knobs back and forth several times.

### Error messages

If an error message with **E** appears, press the ⊖ button. The message disappears. A time function that has been set is cleared. If the error message does not disappear, please contact the after-sales service.

You can take remedial action yourself if the following error message is displayed.

Error message	Possible cause	Remedy/information
<b>E011</b>	A button was depressed for too long or is covered up.	Press all buttons individually. Check whether any buttons are jammed, covered up or soiled.

### Risk of electric shock!

Incorrect repairs are dangerous. Repairs may only be carried out by one of our trained after-sales engineers.

## Replacing the oven light bulb

Replace faulty oven light bulbs.

Spare bulbs can be obtained from the after-sales service or specialist retailers. Use the following oven lights for the top oven and the main oven: E14, 220 - 240 V, 25 W, heat-resistant to 300 °C

### Risk of electric shock !

Disconnect the appliance from the power supply. Switch off the circuit breaker or remove the fuse from the household fuse box.

1. Place a tea towel in the cold cooking compartment to prevent damage.
2. Turn the glass cover anticlockwise and remove it.

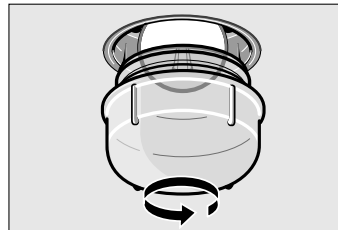

3. Replace the oven light bulb with a bulb of the same type.
4. Screw on the glass cover again.
5. Remove the tea towel and switch on the circuit breaker.

**Note:** Use rubber gloves if the glass cover cannot be unscrewed: Or order a special removal tool from the after-sales service:

- For the main oven: Order no. 613634
- For the top oven: Order no. 621743

## Glass cover

You must replace a damaged glass cover. Suitable glass covers may be obtained from the after-sales service. Please specify the E number and FD number of your appliance.

## After-sales service

Our after-sales service is there for you if your appliance needs to be repaired. We will always find the right solution in order to avoid unnecessary visits from a service technician.

### E number and FD number

When calling us, please give the product number (E no.) and the production number (FD no.) so that we can provide you with the correct advice. The rating plate containing these numbers can be found on the right-hand side of the oven door. You can make a note of the numbers of your appliance and the telephone number of the after-sales service in the space below to save time should it be required.

---

E no.	FD no.
-------	--------

---

After-sales service 

---

Please note that there will be a fee for a visit by a service technician in the event of a malfunction, even during the warranty period.

Please find the contact data of all countries in the enclosed customer service list.

### To book an engineer visit and product advice

**GB** 0344 892 8999

Calls charged at local or mobile rate.

**IE** 01450 2655

0.03 € per minute at peak. Off peak 0.0088 € per minute.

Rely on the professionalism of the manufacturer. You can therefore be sure that the repair is carried out by trained service technicians who carry original spare parts for your appliances.

## Energy and environment tips

Here you can find tips on how to save energy when baking and roasting and how to dispose of your appliance properly.

### Saving energy

- Only preheat the oven if this is specified in the recipe or in the operating instruction tables.
- Use dark, black lacquered or enamelled baking tins. They absorb the heat particularly well.
- Open the oven door as infrequently as possible while you are cooking, baking or roasting.
- It is best to bake several cakes one after the other. The oven is still warm. This reduces the baking time for the second cake. You can also place two loaf tins next to each other.
- For longer cooking times, you can switch the oven off 10 minutes before the end of the cooking time and use the residual heat to finish cooking.

### Environmentally-friendly disposal

Dispose of packaging in an environmentally-friendly manner.



This appliance is labelled in accordance with European Directive 2012/19/EU concerning used electrical and electronic appliances (waste electrical and electronic equipment - WEEE). The guideline determines the framework for the return and recycling of used appliances as applicable throughout the EU.

## Tested for you in our cooking studio



Here you will find a selection of dishes and the ideal settings for them. We will show you which type of heating and which temperature are best suited for your dish. You can find information about suitable accessories and the height at which they should be inserted. There are also tips about cookware and preparation methods.

### Notes

- The values in the table always apply to dishes placed into the cooking compartment when it is cold and empty.  
Only preheat the appliance if the table specifies that you should do so. Do not line the accessories with greaseproof paper until after they have been preheated.
- The times specified in the tables are guidelines only. They will depend on the quality and composition of the food.
- Use the accessories supplied. Additional accessories may be obtained as special accessories from specialist retailers or from the after-sales service.  
Before using the oven, remove any unnecessary accessories and ovenware from the cooking compartment.
- Always use oven gloves when taking hot accessories or ovenware out of the cooking compartment.

### Cakes and pastries

#### Baking on one level

When baking cakes, the best results can be achieved using  Top/bottom heating. When baking with  3D hot air, note the following: Bake cakes in tins and on a tray at shelf height 1.

#### Baking on two or more levels

Use  3D hot air.

Baking on 2 levels:

- Baking tray in shelf position 3
- Universal pan in shelf position 1

Baking trays that are placed in the oven at the same time will not necessarily be ready at the same time.

The tables show numerous suggestions for well-known dishes.

2 small, round cake tins on one level should be placed diagonally on the wire rack.

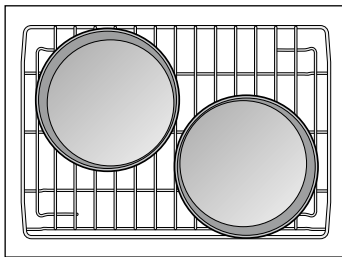

For 4 small, round cake tins, place 2 diagonally on each wire rack. Slide in the wire racks one on top another, one on each level.

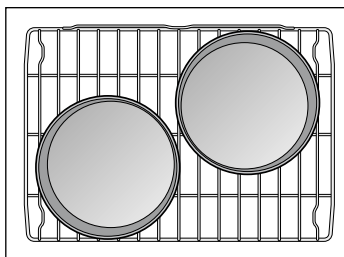
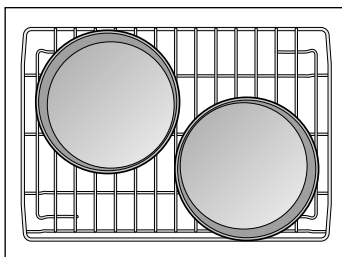

## Baking tins

It is best to use dark-coloured metal baking tins. Baking times are increased when light-coloured baking tins made of thin metal or glass dishes are used, and cakes do not brown so evenly.

If you wish to use silicone baking tins, use the information and recipes provided by the manufacturer as a guide. Silicone baking tins are often smaller than normal tins. The amount of mixture and recipe instructions may differ.

## Tables

The tables show the ideal type of heating for the various cakes and pastries. The temperature and baking time depend on the amount and consistency of the mixture. This is why temperature ranges are given in the tables. You should try the lower temperature first, since a lower temperature allows more even browning. You can increase the temperature next time if necessary.

More information can be found in the "Baking tips" section which follows the tables.

### √ Main oven

Food	Dish	Shelf position	Type of heating	Temperature in °C	Baking time in minutes
Victoria sandwich	Wire rack + 2 tins, dia. 20 cm	1	☐*	160-170	25-30
			☉*	160-170	25-30
Light fruit cake	Wire rack + deep tin, dia. 20 cm	1	☐*	140-150	80-100
			☉*	140-150	80-100
Rich fruit cake	Wire rack + deep round tin, dia. 23 cm or square tin, 20 cm	1	☉*	140-150	210-240
Fruit crumble	Wire rack + flat glass dish	2	☐*	180-190	40-50
		1	☉*	160-170	40-50
Sponge cake (fat-free)	Wire rack + baking tin (dark coated)	1	☐*	160-170	25-35
			☉*	160-170	25-35
Swiss roll	Wire rack + Swiss roll tin	1	☉*	170-180	10-15
Tart	Universal pan + plate or pie tin, dia. 20 cm	2	☐*	180-190	50-60
	Wire rack + plate or pie tin, dia. 20 cm	1	☉*	180-190	50-60
Quiche	Wire rack + quiche tin (dark coated)	1	☐*	190-210	45-55
			☉*	170-180	45-55
(White) bread	Wire rack + loaf tin (1 x 900 g or 2 x 450 g)	1	☐*	220-230	20-30
			☉*	210-220	20-30
Scones	Universal pan	2	☐*	210-220	9-12
		1	☉*	180-200	8-10
Biscuits	Universal pan	2	☐*	170-180	15-20
		1	☉*	160-170	15-20
Small cakes	Wire rack + 12-cup tin	1	☐*	160-170	20-25
			☉*	160-170	25-35
Jam tarts	Wire rack + 12-cup tin	2	☐*	200-210	15-20
		1	☉*	180-190	15-20
Meringues	Universal pan	1	☉*	80-90	100-150
Pavlova	Universal pan	1	☉**	150*** + 100	100-150
Pie	Wire rack + pie dish	1	☉*	180-190	45-50

\* preheat

\*\* preheat at higher temperature, then reduce and insert food

Food	Dish	Shelf position	Type of heating	Temperature in °C	Baking time in minutes
Yorkshire pudding	Universal pan + 12-cup tin	2	☐*	230-240	10-15
		1	☉*	200-220	10-15
Jacket potatoes	Universal pan	1	☉*	170-180	60-70
Pizza (homemade)	Universal pan	2	☐*	220-230	20-30
		1	☉*	210-220	20-30

\* preheat

\*\* preheat at higher temperature, then reduce and insert food

Food	Dish	Shelf position	Type of heating	Temperature in °C	Baking time in minutes
Victoria sandwich 2 levels	2 wire racks + 4 tins, dia. 20 cm	3+1	☉*	160-170	25-30
Scones 2 levels	Wire rack with baking tray + universal pan	3+1	☉*	180-200	8-12
Biscuits 2 levels	Wire rack with baking tray + universal pan	3+1	☉*	160-170	15-20
Small cakes 2 levels	2 wire racks + 2 12-cup tins	3+1	☉*	150-160	20-30
Jacket potatoes, 2 levels	2 wire racks	3+1	☉*	160-170	65-75
Pizza (homemade)	Wire rack with baking tray + universal pan	3+1	☉*	180-190	35-45

\* preheat



## ^ Top oven

Food	Dish	Shelf position	Type of heating	Temperature in °C	Time in minutes
Victoria sandwich	Wire rack + 1 tin, dia. 20 cm	1	☐*	160-170	25-30
Scones	Wire rack + baking tray	1	☐*	200-210	10-12
Small cakes	Wire rack + 12-cup tin	1	☐*	150-160	25-30
Jam tarts	Wire rack + 12-cup tin	1	☐*	190-210	15-25
Swiss roll	Wire rack + Swiss roll tin	1	☐*	180-190	10-15
Biscuits	Wire rack + baking tray	1	☐*	170-180	10-15
Meringues	Wire rack + baking tray	1	☐*	80	110-140

\* Preheat.

## Baking tips

You wish to bake according to your own recipe.	Use similar items in the baking tables as a guide.
How to establish whether sponge cake is baked through.	Approximately 10 minutes before the end of the baking time specified in the recipe, stick a cocktail stick into the cake at the highest point. If the cocktail stick comes out clean, the cake is ready.
The cake collapses.	Use less fluid next time or set the oven temperature 10 degrees lower. Observe the specified mixing times in the recipe.
The cake has risen in the middle but is lower around the edge.	Do not grease the sides of the springform cake tin. After baking, loosen the cake carefully with a knife.
The cake goes too dark on top.	Place it lower in the oven, select a lower temperature and bake the cake for a little longer.
The cake is too dry.	When it is done, make small holes in the cake using a cocktail stick. Then drizzle fruit juice or an alcoholic beverage over it. Next time, select a temperature 10 degrees higher and reduce the baking time.
The bread or cake (e.g. cheesecake) looks good, but is soggy on the inside (sticky, streaked with water).	Use slightly less fluid next time and bake for slightly longer at a lower temperature. For cakes with a moist topping, bake the base first. Sprinkle it with almonds or bread crumbs and then place the topping on top. Please follow the recipe and baking times.

The cake is unevenly browned.	Select a slightly lower temperature to ensure that the cake is baked more evenly. Bake delicate pastries on one level using  Top/bottom heating. Protruding greaseproof paper can affect the air circulation. For this reason, always cut greaseproof paper to fit the baking tray.
The bottom of a fruit cake is too light.	Place the cake one level lower the next time.
The fruit juice overflows.	Next time, use the deeper universal pan, if you have one.
Small baked items made out of yeast dough stick to one another when baking.	There should be a gap of approx. 2 cm around each item. This gives enough space for the baked items to expand well and turn brown on all sides.
You were baking on several levels. The items on the top baking tray are darker than that on the bottom baking tray.	Always use  3D hot air to bake on more than one level. Baking trays that are placed in the oven at the same time will not necessarily be ready at the same time.
Condensation forms when you bake moist cakes.	Baking may result in the formation of water vapour, which escapes above the door. The steam may settle and form water droplets on the control panel or on the fronts of adjacent units. This is a natural process.

## Meat, poultry, fish

### Ovenware

The universal pan with insert wire rack is suitable for large roasts. You may also use any heat-resistant ovenware.

Glass ovenware is the most suitable. Ensure that the lid of the roasting dish fits well and closes properly.

Add a little more liquid when using enamelled roasting dishes.

With roasting dishes made of stainless steel, browning is not so intense and the meat may be somewhat less well cooked. Increase the cooking times.

Always place the ovenware in the centre of the wire rack.

Place hot glass ovenware on a dry mat after cooking. The glass could crack if placed on a cold or wet surface.

### Roasting



The information in the table applies to food placed in a cold oven and for meat taken directly from the refrigerator.

The joints of meat should weigh between 500 g and 2 kg.

Ensure that you always use the lower temperature, if the weight of the joint you wish to roast is high.

If there are several pieces of meat, calculate the roasting time using the weight of the heaviest piece of meat. The individual pieces of meat should be approximately the same size.















### Meat



When using the  Top/bottom heating and  Circulated air grilling types of heating, turn the pieces of meat halfway through the cooking time.





When the roast is ready, turn off the oven and allow it to rest for 10 minutes. This allows better distribution of the meat juices.

When roasting joints of pork with a rind, make cuts in the rind crossways and if it is to be turned, first place the joint with the rind side down in the dish.

### √ Main oven

Meat	Dish	Shelf position	Type of heating	Temperature in °C	Time, mins per 500 g + add. time
<b>Beef</b>					
Slow roast joint	Universal pan with roasting rack	1		130-140	40+40
Top side and top rump	Universal pan with roasting rack	1		160-170	30+25
<b>Lamb</b>					
Leg	Universal pan with roasting rack	1		160-170	30+25
Shoulder (on the bone)	Universal pan with roasting rack	1		160-170	25+20
Shoulder (boned and rolled)	Universal pan with roasting rack	1		170-180	25+25
Rack of lamb	Universal pan with roasting rack	1		180-190	25+25
<b>Pork</b>					
Roast joint	Universal pan with roasting rack	1		180-190	35+35
Loin joint	Universal pan with roasting rack	1		170-180	30+30
Belly	Universal pan with roasting rack	1		160-170	30+25
Gammon joint	Universal pan with roasting rack	1		160-170	30+30
<b>Poultry</b>					
Chicken	Universal pan with roasting rack	1		170-180	20+25
Chicken, portion	Universal pan with roasting rack	1		190-200	20+25
Chicken, quarter (450 g each)	Universal pan with roasting rack	1		180-190	20+25
Duck	Universal pan with roasting rack	1		180-190	20+20
Turkey, crown	Universal pan with roasting rack	1		160-170	15+15

Meat	Dish	Shelf position	Type of heating	Temperature in °C	Time, mins per 500 g + add. time
<b>Casserole</b>					
Diced meat (beef, pork, lamb)	Wire rack + glass roasting dish with lid	2		140	120-150 total time
Braising steaks	Wire rack + glass roasting dish with lid	2		140	120-150 total time
Chicken	Wire rack + glass roasting dish with lid	2		140	60-90

Meat	Dish	Shelf position	Type of heating	Temperature in °C	Time, mins per 500 g + add. time
<b>Beef</b>					
Top side and top rump	Universal pan with roasting rack	2		200-220	25+25
<b>Lamb</b>					
Leg	Universal pan with roasting rack	1		170-190	30+35
<b>Pork</b>					
Roast joint	Universal pan with roasting rack	1		180-200	35+40
<b>Poultry</b>					
Chicken	Universal pan with roasting rack	1		200-220	20+15
Chicken, quarter (450 g each)	Universal pan with roasting rack	2		210-230	20+25

### Tips for grilling

Always grill with the oven door closed.

When grilling, preheat the oven for approx. 3 minutes, before putting the food in.

Place the food to be grilled directly on the wire rack. If you are grilling a single piece of food, the best results are achieved by placing it in the centre of the wire rack. The universal pan should also be inserted underneath. The meat juices are collected in the pan and the oven is kept cleaner.

Do not insert the baking tray or universal pan at level 3. The high heat distorts it and the cooking compartment can be damaged when removing it.









If possible, grill items should be of equal thickness. This ensures that they brown evenly while also remaining succulent. Only add salt to steaks once they have been grilled.

Turn grilled items after the specified time.

Whole fish does not need to be turned. Place the whole fish in the oven in its swimming position with its dorsal fin facing upwards. Placing a scored potato or a small oven-proof container in the stomach cavity of the fish will provide stability.

The grill element switches on and off intermittently. This is normal. How often this happens depends on the selected grill setting.

### ✓ Main oven

Meat	Dish	Shelf position	Type of heating	Grill setting	Time, minutes
<b>Beef</b>					
Steaks, 2-3 cm thick	Wire rack + universal pan	3+ 1		3	1st side 10-13, 2nd side 6-8
Burgers, 1-2 cm thick	Wire rack + universal pan	3+ 1		3	1st side 10-12, 2nd side 6-8
<b>Lamb</b>					
Steaks, 2-3 cm thick	Wire rack + universal pan	3+ 1		3	1st side 6-8, 2nd side 4-6
Chops, 2-3 cm thick	Wire rack + universal pan	3+ 1		3	1st side 7-9, 2nd side 5-8
<b>Pork</b>					
Steaks, 1-2 cm thick	Wire rack + universal pan	3+ 1		3	1st side 9-12, 2nd side 6-8
Chops, 2-3 cm thick	Wire rack + universal pan	3+ 1		3	1st side 10-13, 2nd side 8-12
Burgers, 1-2 cm thick	Wire rack + universal pan	3+ 1		3	1st side 10-12, 2nd side 6-8
Sausages, 2-4 cm thick	Wire rack + universal pan	3+ 1		3	14-18, turn occasionally

Meat	Dish	Shelf position	Type of heating	Grill setting	Time, minutes
<b>Gammon</b>					
Steaks, 1-3 cm thick	Wire rack + universal pan	3+ 1		3	1st side 10-12, 2nd side 5-7
<b>Chicken</b>					
Drumsticks, 150 g each	Wire rack + universal pan	3+ 1		3	1st side 16-20, 2nd side 12-15
Breast, boneless, 150 g each	Wire rack + universal pan	3+ 1		3	1st side 13-15, 2nd side 8-10
<b>Fish</b>					
Whole trout, 300 g each	Wire rack + universal pan	2+ 1		2	25-30
Fillets, 150 g each	Wire rack + universal pan	3+ 1		3	15-20

### ^ Top oven

Observe the notes in the table about preheating.

Food	Dish	Shelf position	Type of heating	Grill setting	Time in minutes
<b>Beef</b>					
Steaks 2-3 cm thick	Wire rack + universal pan	2+ 1	*	3	1st side 10-13, 2nd side 6-8
Burgers 1-2 cm thick	Wire rack + universal pan	2+ 1		3	1st side 10-12, 2nd side 6-8
<b>Lamb</b>					
Steaks 2-3 cm thick	Wire rack + universal pan	2+ 1	*	3	1st side 6-8, 2nd side 4-6
Chops 2-3 cm thick	Wire rack + universal pan	2+ 1	*	3	1st side 7-9, 2nd side 5-8
<b>Pork</b>					
Steaks 1-2 cm thick	Wire rack + universal pan	2+ 1	*	3	1st side 9-12, 2nd side 6-8
Chops 2-3 cm thick	Wire rack + universal pan	2+ 1	*	3	1st side 10-13, 2nd side 8-12
Burgers 1-2 cm thick	Wire rack + universal pan	2+ 1		3	1st side 10-12, 2nd side 6-8
Sausages 2-4 cm thick	Wire rack + universal pan	2+ 1		3	14 - -18**
<b>Chicken</b>					
Drumsticks 150 g each	Wire rack + universal pan	2+ 1		2	1st side 16-20, 2nd side 12-15
Breast (boneless) 150 g each	Wire rack + universal pan	2+ 1		2	1st side 13-15, 2nd side 8-10
<b>Fish</b>					
Whole trout 300 g each	Wire rack + universal pan	2+ 1		1	25-30
Fillets 150 g each	Wire rack + universal pan	2+ 1		1	15-20

\* Preheat for 3 minutes

\*\* Turn frequently

## Tips for roasting and grilling

The table does not contain information for the weight of the joint.	Select the next lowest weight from the instructions and extend the time.
How to tell when the roast is ready.	Use a meat thermometer (available from specialist shops) or carry out a "spoon test". Press down on the roast with a spoon. If it feels firm, it is ready. If the spoon can be pressed in, it needs to be cooked for a little longer.
The roast is too dark and the crackling is partly burnt.	Check the shelf height and temperature.
The roast looks good but the juices are burnt.	Next time, use a smaller roasting dish or add more liquid.
The roast looks good but the juices are too clear and watery.	Next time, use a larger roasting dish and use less liquid.
Steam rises from the roast when basted.	This is normal and due to the laws of physics. The majority of the steam escapes through the steam outlet. It may settle and form condensation on the cooler switch panel or on the fronts of adjacent units.

## Preprepared products

Observe the instructions on the packaging.





















If you line the accessories with greaseproof paper, make sure that the paper is suitable for these temperatures. Make sure the paper is a suitable size for the dish to be cooked.

The cooking result greatly depends on the quality of the food. Pre-browning and unevenness can sometimes even be found on the raw product.

Leave a little space between bread rolls when crisping them up. Do not place too many bread rolls on the accessories.

Sprinkle grated cheese over the top of your lasagne to give it a beautiful and evenly browned finish.

### √ Main oven

Food	Dish	Shelf position	Type of heating	Temperature in °C	Time in minutes
<b>Pizza, frozen</b>					
Pizza with a thin base	Universal pan	1	 *	180-200	10-20
			 *	200-210	15-25
Pizza with a thick base	Universal pan	1	 *	180-200	10-20
			 *	200-210	15-25
Pizza baguette	Universal pan	1	 *	170-190	20-30
			 *	170-180	25-30
<b>Pizza, chilled</b>					
Pizza, chilled	Universal pan	1	 *	190-200	10-15
			 *	200-210	10-15
<b>Potato products, frozen</b>					
Chips	Universal pan	1	 *	180-190	20-25
			 *	180-220	25-30
Duchess potatoes	Universal pan	1	 *	190-210	20-25
			 *	200-210	15-20
Hash browns (fried potatoes), filled potato skins	Universal pan	1	 *	200-220	15-25
			 *	200-210	15-20
Potato wedges	Universal pan	1	 *	180-190	15-20
			 *	180-190	20-25
<b>Baked goods, frozen</b>					
Rolls, baguettes	Universal pan	1	 *	180-190	5-15
			 *	180-190	10-20
<b>Baked goods, prebaked</b>					
Part-baked white bread	Universal pan	1	 *	190-200	10-20
			 *	180-190	10-20

\* preheat



Food	Dish	Shelf position	Type of heating	Temperature in °C	Time in minutes
<b>Fried foods, frozen</b>					
Fish fingers	Universal pan	1	*	180-200	10-20
			*	180-200	15-20
<b>Food, frozen</b>					
Lasagne, 400 g	Wire rack	1	*	170-180	35-40
			*	180-190	35-40
Lasagne, 1200 g	Wire rack	1	*	170-180	40-50
			*	180-190	40-50
<b>Food, chilled</b>					
Lasagne, 400 g	Wire rack	2	*	170-180	35-50
Lasagne, 1200 g	Wire rack	2	*	170-180	40-45

\* preheat

## Special dishes

At low temperatures, 3D hot air is equally useful for producing creamy yoghurt as it is for proving light yeast dough.

First, remove accessories, hook-in racks or telescopic shelves from the cooking compartment.

### Preparing yoghurt

1. Bring 1 litre of milk (3.5 % fat) to the boil and cool down to 40 °C.
2. Stir in 150 g of yoghurt (chilled).
3. Pour into cups or small screw-top jars and cover with cling film.
4. Preheat the cooking compartment as indicated.
5. Place the cups or jars on the cooking compartment floor and incubate as indicated.

### Proving dough

1. Prepare the dough as usual, place it in a heat-resistant ceramic dish and cover.
2. Preheat the cooking compartment as indicated.
3. Switch off the oven and place the dough in the cooking compartment and leave it to prove.

## Main oven

Meal	Cookware	Level	Type of heating	Temperature	Cooking time
Yoghurt	Cups or screw-top jars	Place on the cooking compartment floor		Preheat to 50 °C	5 mins
				Switch on the  oven light	approx. 8 hrs
Proving dough	Heat-resistant dish	Place on the cooking compartment floor		Preheat to 50 °C	10 mins
				Switch off the appliance, place the yeast dough in the cooking compartment	20-30 mins

## Upper oven

Meal	Cookware	Level	Type of heating	Temperature	Cooking time
Yoghurt	Cups or screw-top jars	Place on the cooking compartment floor		Preheat to 100 °C	15 mins
				Switch on the  oven light	approx. 8 hrs

## Defrost

This  Defrost setting is most ideal for frozen goods.



The defrosting time will depend on the type and quantity of the food.

Observe the instructions on the packaging.

Take frozen food out of its packaging and place in suitable ovenware on the wire rack.

Place poultry on a plate with the breast side facing down.

**Note:** The oven light does not come on at temperatures of less than 60 °C. This enables precise temperature regulation.

Dish	Accessories	Level	Type of heating	Temperature
<b>Delicate frozen foods</b> e.g. cream gateaux, buttercream cakes, gateaux with chocolate or sugar-based icing, fruit, etc.	wire rack	1		30 °C
<b>Other frozen products</b> Chicken, sausage and meat, bread and bread rolls, cake and other baked goods	wire rack	1		50 °C





## Desiccation

Use unblemished fruit and vegetables only and wash it thoroughly.

Drain off the excess water, then wipe it dry.

Insert the universal pan at shelf height 1, insert wire rack at shelf height 3. Line the universal pan and the wire rack with greaseproof or parchment paper.

Turn very juicy fruit or vegetables several times. Remove fruit and vegetables from the paper as soon as they have dried.

Dishes	Level	Type of heating	Temperature in °C	Cooking time in hours
600 g apple rings	1+3		80	approx. 5
800 g pear slices	1+3		80	approx. 8
1.5 kg damsons or plums	1+3		80	approx. 8-10
200 g herbs, washed	1+3		80	approx. 1½

## Acrylamide in foodstuffs

Acrylamide is mainly produced in grain and potato products prepared at high temperatures, such as potato crisps, chips, toast, bread rolls, bread or fine baked goods (biscuits, gingerbread, cookies).

### Tips for keeping acrylamide to a minimum when preparing food

<b>General</b>	<ul style="list-style-type: none"> <li>■ Keep cooking times to a minimum.</li> <li>■ Cook meals until they are golden brown, but not too dark.</li> <li>■ Large, thick pieces of food contain less acrylamide.</li> </ul>
<b>Baking</b>	<p>With top/bottom heating max. 200 °C. With 3D hot air or hot air max. 180 °C.</p>
Biscuits	<p>With top/bottom heating max. 190 °C. With 3D hot air or hot air max. 170 °C. Egg or egg yolk reduces the production of acrylamide.</p>
Oven chips	<p>Spread evenly over the baking tray, in a single layer. Bake at least 400 g per baking tray so that the chips do not dry out</p>

# Test dishes

These tables have been produced for test institutes to facilitate the inspection and testing of the various appliances.

In accordance with EN 50304/EN 60350 (2009) and IEC 60350.

## Baking

When baking on two levels, always insert the baking tray above the universal pan.

Piped cookies: Food on baking trays that are placed in the oven at the same time will not necessarily all be ready at the same time.

German apple pie on 1 level:  
place dark springform cake tins next to each other diagonally.

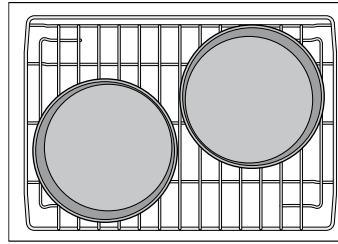

**Note:** For baking, use the lower of the temperatures indicated first.

✓ Main oven

Meal	Accessories and cookware	Level	Type of heating	Temperature in °C	Cooking time in minutes
Piped cookies*	baking tray	2		150-160	15-30
	baking tray	1		140-150	20-30
	Baking tray + universal pan	3+1		140-150	20-30
Small cakes**	baking tray	2		160-170	20-30
	baking tray	1		150-160	25-35
	Baking tray + universal pan	3+1		150-160	25-35
Hot water sponge cake*	Springform cake tin on the wire rack	1		160-170	25-35
	Springform cake tin on the wire rack	1		160-170	25-35
German apple pie*	Wire rack + 2 springform cake tins, dia. 20 cm	1		170-180	70-80

\* Preheat oven

\*\* Preheat for 10 minutes

## Grilling

✓ Main oven

If you are grilling food directly on the wire rack, the universal pan should also be inserted at level 1. The liquid is then collected, keeping the oven cleaner.

Meal	Accessories and cookware	Level	Type of heating	Temperature in °C	Cooking time in minutes
Browning toast Preheat for 10 minutes	Wire rack + universal pan	3+1		3	1-2
Beefburgers, 12 pieces* (do not preheat)	Wire rack + universal pan	3+1		3	25-30

\* turn over after  $\frac{2}{3}$  of the cooking time.

BSH Hausgeräte GmbH  
Carl-Wery-Straße 34, 81739 München, GERMANY

[siemens-home.com](http://siemens-home.com)



9000722879 950218