

[en] Instruction manual2
[zh] 说明手册15



HF15M241W

Microwave
微波

保留备用

SIEMENS

en Table of contents

Important safety information	2	After-sales service	9
Causes of damage	4	E number and FD number	9
Installation and connection	5	Technical data	9
The control panel	5	Environmentally-friendly disposal	10
Rotary selector	6	Automatic programmes	10
Accessories	6	Setting a programme	10
Before using the appliance for the first time	6	Defrosting using the automatic programmes	10
Setting the clock	6	Cooking with the automatic programmes	10
The microwave	6	Tested for you in our cooking studio	11
Notes regarding ovenware	7	Information regarding the tables	11
Microwave power settings	7	Defrost	11
Setting the microwave	7	Defrosting, heating up or cooking frozen food	12
Cooling fan	7	Heating food	12
Memory	7	Cooking food	13
Saving memory settings	7	Microwave tips	13
Starting the memory	8	Test dishes in accordance with EN 60705	14
Care and cleaning	8	Cooking and defrosting with microwave	14
Cleaning agents	8		
Malfunction table	9		

Additional information on products, accessories, replacement parts and services can be found at www.siemens-home.bsh-group.com and in the online shop www.siemens-home.bsh-group.com/eshops

Important safety information

Read these instructions carefully. Only then will you be able to operate your appliance safely and correctly. Retain the instruction manual for future use or for subsequent owners.

Check the appliance for damage after unpacking it. Do not connect the appliance if it has been damaged in transport.

Only a licensed professional may connect appliances without plugs. Damage caused by incorrect connection is not covered under warranty.

This appliance is intended for domestic use only. The appliance must only be used for the preparation of food and drink. The appliance must be supervised during operation. Only use this appliance indoors.

This appliance is intended for use up to a maximum height of 4000 metres above sea level.

This appliance may be used by children over the age of 8 years old and by persons with reduced physical, sensory or mental capabilities or by persons with a lack of experience or knowledge if they are supervised or are instructed by a person

responsible for their safety how to use the appliance safely and have understood the associated hazards.

Children must not play with, on, or around the appliance. Children must not clean the appliance or carry out general maintenance unless they are at least 8 years old and are being supervised.

Keep children below the age of 8 years old at a safe distance from the appliance and power cable.

Risk of fire!

- The appliance becomes very hot. If the appliance is installed in a fitted unit with a decorative door, heat will accumulate when the decorative door is closed. Only operate the appliance when the decorative door is open.
- Combustible items stored in the cooking compartment may catch fire. Never store combustible items in the cooking compartment. Never open the appliance door if there is smoke inside. Switch off the

appliance and unplug it from the mains or switch off the circuit breaker in the fuse box.

- The appliance becomes very hot. Pay attention to the information in the section Installation and connection regarding minimum clearances for the appliance. The appliance must not be installed in a fitted unit.
- Using the appliance for anything other than its intended purpose is dangerous and may cause damage.
The following is not permitted: drying out food or clothing, heating slippers, grain or cereal pillows, sponges, damp cleaning cloths or similar.
For example, heated slippers and grain or cereal pillows may catch fire, even several hours after they have been heated. The appliance must only be used for the preparation of food and drinks.
- Food may catch fire. Never heat food in heat-retaining packages.
Do not leave food heating unattended in containers made of plastic, paper or other combustible materials.
Do not select a microwave power or time setting that is higher than necessary. Follow the information provided in this instruction manual.
Never use the microwave to dry food.
Never defrost or heat food with a low water content, e.g. bread, at too high a microwave power or for too long.
- Cooking oil may catch fire. Never use the microwave to heat cooking oil on its own.

Risk of explosion!

Liquids and other food may explode when in containers that have been tightly sealed. Never heat liquids or other food in containers that have been tightly sealed.

Risk of serious damage to health!

- The surface of the appliance may become damaged if it is not cleaned properly. Microwave energy may escape. Clean the appliance on a regular basis, and remove any food residue immediately. Always keep the cooking compartment, door seal, door and door stop clean; see also section Care and cleaning.
- Microwave energy may escape if the cooking compartment door or the door seal is damaged. Never use the appliance if the

cooking compartment door or the door seal is damaged. Contact the after-sales service.

- Microwave energy will escape from appliances that do not have any casing. Never remove the casing. For any maintenance or repair work, contact the after-sales service.

Risk of electric shock!

- Incorrect repairs are dangerous. Repairs may only be carried out and damaged power cables replaced by one of our trained after-sales technicians. If the appliance is defective, unplug the appliance from the mains or switch off the circuit breaker in the fuse box. Contact the after-sales service.
- The cable insulation on electrical appliances may melt when touching hot parts of the appliance. Never bring electrical appliance cables into contact with hot parts of the appliance.
- Do not use any high-pressure cleaners or steam cleaners, which can result in an electric shock.
- Penetrating moisture may cause electric shock. Never subject the appliance to intense heat or humidity. Only use this appliance indoors.
- A defective appliance may cause electric shock. Never switch on a defective appliance. Unplug the appliance from the mains or switch off the circuit breaker in the fuse box. Contact the after-sales service.
- The appliance is a high-voltage appliance. Never remove the casing.

Risk of burns!

- The appliance becomes very hot. Never touch the interior surfaces of the cooking compartment or the heating elements. Always allow the appliance to cool down. Keep children at a safe distance.
- Accessories and ovenware become very hot. Always use oven gloves to remove accessories or ovenware from the cooking compartment.
- Alcoholic vapours may catch fire in the hot cooking compartment. Never prepare food containing large quantities of drinks with a high alcohol content. Only use small quantities of drinks with a high alcohol content. Open the appliance door with care.
- Foods with peel or skin may burst or explode during, or even after, heating. Never cook eggs in their shells or reheat hard-boiled eggs. Never cook shellfish or

crustaceans. Always prick the yolk when baking or poaching eggs. The skin of foods that have a peel or skin, such as apples, tomatoes, potatoes and sausages, may burst. Before heating, prick the peel or skin.

- Heat is not distributed evenly through baby food. Never heat baby food in closed containers. Always remove the lid or teat. Stir or shake well after the food has been heated. Check the temperature of the food before it is given to the child.
- Heated food gives off heat. The ovenware may become hot. Always use oven gloves to remove ovenware or accessories from the cooking compartment.
- Airtight packaging may burst when food is heated. Always observe the instructions on the packaging. Always use oven gloves to remove dishes from the cooking compartment.

Risk of scalding!

- When you open the appliance door, hot steam may escape. Open the appliance door with care. Keep children at a safe distance.
- Water in a hot cooking compartment may create hot steam. Never pour water into the hot cooking compartment.
- There is a possibility of delayed boiling when a liquid is heated. This means that the liquid reaches boiling temperature without the usual steam bubbles rising to the surface. Even if the container only vibrates a little, the hot liquid may suddenly boil over and spatter. When heating, always place a spoon in the container. This will prevent delayed boiling.

Risk of injury!

- Scratched glass in the appliance door may develop into a crack. Do not use a glass scraper, sharp or abrasive cleaning aids or detergents.
- Unsuitable ovenware may crack. Porcelain or ceramic ovenware can have small perforations in the handles or lids. These perforations conceal a cavity below. Any moisture that penetrates this cavity could cause the ovenware to crack. Only use microwave-safe ovenware.
- If using the appliance in microwave mode only, placing cookware and containers made of metal inside the appliance may cause sparks when the appliance is operating. This will damage the appliance.

Never use metal containers when using the appliance in microwave mode only.

Causes of damage

Caution!

- Heavily soiled seal: If the seal is very dirty, the appliance door will no longer close properly during operation. The fronts of adjacent units could be damaged. Always keep the seal clean.
- Operating the microwave without food: Operating the appliance without food in the cooking compartment may lead to overloading. Never switch on the appliance unless there is food in the cooking compartment. An exception to this rule is a short crockery test (see the section "Microwave, suitable crockery").
- Microwave popcorn: Never set the microwave power too high. Use a power setting no higher than 600 watts. Always place the popcorn bag on a glass plate. The disc may jump if overloaded.
- Liquid that has boiled over must not be allowed to run through the turntable drive into the interior of the appliance. Monitor the cooking process. Choose a shorter cooking time initially, and increase the cooking time as required.
- Never use the microwave oven without the turntable.
- Creation of sparks: Metal - e.g. a spoon in a glass - must be kept at least 2 cm from the oven walls and the inside of the door. Sparks could irreparably damage the glass on the inside of the door.
- Foil containers: Do not use foil containers in the appliance. They damage the appliance by producing sparks.
- Cooling with the appliance door open: Only leave the cooking compartment to cool with the door closed. Do not trap anything in the appliance door. Even if the door is only slightly ajar, the fronts of adjacent units may be damaged over time.
- Condensation in the cooking compartment: Condensation may appear on the door window, interior walls and floor. This is normal and does not adversely affect microwave operation. To prevent corrosion, wipe off the condensation every time you cook.

Installation and connection

This appliance is intended for domestic use only.

Place the tabletop appliance on a firm, level surface (at least 85 cm above the floor). The ventilation slots at the rear, top and bottom of the appliance must not be obstructed. The minimum height of the free space above the surface of the appliance is 30 cm.

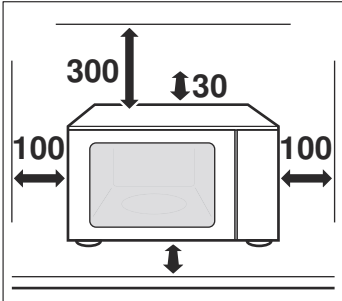

The appliance is fitted with a plug and must only be connected to a properly-installed earthed socket. The fuse protection must be rated at 10 amperes (L or B circuit breakers). The mains voltage must correspond to the voltage specified on the rating plate.

The socket must be installed and the power cable replaced by a qualified electrician only. The appliance plug must always be accessible.

Do not use multiple plugs, power strips or extension leads. Overloading results in a risk of fire.

Notes

- You can fasten your microwave appliance directly to the underside of a wall cupboard in the kitchen. Refer to the special mounting template.
- Compliance with the minimum height of the free space above the surface of the appliance (30 cm) does not apply to under-counter models.

The control panel

Here, you will see an overview of the control panel. Depending on the appliance model, there may be differences in the particular details.

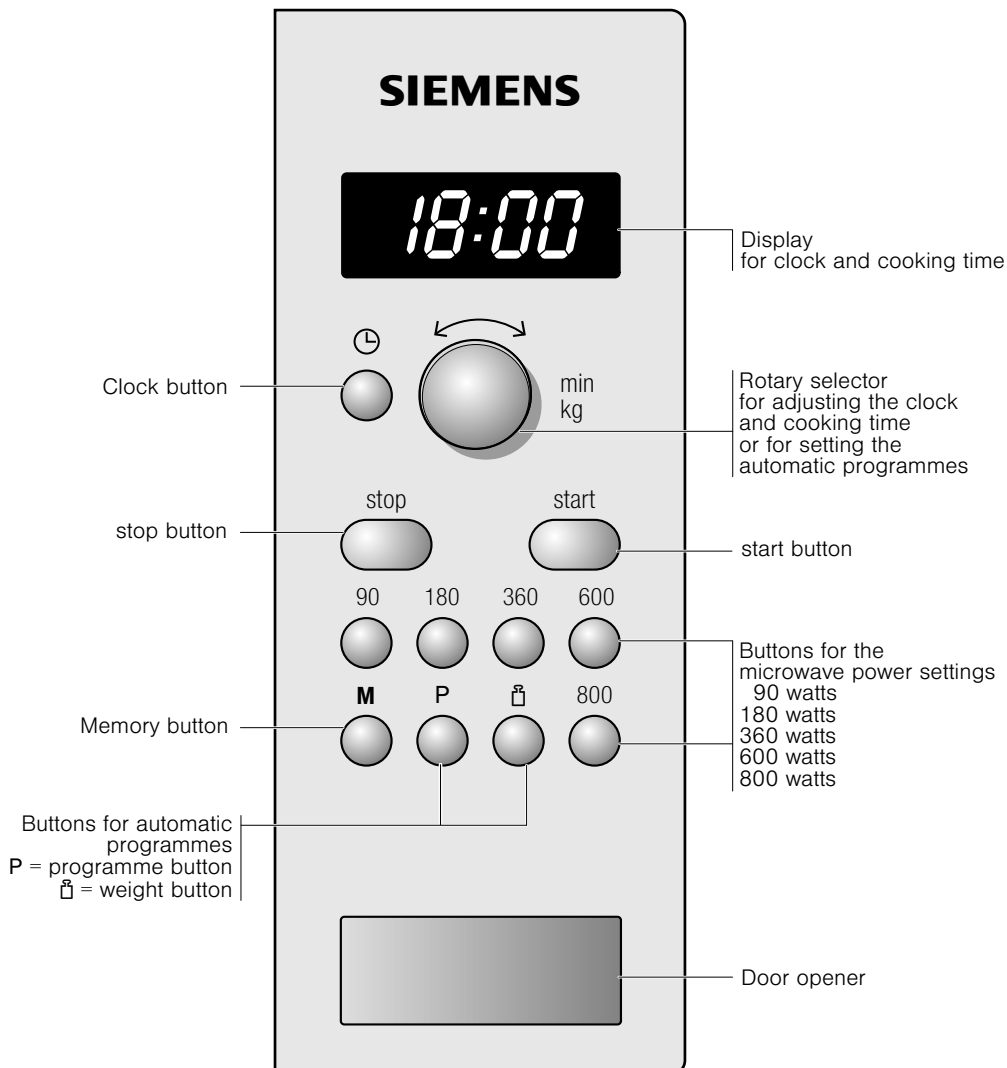

Rotary selector

The rotary selector is used to alter the default values and set values.

The rotary selector is retractable. Press on the rotary selector to lock it in or out.

Accessories

Caution!

When removing dishes, make sure that the turntable does not move. Make sure that the turntable is properly locked. The turntable can turn left or right.

The turntable

How to fit the turntable:

1. Place the turntable ring **a** in the recess in the cooking compartment.
2. Let the turntable **b** slot in place in the drive **c** in the centre of the cooking compartment floor.

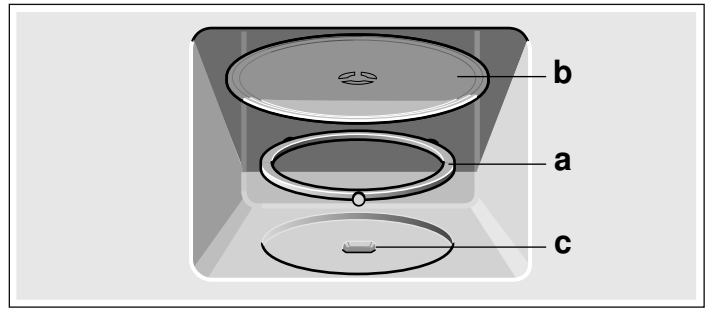

Note: Do not use the appliance if the turntable is not in place. Ensure that it is properly slotted into place. The turntable can turn clockwise or anti-clockwise.

Special accessories

You can purchase special accessories from the after-sales service or specialist retailers. Please specify the HZ number. You will find a comprehensive range of products in our brochures and on the Internet. The availability of special accessories and whether it is possible to order them online may vary depending on your country. Please see the sales brochures for more details.

Steamer ovenware



HZ 86 D 000

Before using the appliance for the first time

Here you will find everything you need to do before using the microwave to prepare food for the first time. First read the section on Safety information.

Setting the clock

When the appliance is first connected or after a power cut, three zeros will appear in the display panel.

1. Press the  button.
"12:00" and  appear in the display.
2. Set the clock using the rotary selector.

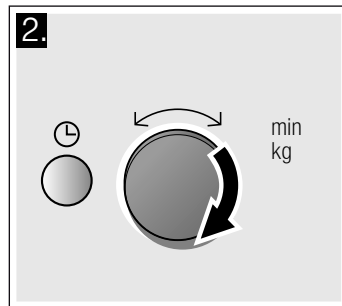
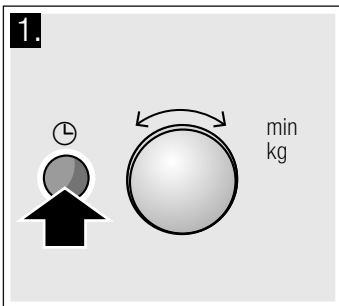

3. Press the  button again.

The current time is set.

Hiding the clock

Press the  button and then press Stop.
The display is blank.

Resetting the clock

Press the  button.
"12:00" appears in the display. Make settings as detailed in points 2 and 3.

Change the clock, e.g. from summer to winter time

Set as described in point 1 to 3.

The microwave

Microwaves are converted to heat in foodstuffs. You will find information about ovenware and how to set the microwave.

Note: In the Tested for you in our cooking studio section, you will find examples for defrosting, heating and cooking with the microwave oven.

Try out the microwave straight away. You could heat up a cup of water for your tea, for example.

Use a large cup without any decorative gold or silver trim and place a teaspoon in it. Place the cup containing the water on the turntable.

1. Press 800 W.

2. Set 1:30 minutes using the rotary knob.

3. Press the "start" button.

After 1 minute 30 seconds, a signal sounds. The water is hot.

As you are drinking your tea, please take time to read again the safety information that can be found at the front of the instruction manual. This is very important.

Notes regarding ovenware

Suitable ovenware

Suitable dishes are heat-resistant ovenware made of glass, glass ceramic, porcelain, ceramic or heat-resistant plastic. These materials allow microwaves to pass through.

You can also use serving dishes. This saves you having to transfer food from one dish to another. You should only use ovenware with decorative gold or silver trim if the manufacturer guarantees that they are suitable for use in microwaves.

Unsuitable ovenware

Metal ovenware is unsuitable. Metal does not allow microwaves to pass through. Food in covered metal containers will remain cold.

Caution!

Creation of sparks: metal – e.g. a spoon in a glass – must be kept at least 2 cm from the oven walls and the inside of the door. Sparks could destroy the glass on the inside of the door.

Ovenware test

Do not switch on the microwave unless there is food inside. The following ovenware test is the only exception to this rule.

Perform the following test if you are unsure whether your ovenware is suitable for use in the microwave:

1. Heat the empty ovenware at maximum power for ½ to 1 minute.
2. Check the temperature occasionally during that time.

The ovenware should still be cold or warm to the touch.

The ovenware is unsuitable if it becomes hot or sparks are generated.

Microwave power settings

Use the button to set the desired microwave power.

90 W	For defrosting delicate foods
180 W	For defrosting and continued cooking
360 W	For cooking meat and heating delicate foods
600 W	For heating and cooking food
800 W	For heating liquids

Note: You can set the 800 W microwave power setting for 30 minutes, 600 W for 1 hour, the other power settings for 1 hour and 39 minutes respectively.

Setting the microwave

Example: microwave power setting of 600 watts

1. Press the required microwave power setting.

The selected microwave power setting lights up in the display, and "1:00 min" appears.

2. Set a cooking time using the rotary selector.

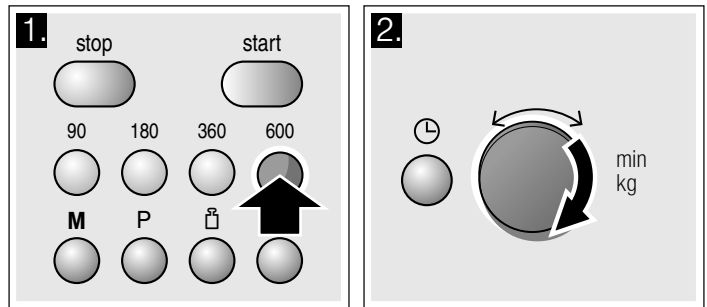

3. Press the start button.

The cooking time counts down in the display.

The cooking time has elapsed

A signal sounds. Open the appliance door or press Stop. The clock reappears.

Changing the cooking time

This can be done at any time. Change the cooking time using the rotary selector.

Pausing

Press the Stop button once, or open the appliance door. After closing, press the Start button again.

Cancelling operation

Press the Stop button twice, or open the door and press the Stop button once.

Note: You can also adjust the cooking time first and then the microwave power setting.

Cooling fan

The appliance is equipped with a cooling fan. The fan may run on even if the oven has been switched off.

Notes

- The cooking compartment remains cold during microwave operation. The cooling fan will still switch on. The fan may run on even when microwave operation has ended.
- Condensation may appear on the door window, interior walls and floor. This is normal and does not adversely affect microwave operation. Wipe away the condensation after cooking.

Memory

You can save the settings for a dish in the memory and call it up again at any time.

The memory is useful for if you frequently prepare a specific dish.

Saving memory settings

Example: 360 W, 25 minutes

1. Press the **M** button.

"M" appears in the display.

2. Press the required microwave power setting.

"M", the selected power setting and "1:00 min" appear in the display.

3. Set the cooking time using the rotary selector.

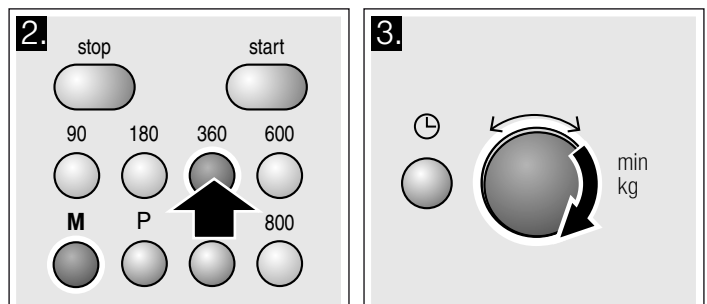

4. Confirm by pressing the **M** button.

The clock reappears. The setting is saved.

Notes

- You cannot save several microwave power settings one after the other.
- You cannot save automatic programmes.
- You can save the memory settings and start the appliance immediately. When finishing, instead of pressing **M**, press "start".
- **Saving a new setting in the memory:** press the **M** button. The old settings appear. Save the new programme as described in steps 1-4.

Starting the memory

It is very easy to start the saved programme. Place your meal into the appliance. Close the appliance door.

1. Press the **M** button.

The saved settings are displayed.

2. Press the start button.

The cooking time counts down in the display.

The cooking time has elapsed

A signal sounds. Open the appliance door or press Stop. The clock reappears.

Pausing

Press the Stop button once, or open the appliance door. After closing, press the Start button again.

Cancelling the setting

Press the Stop button twice, or open the appliance door and press the Stop button once.

Care and cleaning

With careful care and cleaning your microwave oven will retain its looks and remain good order. We will explain here how you should care for and clean your appliance correctly.

Risk of short circuit!

Never use high-pressure cleaners or steam cleaners to clean the oven.

Risk of burns!

Never clean the appliance immediately after switching off. Let the appliance cool down.

Risk of electric shock!

Do not immerse the appliance in water or clean under a jet of water.

Surfaces are different, and damage caused by using the wrong cleaning agent can be avoided by observing the information in the table below.

Do not use

- sharp or abrasive cleaning agents.
The surface could be damaged. If such a substance comes into contact with the front of the appliance, wash it off immediately with water.
- metal or glass scrapers to clean the glass in the appliance door.
- metal or glass scrapers for cleaning the seal.
- hard scouring pads or cleaning sponges.
Wash new sponge cloths thoroughly before use.
- cleaning agents with high concentrations of alcohol.

Cleaning agents

Caution!

Before cleaning, unplug the appliance from the mains or switch off the circuit breaker in the fuse box. Clean the outside of the appliance and the cooking compartment with a damp cloth and mild detergent. Dry with a clean cloth.

Area	Cleaning agents
Appliance front with stainless steel	Hot soapy water: Clean with a dish cloth and dry with a soft cloth. Remove flecks of limescale, grease, starch and albumin (e.g. egg white) immediately. Corrosion can form under such residues. Special stainless steel cleaning agents can be obtained from the after-sales service or from specialist shops. Do not use glass cleaners or metal or glass scrapers for cleaning.
Cooking compartment made of stainless steel	Hot soapy water or a vinegar solution: Clean with a dish cloth and dry with a soft cloth. If the oven is very dirty: use oven cleaner, but only when cooking compartment is cold. It is best to use a stainless-steel sponge. Do not use oven spray or other aggressive oven cleaners or abrasive materials. Scouring pads, rough sponges and pan cleaners are also unsuitable. These items scratch the surface. Allow the interior surfaces to dry thoroughly.
Recess in cooking compartment	Damp cloth: Ensure that no water seeps through the turntable drive into the appliance interior.
Turntable and turntable ring	Hot soapy water: When putting the turntable back in place, make sure it slots in correctly.
Door panels	Glass cleaner: Clean with a dish cloth. Do not use a glass scraper.
Seal	Hot soapy water: Clean with a dish cloth, do not scour. Do not use a metal or glass scraper for cleaning.

Area	Cleaning agents
Appliance front	Hot soapy water: Clean with a dish cloth and dry with a soft cloth. Do not use glass cleaners or metal or glass scrapers for cleaning.

Malfunction table

Malfunctions often have simple explanations. Please refer to the malfunction table before calling the after-sales service.

If a meal does not turn out exactly as you wanted, refer to the Tested for you in our cooking studio section, where you will find plenty of cooking tips and tricks.

Troubleshooting

Error message	Possible cause	Remedy/Note
The appliance does not work	The plug is not plugged into the mains.	Plug the plug in
	Power cut	Check whether the kitchen light works.
	Faulty circuit breaker	Look in the fuse box to make sure that the fuse for the appliance is OK.
	Incorrect operation	Switch off the circuit breaker in the fuse box. Reconnect it after approx. 10 seconds.
Three zeros flash in the display.	Power cut	Reset the time.
The appliance is not in operation. A cooking time appears in the display.	The rotary selector was accidentally pressed.	Press the "stop" button.
	The "start" button was not pressed after the setting was made.	Press the "start" button or clear the setting by pressing the "stop" button.
The microwave does not work.	The door was not fully closed.	Check whether food remains or foreign material is trapped in the door.
	The "start" button was not pressed.	Press the "start" button.
The food takes longer than usual to heat up	The microwave power setting was too low.	Select a higher microwave power setting.
	You have placed a larger amount of food than normal in the appliance.	Double the amount = double the cooking time.
	The food was colder than usual.	Stir or turn the food during cooking
The turntable is making a scratching or grinding noise.	There is dirt or a foreign object in the area around the turntable drive.	Clean the roller ring and recess in the cooking compartment.
Microwave operation has been cancelled for no apparent reason.	The microwave has a fault.	If this fault occurs repeatedly, please call the after-sales service.

Risk of electric shock!

Incorrect repairs are dangerous. Repairs may only be carried out by one of our trained after-sales engineers.

You can take remedial action yourself for some error messages.

After-sales service

Our after-sales service is there for you if your appliance needs to be repaired. We will always find the right solution in order to avoid unnecessary visits from a service technician.

E number and FD number

When calling us, please give the product number (E no.) and the production number (FD no.) so that we can provide you with the correct advice. The rating plate bearing these numbers can be found on the right-hand side when you open the appliance door. To save time, you can make a note of the number of your appliance and the telephone number of the after-sales service in the space below, should it be required.

E no.	FD no.

After-sales service 

Please note that there will be a fee for a visit by a service technician in the event of a malfunction, even during the warranty period.

Please find the contact data of all countries in the enclosed customer service list.

To book an engineer visit and product advice

- GB** 0344 892 8999
Calls charged at local or mobile rate.
- IE** 01450 2655
0.03 € per minute at peak. Off peak 0.0088 € per minute.

Rely on the professionalism of the manufacturer. You can therefore be sure that the repair is carried out by trained service technicians who carry original spare parts for your appliances.

This appliance corresponds to the standards EN 55011 and CISPR 11. It is a Group 2, Class B product.

Group 2 means that microwaves are produced for the purpose of heating food. Class B states that the appliance is suitable for private households.

Technical data

Input voltage	220 V, 50 Hz
Power consumption	1270 W
Maximum output power	800 W
Microwave frequency	2450 MHz
Fuse	10 A

Dimensions (HxWxD)

- appliance	290 x 461 x 351 mm
- cooking compartment	194 x 290 x 300 mm
VDE approved	yes
CE mark	yes

Environmentally-friendly disposal

Dispose of packaging in an environmentally-friendly manner.



This appliance is labelled in accordance with European Directive 2012/19/EU concerning used electrical and electronic appliances (waste electrical and electronic equipment - WEEE). The guideline determines the framework for the return and recycling of used appliances as applicable throughout the EU.

Automatic programmes

You can use the automatic programmes to defrost food with the greatest of ease and prepare dishes quickly and easily. You select the programme and enter the weight of your food. The automatic programme makes the optimum setting. You can select from 7 programmes.

Setting a programme

Once you have selected a programme, make settings as follows:

1. Press the P button repeatedly until the required programme number appears.

2. Press the  button.

"P" and a default weight appear in the display.

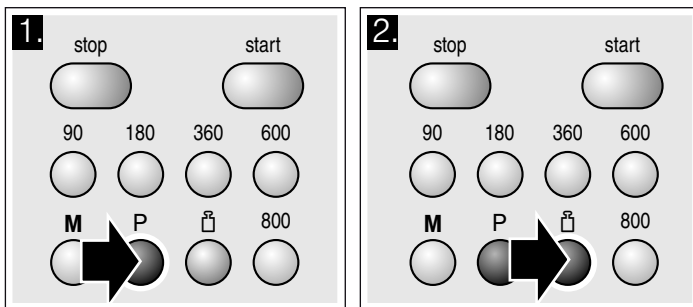

3. Turn the rotary selector to specify the weight of the dish.

4. Press the start button.

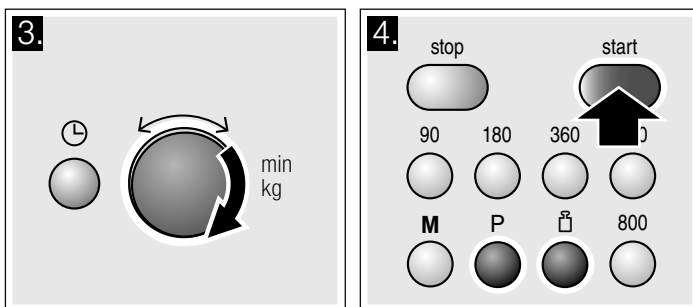

You will see the cooking time for the programme counting down.

The cooking time has elapsed

A signal sounds. Open the appliance door or press Stop. The clock reappears.

Correction

Press the Stop button twice and reset.

Pausing

Press the Stop button once, or open the appliance door. After closing, press the Start button again.

Cancelling

Press the "stop" button twice, or open the door and press the "stop" button once.

Notes

- For some programmes, a signal sounds after a certain time. Open the appliance door and stir the food or turn the meat or poultry. After closing the door, press the "start" button again.
- You can query the programme number and weight using "P" or . The queried value is shown for 3 seconds in the display.

Defrosting using the automatic programmes

You can use the 4 defrosting programmes to defrost meat, poultry and bread.

Notes

■ Preparing food

Use food that has been frozen at -18 °C and stored in portion-sized quantities that are as thin as possible.

Take the food to be defrosted out of all packaging and weigh it. You need to know the weight to set the programme.

- Liquid will be produced when defrosting meat or poultry. Drain off this liquid when turning meat and poultry and under no circumstances use it for other purposes or allow it to come into contact with other foods.

■ Ovenware

Place the food in a microwaveable shallow dish, e.g. a china or glass plate, but do not cover.

■ Resting time

The defrosted food should be left to stand for an additional 10 to 30 minutes until it reaches an even temperature. Large pieces of meat require a longer standing time than smaller pieces. Flat pieces of meat and items made from minced meat should be separated from each other before leaving to stand.

After this time, you can continue to prepare the food, even though thick pieces of meat may still be frozen in the middle. The giblets can be removed from poultry at this point.

■ Signal

For some programmes, a signal sounds after a certain time. Open the appliance door and separate the food out or turn the meat or poultry. Close the door and press the Start button.

Programme no.		Weight range in kg
	Defrost	
P 01	Minced meat	0.20 - 1.00
P 02	Pieces of meat	0.20 - 1.00
P 03	Chicken, chicken pieces	0.40 - 1.80
P 04	Bread	0.20 - 1.00

Cooking with the automatic programmes

With the 3 cooking programmes, you can cook rice, potatoes or vegetables.

Notes

■ Ovenware

The food must be cooked in microwaveable cookware with a lid. For rice, you should use a large, deep dish.

■ Preparing food

Weigh out the food. You need to know the weight to set the programme.

Rice:

Do not use boil-in-the-bag rice. Add the required amount of water, as specified on the packaging. This is usually two or three times the quantity of rice.

Potatoes:

For boiled potatoes, cut the fresh potatoes into small, even-sized pieces. Add one tablespoon of water for each 100 g boiled potatoes, and a little salt.

Fresh vegetables:

Weigh out the fresh, trimmed vegetables. Cut the vegetables into small, even-sized pieces. Add a tbsp water for each 100 g vegetables.

■ Signal

While the programme is running, a signal sounds after some time. Stir the food.

■ Resting time

Once the programme has finished, stir the food again. You should leave it to stand for another 5 to 10 minutes until it reaches an even temperature.

The cooking result will depend on the quality and consistency of the food.

Programme no.		Weight range in kg
	Cooking	
P 05	Rice	0.05 - 0.2
P 06	Potatoes	0.15 - 1.0
P 07	Vegetables	0.15 - 1.0

Tested for you in our cooking studio

Here you will find a selection of recipes and the ideal settings for them. We show you which microwave power setting is best suited to your dish. There are also tips about ovenware and preparation methods.

Information regarding the tables

The following tables provide you with numerous options and settings for the microwave.

The times specified in the tables are only guidelines. They may vary according to the ovenware used, the quality, temperature and consistency of the food.

Time ranges are often specified in the tables. Set the shortest time first and then extend the time if necessary.

It may be that you have different quantities from those specified in the tables. A rule of thumb can be applied:

Double the amount - almost twice the cooking time

Half the amount - half the cooking time.

Always place the ovenware on the turntable.

Defrost

Notes

- Place the frozen food in an open container on the turntable.
- Delicate parts such as the legs and wings of chicken or fatty outer layers of roasts can be covered with small pieces of aluminium foil. The foil must not touch the oven walls. You can remove the foil half way through the defrosting time.
- Liquid will be produced when defrosting meat or poultry. Drain off this liquid when turning meat and poultry and under no circumstances use it for other purposes or allow it to come into contact with other foods.
- Turn or stir the food once or twice during the defrosting time. Large pieces of food should be turned several times.
- Leave defrosted items to stand at room temperature for a further 10 to 20 minutes so that the temperature is even throughout. The giblets can be removed from poultry at this point. The meat can still be further prepared, even if it has a small frozen core.

Defrost	Weight	Microwave power setting in watts, cooking time in minutes	Notes
Whole pieces of meat (beef, veal or pork - on the bone or boned)	800 g	180 W, 15 mins + 90 W, 10-20 mins	-
	1 kg	180 W, 20 mins + 90 W, 15-25 mins	
	1.5 kg	180 W, 30 mins + 90 W, 20-30 mins	
Meat in pieces or slices of beef, veal or pork	200 g	180 W, 2 mins + 90 W, 4-6 mins	Separate any defrosted parts when turning
	500 g	180 W, 5 mins + 90 W, 5-10 mins	
	800 g	180 W, 8 mins + 90 W, 10-15 mins	
Minced meat, mixed	200 g	90 W, 10 mins	Freeze food flat if possible Turn several times, remove any defrosted meat
	500 g	180 W, 5 mins + 90 W, 10-15 mins	
	800 g	180 W, 8 mins + 90 W, 10-20 mins	
Poultry or poultry portions	600 g	180 W, 8 mins + 90 W, 10-15 mins	-
	1.2 kg	180 W, 15 mins + 90 W, 20-25 mins	
Fish fillet, fish steak or slices	400 g	180 W, 5 mins + 90 W, 10-15 mins	Separate any defrosted parts
Vegetables, e.g. peas	300 g	180 W, 10-15 mins	-
Fruit, e.g. raspberries	300 g	180 W, 7-10 mins	Stir carefully during defrosting and separate any defrosted parts
	500 g	180 W, 8 mins + 90 W, 5-10 mins	
Butter, defrosting	125 g	180 W, 1 min. + 90 W, 2-3 mins	Remove all packaging
	250 g	180 W, 1 min + 90 W, 3-4 mins	

Defrost	Weight	Microwave power setting in watts, cooking time in minutes	Notes
Loaf of bread	500 g	180 W, 6 mins + 90 W, 5-10 mins	-
	1 kg	180 W, 12 mins + 90 W, 10-20 mins	
Cakes, dry, e.g. sponge cake	500 g	90 W, 10-15 mins	Only for cakes without icing, cream or crème pâtissière, separate the pieces of cake
	750 g	180 W, 5 mins + 90 W, 10-15 mins	
Cakes, moist, e.g. fruit flan, cheese-cake	500 g	180 W, 5 mins + 90 W, 15-20 mins	Only for cakes without icing, cream or gelatine
	750 g	180 W, 7 mins + 90 W, 15-20 mins	

Defrosting, heating up or cooking frozen food

Notes

- Take ready meals out of the packaging. They will heat up more quickly and evenly in microwaveable ovenware. The different components of the meal may not require the same amount of time to heat up.
- Food which lies flat will cook more quickly than food which is piled high. You should therefore distribute the food so that it is as flat as possible in the ovenware. Different foodstuffs should not be placed in layers on top of one another.

- Always cover the food. If you do not have a suitable cover for your ovenware, use a plate or special microwave foil.
- Stir or turn the food 2 or 3 times during cooking.
- After heating, allow the food to stand for a further 2 to 5 minutes so that it can achieve an even temperature.
- Always use an oven cloth or oven gloves when removing plates from the oven.
- This will help the food retain its own distinct taste, so it will require less seasoning.

Defrosting, heating up or cooking frozen food	Weight	Microwave power setting in watts, cooking time in minutes	Notes
Menu, plated meal, ready meal (2-3 components)	300-400 g	600 W, 8-11 mins	-
Soup	400 g	600 W, 8-10 mins	-
Stews	500 g	600 W, 10-13 mins	-
Slices or pieces of meat in sauce, e.g. goulash	500 g	600 W, 12-17 mins	Separate the pieces of meat when stirring
Fish, e.g. fillet steaks	400 g	600 W, 10-15 mins	Add water, lemon juice or wine as desired
Bakes, e.g. lasagne, cannelloni	450 g	600 W, 10-15 mins	-
Side dishes, e.g. rice, pasta	250 g	600 W, 2-5 mins	Add a little liquid
	500 g	600 W, 8-10 mins	
Vegetables, e.g. peas, broccoli, carrots	300 g	600 W, 8-10 mins	Pour water into the dish so that it covers the base
	600 g	600 W, 14-17 mins	
Creamed spinach	450 g	600 W, 11-16 mins	Cook without additional water

Heating food

⚠ Risk of scalding!

There is a possibility of delayed boiling when a liquid is heated. This means that the liquid reaches boiling temperature without the usual steam bubbles rising to the surface. Even if the container only moves a little, the hot liquid can suddenly boil over and spatter. When heating liquids, always place a spoon in the container. This will prevent delayed boiling.

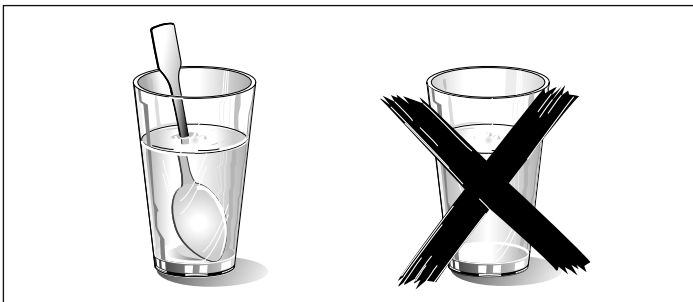

Caution!

Metal - e.g. a spoon in a glass - must be kept at least 2 cm from the oven walls and the inside of the door. Sparks could irreparably damage the glass on the inside of the door.

Notes

- Take ready meals out of the packaging. They will heat up more quickly and evenly in microwaveable ovenware. The different components of the meal may not require the same amount of time to heat up.
- Always cover the food. If you do not have a suitable cover for your container, use a plate or special microwave foil.
- Stir or turn the food several times during the heating time. Check the temperature.
- After heating, allow the food to stand for a further 2 to 5 minutes so that it can achieve an even temperature.
- Always use an oven cloth or oven gloves when removing plates from the oven.

Heating food	Weight	Microwave power setting in watts, cooking time in minutes	Notes
Menu, plated meal, ready meal (2-3 components)	350-500 g	600 W, 4-8 mins	-

Heating food	Weight	Microwave power setting in watts, cooking time in minutes	Notes
Drinks	150 ml	800 W, 1-2 mins	Place a spoon in the glass; do not overheat alcoholic drinks; check during heating
	300 ml	800 W, 2-3 mins	
	500 ml	800 W, 3-4 mins	
Baby food, e.g. baby bottle	50 ml	360 W, approx. ½ min	No teats or lids. Always shake well after heating. You must check the temperature.
	100 ml	360 W, approx. 1 min.	
	200 ml	360 W, 1½ min	
Soup 1 cup	200 g	600 W, 2-3 mins	-
Soup, 2 cups	400 g	600 W, 4-5 mins	-
Meat in sauce	500 g	600 W, 8-11 mins	Separate the slices of meat
Stew	400 g	600 W, 6-8 mins	-
	800 g	600 W, 8-11 mins	-
Vegetables, 1 portion	150 g	600 W, 2-3 mins	Add a little liquid
Vegetables, 2 portions	300 g	600 W, 3-5 mins	

Cooking food

Notes

- Food which lies flat will cook more quickly than food which is piled high. You should therefore distribute the food so that it is as flat as possible in the ovenware. Different foodstuffs should not be placed in layers on top of one another.

- Cook the food in ovenware with a lid. If you do not have a suitable lid for your ovenware, use a plate or special microwave foil.
- This will help the food retain its own distinct taste, so it will require less seasoning.
- After cooking, allow the food to stand for a further 2 to 5 minutes so that it can achieve an even temperature.
- Always use an oven cloth or oven gloves when removing plates from the oven.

Cooking food	Weight	Microwave power setting in watts, cooking time in minutes	Notes
Meat loaf	750 g	600 W, 20-25 mins	Cook uncovered
Whole chicken, fresh, no giblets	1.2 kg	600 W, 25-30 mins	Turn halfway through the cooking time
Fresh vegetables	250 g	600 W, 5-10 mins	Cut vegetables into pieces of equal size. Add 1 to 2 tbsp water per 100 g of vegetables. Stir during cooking
	500 g	600 W, 10-15 mins	
Potatoes	250 g	600 W, 8-10 mins	Cut potatoes into pieces of equal size; Add 1 to 2 tbsp water for every 100 g. Stir during cooking
	500 g	600 W, 11-14 mins	
	750 g	600 W, 15-22 mins	
Rice	125 g	800 W, 5-7 mins + 180 W, 12-15 mins	Add double the quantity of liquid.
	250 g	800 W, 6-8 mins + 180 W, 15-18 mins	
Sweet foods, e.g. blancmange (instant)	500 ml	600 W, 6-8 mins	Stir the custard pudding thoroughly 2 to 3 times during cooking using an egg whisk.
Fruit, compote	500 g	600 W, 9-12 mins	-

Microwave tips

You cannot find any information about the settings for the quantity of food you have prepared.

Increase or reduce the cooking times using the following rule of thumb:

Double the amount = almost double the cooking time

Half the amount = half the cooking time

The food has become too dry.

Next time, set a shorter cooking time or select a lower microwave power setting. Cover the food and add more liquid.

When the time has elapsed, the food is not defrosted, hot or cooked.

Set a longer time. Large quantities and food which is piled high require longer times.

When the time has elapsed, the food is overheated at the edge but not done in the middle.

Stir it during the cooking time and next time, select a lower microwave power setting and a longer cooking time.

After defrosting, the poultry or meat is defrosted on the outside but not defrosted in the middle.

Next time, select a lower microwave power setting. If you are defrosting a large quantity, turn it several times.

Condensation

Condensation may appear on the door window, interior walls and floor. This is normal. This does not affect how the microwave operates. Wipe away the condensation after cooking.

Test dishes in accordance with EN 60705

The quality and correct operation of microwave appliances are tested by testing institutes using these dishes.

In accordance with EN 60705, IEC 60705, DIN 44547 and EN 60350 (2009)

Cooking and defrosting with microwave

Microwave cooking

Dish	Microwave setting (watts) and cooking time in minutes	Notes
Custard, 565 g	180 watts, 25-30 mins + 90 watts, 20-25 mins	Place the 20 x 17 cm Pyrex dish on the turntable.
Sponge	600 watts, 8-10 mins	Place the Ø 22 cm Pyrex dish on the turntable.
Meatloaf	600 watts, 20-25 mins	Place the Pyrex dish on the turntable.

Microwave defrosting

Dish	Microwave setting (watts) and cooking time in minutes	Note
Meat	180 watts, 5-7 mins + 90 watts, 10-15 mins	Place the Ø 22 cm Pyrex dish on the turntable.

重要安全信息	15
损坏原因	16
安装和连接	17
控制面板	17
旋转选择钮	18
附件	18
在第一次使用电器之前	18
设置时钟	18
微波	18
关于烹饪容器的注意事项	18
微波功率设置	19
设置微波	19
冷却风扇	19
记忆	19
保存存储器设置	19
启动存储器	19
保养和清洁	20
清洁剂	20
故障表	20

售后服务	21
E 编号和 FD 编号	21
技术参数	21
环保 处置	21
自动烹饪程序	21
设置程序	21
使用自动程序解冻	22
使用自动程序烹饪	22
经由 我们烹饪工作室测试过的菜谱	22
参考表格相关说明	22
解冻	22
解冻、加热或烹饪冷冻食品	23
加热食物	23
烹饪食物	24
微波使用技巧	24
符合 EN 60705 标准的测试菜谱	25
用微波烹饪和解冻	25

关于产品、附件、更换部件以及服务的更多信息请参见
www.siemens-home.bsh-group.com 以及网上商店 www.siemens-home.bsh-group.com/eshops

⚠ 重要安全信息

请认真阅读本手册。只有这样才能安全正确地使用电器。请保管好本说明手册，以备日后使用或供下一任所有者使用。

拆包后请检查电器是否有损坏。如果电器在运输过程中损坏，请勿连接电器。

仅限持有上岗证书的专业人员才可以连接不带插头的电器。因不正确连接导致的损坏将不予保修。

本电器仅供家庭使用。本电器只能用于制备食物和饮料。电器工作时必须有人看管。本电器仅限室内使用。

本电器最高可在海拔 4000 米的高度使用。

8 岁以上儿童以及身体、感官或精神有缺陷的人员或缺乏经验和知识的人员，必须在有人监督的情况下或在安全责任人给予电器使用安全指导并了解相关危险的情况下，方可使用本电器。

严禁儿童玩耍本电器及在电器周围玩耍。儿童除非年满 8 岁并有人监督，否则不得清洁本电器或执行一般维护操作。

8 岁以下儿童请远离本电器和电源线。

有着火危险！

- 电器会变灼热。如果电器安装在有装饰门的固定橱柜中，装饰门关闭时会聚集热量。只能在装饰门打开时才能操作电器。
- 易燃物品保存在烹饪箱中可能导致着火危险。切勿将易燃的物品保存在烹饪箱中。切勿在内部起烟时打开电器门。关断电器，拔下电源插头，或关断熔断器盒中的断路器。
- 电器会变灼热。请注意安装和连接章节中关于电器最小间隙的信息。电器不得安装在固定橱柜中。
- 将本电器用于预定用途以外的其他目的非常危险，可能导致损坏。不允许以下行为：烘干食物或衣物，加热拖鞋或谷物枕头、海绵、湿的清洁布或类似物品。例如，加热的拖鞋和谷物或荞麦枕可能会着火，火灾甚至会在几小时以后发生。本电器只能用于制备食物和饮品。
- 食物可能着火。切勿在蓄热包装内加热食物。在无人看管的情况下，请勿将食物放在塑料、纸或其它易燃材料制成的容器中加热。所选择的微波功率或时间设置不要高于实际需要。请遵循本说明手册中提供的信息。切勿使用微波干燥食物。

解冻或加热含水量低的食物。如面包时，切勿选择过高的功率或过长的时间。

- 食用油有着火危险。切勿使用微波单独加热食用油。

有爆炸危险！

将液体或其它食物放在密封的容器中有爆炸危险。切勿将饮品或其它食物放在密封的容器中加热。

有严重损害健康的危险！

- 如果清洁不当，电器表面可能会损坏。微波能可能会逸出。定期清洁电器，并即时除去食物积垢。时刻保持烹饪箱、门封、门和门碰清洁；另请参见章节保养和清洁。
- 如果烹饪箱门或门封损坏，微波能可能会逸出。在烹饪箱门或门封损坏时，切勿使用本电器。联系售后服务部门。
- 如果电器没有配备任何外壳，微波能将会逸出。切勿拆除外壳。如有任何维护或维修工作，请联系售后服务部门。

有电击危险！

- 修理不当是很危险的。只能由我们经过培训的售后服务人员来维修电器和更换损坏的电源线。如果电器发生故障，请拔下电器电源插头，或断开熔断器盒中的断路器。联系售后服务部门。
- 如果接触到电器的灼热部件，电器的电线绝缘层会熔化。切勿使电器电源线接触电器的灼热部件。
- 请勿使用高压清洁剂或蒸汽清洁剂，以防触电。
- 湿气渗入会导致电击危险。切勿让电器处于过热或潮湿的环境中。本电器仅限室内使用。
- 故障电器会导致电击危险。切勿接通发生故障的电器。拔下电器的电源插头或断开保险丝盒中的断路器。联系售后服务部门。
- 本电器为高压电器。切勿拆除外壳。

有灼伤危险！

- 电器会变灼热。切勿触摸烹饪箱的内表面或加热元件。必须让电器冷却下来。请将小孩留在安全距离以外。
- 附件和烹饪容器会变得十分灼热。从烹饪箱中取出附件或烹饪容器时必须戴上烤箱手套。
- 酒精蒸汽可能会在热烹饪箱内着火。切勿烹饪混合了大量高浓度酒类的食物。只能使用少量高浓度酒类。打开电器门时需小心。
- 带壳或带皮的食物在加热过程中或甚至在加热后都有可能爆裂或爆炸。切勿加热带壳的鸡蛋或重新加热白煮蛋。切勿烹饪贝类或甲壳类。在煎蛋或水煮蛋时，一定要刺破蛋黄。带壳或带皮的食物表皮会爆裂，如苹

果、番茄、土豆和香肠。加热前，应先刺破表壳或表皮。

- 婴儿食品中热量分布不均。切勿在封闭的容器中加热婴儿食品。一定要取下盖子或奶嘴。食物经过加热后，要搅拌或摇晃均匀。在喂孩子食物之前要先检查食物的温度。
- 经过加热的食物会散发热量。烹饪容器会变热。从烹饪箱中取出烹饪容器或附件时必须戴上烤箱手套。
- 给食物加热时，密封的包装可能会爆炸。请遵守产品包装上的说明。将容器从烹饪箱中取出时一定要戴上烤箱手套。

有烫伤危险！

- 在打开电器门时，可能会有热蒸汽逸出。打开电器门时需小心。请将小孩留在安全距离以外。
- 将水倒入高温烹饪箱会产生热蒸汽。切勿将水倒入高温烹饪箱中。
- 加热的液体有可能延时沸腾。即液体达到沸腾温度后，却没有常见的蒸汽气泡冒出液面。即使容器只是稍微振动，滚烫的液体也会突然沸腾溢出和飞溅。在加热时，一定要在容器内放一把汤匙。这会防止延时沸腾。

有受伤危险！

- 电器门玻璃如果有刮伤，可能会导致裂开。请不要使用玻璃刮刀、剧烈或腐蚀性的清洁用品或洗涤剂。
- 不合适的烹饪容器可能会开裂。瓷质或陶质烹饪容器在手柄或盖上会有小孔。这些小孔下方隐藏着空穴。渗入这些空穴的液体可能导致烹饪容器破裂。仅限使用耐微波烹饪容器。
- 若电器仅使用微波模式，放置于内部由金属制成的厨具和容器在电器运作时可能会产生火花。这会导致电器损坏。电器仅使用微波模式时切勿使用金属容器

损坏原因

注意！

- 门封严重脏污：如果门封非常脏，电器门在操作过程中将无法正确关闭。附近橱柜的表面可能会损坏。应始终保持门封清洁。
- 在未放食物时使用微波：烹饪箱中未放食物就操作电器会导致电器过载。如果烹饪箱中没有食物，切勿接通电器。但短时期皿测试不受此影响（参见“微波适用容器”一节）。
- 微波爆米花：切勿将微波功率设置得过高。功率设置不要超过 600 W。爆米花袋必须放在玻璃盘上。转盘过载时可能会跳动。
- 确保沸腾溢出的液体不会经过转盘驱动装置流入电器内部。监视烹饪过程。开始时选择一个较短的烹饪时间，之后根据需要延长烹饪时间。
- 切勿在没有转盘的情况下使用微波炉。
- 产生火花：金属（例如玻璃杯内的汤匙）必须距离烹饪箱内壁和门内壁至少 2 cm。否则，火花会损坏门内壁的玻璃。
- 箔制容器：不要在电器中使用箔制容器。它们产生的火花会损坏电器。
- 打开电器门冷却：只能关上电器门让烹饪箱冷却。不要将任何东西夹在电器门中。否则，即使电器门只是略微开启，长时间下来，附近设备的表面也可能被损坏。

- 烹饪箱中产生冷凝水：门窗、内壁和底板上可能会出现冷凝液。这是正常现象，不影响微波工作。为防止电器腐蚀，每次烹饪时应擦净冷凝水。

安装和连接

本电器仅供家庭使用。

请将台式电器放置在坚固的水平台面（至少距离地面 85 cm）。电器后部、顶部和底部的通风槽不得堵塞。电器顶部空余空间的最小高度为 30 cm。

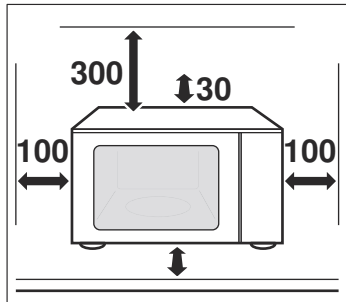

本电器装有插头，只能连接到带有正确接地措施的插座上。保险丝的额定电流保护值必须为 10 安培（L 或 B 型断路器）。供电电压必须与铭牌上的规定电压一致。

必须由电气专业人员安装插座和更换电源线。电器插头必须始终位于可触及的位置。

请勿同时使用多个插头、电源板或拖线板。过载会导致着火危险。

提示

- 您可将微波电器直接安装在厨房壁柜的底部。请参考特制安装样板。
- 下嵌式型号不需要遵守电器顶部空余空间的最小高度（30 cm）。

控制面板

下面是控制面板示意图。根据电器型号，特定细节可能不同。

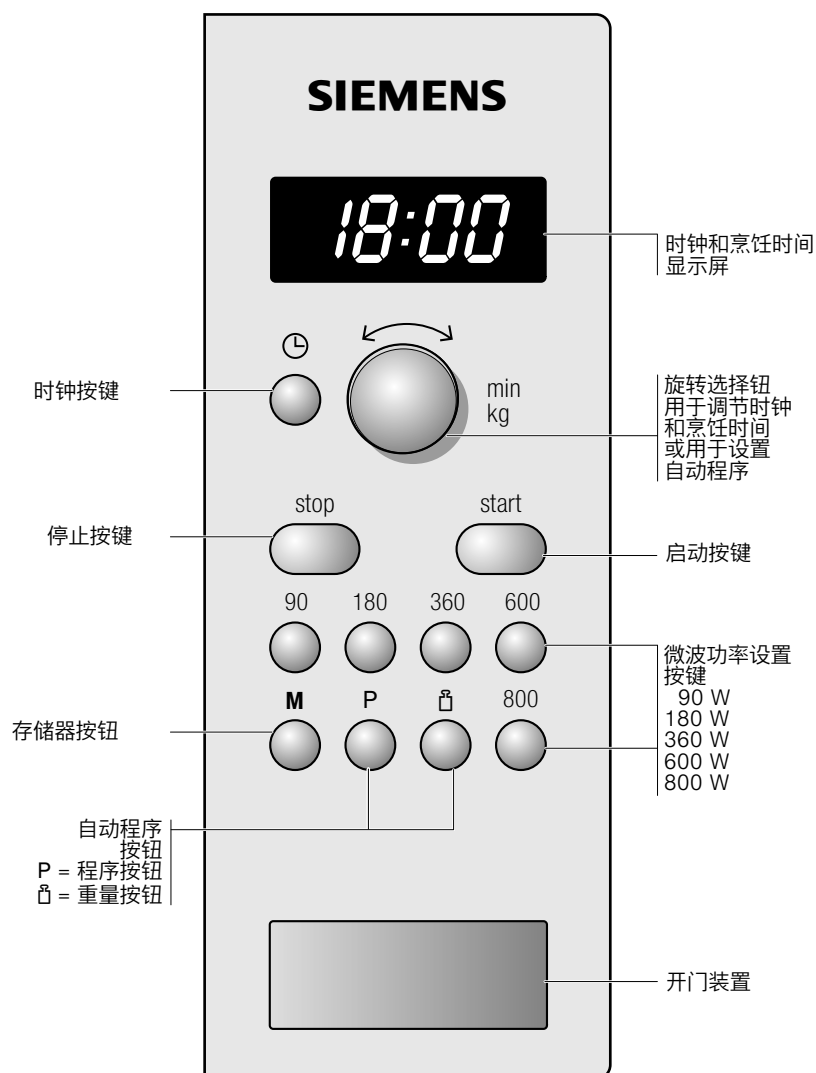

旋转选择钮

可使用旋转选择钮更改默认值和设定值。

旋转选择钮可掀起。按压旋转选择钮可将其锁定在掀起或弹出位置。

附件

注意！

取出盘子时，请确保转盘不移动。确保转盘正确锁止。转盘可向左或向右转动。

转盘

转盘安装步骤：

1. 将转盘垫圈 **a** 放入烹饪箱内的垫圈槽上。
2. 使转盘 **b** 的槽口与烹饪箱箱底中央处的驱动轴 **c** 卡合。

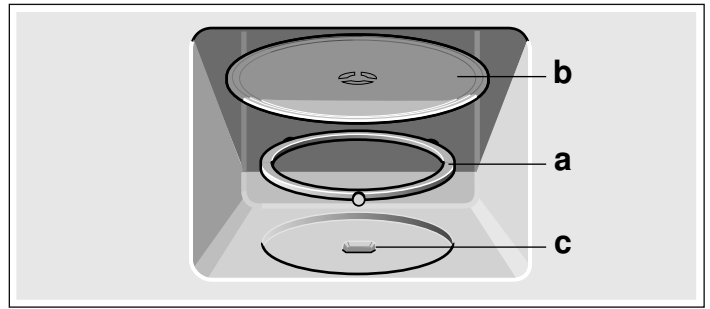

提示：若转盘未安装好，则不得使用电器。确保转盘卡入到位。转盘可顺时针或逆时针转动。

专用附件

您可以在售后服务部或专卖店购买专用附件。请指定 HZ 编号。您可在我们的手册和互联网上查找到一系列产品。是否提供专用附件以及是否可以在线订购取决于您所在国家。详细信息请参考销售手册。

蒸炉器皿

HZ 86 D 000

在第一次使用电器之前

本节介绍在第一次使用微波炉制备食物前需要进行的所有工作。首先阅读安全信息一章。

设置时钟

在电器初次接通时或在断电后，显示屏上将显示三个零。

1. 按下 按键。
“12:00”和 出现在显示屏中。
2. 使用旋转选择钮设置时钟。

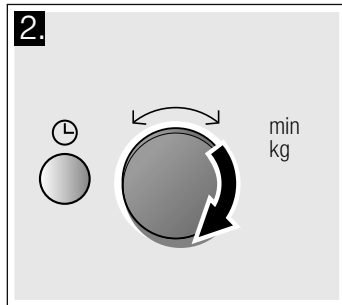
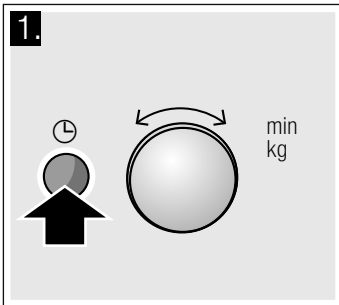

3. 再次按下 按键。

当前时间设置好。

隐藏时钟

按下 按钮，然后按下 Stop (停止) 按钮。
显示屏为空白。

重设时钟

按下 按键。
“12:00”出现在显示屏中。按照步骤 2 和 3 进行设置。

例如，将时钟从夏令时改为冬令时

按照步骤 1 到 3 进行设置。

微波

微波在食物中转化为热能。本节介绍烹饪容器和微波设置方法。

提示：在经由我们烹饪工作室测试过的菜谱一节中，您将可以找到有关使用微波解冻、加热和烹饪的示例。

立刻试用微波炉。例如，您可以加热一杯水，用来泡茶。

使用没有任何金饰边或银饰边的大杯，在其中放入一把茶匙。将这个装水的大杯子放在转盘上。

1. 按下 800 W。
 2. 使用旋钮设置为 1:30 分钟。
 3. 按下 Start (启动) 按钮。
- 1 分 30 秒后响起一个信号声。水已烧热。

在品茶的同时，请再花点时间阅读说明手册前面的安全信息。这些信息非常重要。

关于烹饪容器的注意事项

适用烹饪容器

用玻璃、玻璃陶瓷、陶瓷或耐热塑料制成的耐热烹饪容器均适用。这些材料允许微波通过。

也可以使用餐盘。这样就不用将食物从一个盘换到另一个盘。如果烹饪容器带有金饰边或银饰边，只有在制造商保证它们适用于微波时才能使用。

不适用烹饪容器

金属器皿不适用。金属不允许微波通过。放在金属容器中的食物仍是冷的。

注意！

产生火花：金属（例如玻璃杯内的汤匙）必须距离烹饪箱内壁和门内壁至少 2 cm。否则，火花会损坏门内壁的玻璃。

烹饪容器测试

只有在烹饪箱内放有食物的情况下才能开启微波。唯一的例外是进行下面的烹饪容器测试。

如果您不能确定自己的烹饪容器是否适合在微波中使用，则进行以下测试：

1. 以最大功率加热空烹饪容器 1/2 到 1 分钟。
2. 加热期间请不时查看温度。

烹饪容器摸起来应该仍是冷的或温的。

如果烹饪容器变热或产生火花，则不适用。

微波功率设置

使用按键设置需要的微波功率。

90 W	用于解冻精细食物
180 W	用于解冻和连续烹饪
360 W	用于烹饪肉类和加热精致食物
600 W	用于加热和烹饪食物
800 W	用于加热液体

提示：可以设置 30 分钟的 800 W 微波功率和 1 小时的 600 W 微波功率，以及 1 小时 39 分钟的其他微波功率。

设置微波

举例：微波功率设置为 600 W

1. 按下所需要的微波功率设置。
所选的微波功率设置在显示屏中变亮，同时显示“1:00 min”。
2. 使用旋转选择钮设置烹饪时间。

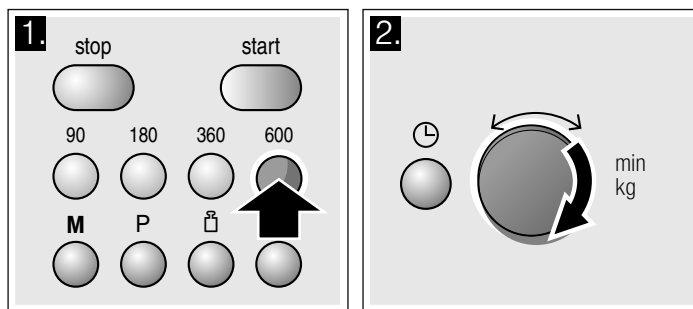

3. 按下启动按键。

烹饪时间在显示屏中倒计时。

烹饪时间到时

一个信号音响起。打开电器门或按下 Stop (停止) 按键。时钟再次出现。

更改烹饪时间

这随时可以进行。使用旋转选择钮更改烹饪时间。

暂停

按一次 Stop (停止) 按钮或打开电器门。在关门后再次按下 Start (启动) 按钮。

取消操作

按两次 Stop (停止) 按钮，或打开电器门并按一次 Stop (停止) 按钮。

提示：还可以先调节烹饪时间，然后设置微波功率。

冷却风扇

本电器装有冷却风扇。即使在微波炉关断后，风扇还会持续运转一段时间。

提示

- 在微波操作过程中，烹饪箱保持冷态。但冷却风扇仍将开启。在微波工作结束时，风机还会持续运转一段时间。
- 门窗、内壁和底板上可能会出现冷凝液。这是正常现象，不影响微波工作。请在烹饪后擦去这些冷凝液。

记忆

您可以将每道菜的设置保存在存储器中，以后可随时重新调用。如果您经常烹制某道菜肴，存储器很有用。

保存存储器设置

实例：360 W，25 分钟

1. 按下 M 按键。
“M” 出现在显示屏中。
2. 按下所需要的微波功率设置。
“M”、所选择的功率设置以及“1:00 min” 出现在显示屏中。
3. 使用旋转选择钮设置烹饪时间。

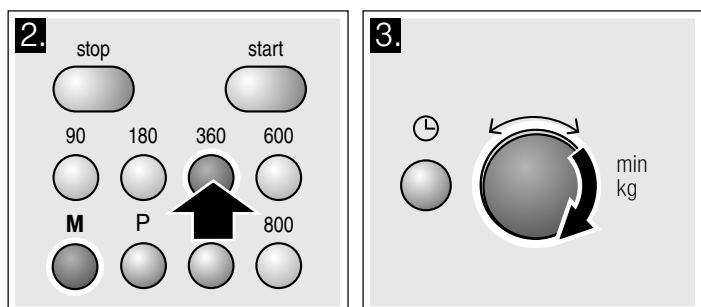

4. 按下 M 按键进行确认。

时钟再次出现。设置被保存。

提示

- 您无法连续保存多个微波功率设置。
- 您无法保存自动程序。
- 您可以保存存储器设置并立即启动电器。完成后，不要按 M，而按下 Start (启动)。
- 将新设置保存到存储器中：按下 M 按键。旧设置出现。按照步骤 1-4 保存新程序。

启动存储器

可轻松启动所保存的程序。将食物放入电器中。关闭电器门。

1. 按下 M 按键。
显示已保存的设置。
2. 按下启动按键。
烹饪时间在显示屏中倒计时。

烹饪时间到时

一个信号音响起。打开电器门或按下 Stop (停止) 按键。时钟再次出现。

暂停

按一次 Stop (停止) 按钮或打开电器门。在关门后再次按下 Start (启动) 按钮。

取消设置

按两次 Stop (停止) 按钮, 或打开电器门并按一次 Stop (停止) 按钮。

保养和清洁

通过小心地保养和清洁您的微波炉, 可以保持其外观和正常工作。以下说明应如何正确保养和清洁电器。

有短路危险!

切勿使用高压清洁剂或蒸汽清洁剂清洁微波炉。

有灼伤危险!

切勿在关断电器后立即清洁电器。

有电击危险!

不要将电器浸入水中进行清洁, 也不要在水枪下进行清洁。

电器的表面材料性质不一, 请遵循下表列出的信息, 以免因使用错误的清洗剂而损坏表面。

不要使用

- 强烈的或腐蚀性的清洁剂。可能会损坏表面。如果此类物质接触到电器正面, 请立即用水清洗掉。
- 勿使用金属或玻璃刮刀清洁电器门上的玻璃。
- 用金属或玻璃刮刀清洁门封。
- 使用粗糙的擦洗片或清洁海绵。新海绵布使用前要彻底清洗。
- 使用含高浓度酒精的清洗剂。

清洁剂

注意!

在清洁之前, 先拔下电器的电源插头或断开保险丝盒中的断路器。用湿布和温和洗涤剂清洁电器外部和烹饪箱。用干净的布擦干。

区域	清洁剂
电器前面板	热肥皂水: 用洗碗布清洁并用软布擦干。请勿使用玻璃清洁剂、金属或玻璃刮刀进行清洁。
不锈钢前面板	热肥皂水: 用洗碗布清洁并用软布擦干。立即清除水垢、油脂、淀粉和蛋白(例如蛋清)形成的斑点。这类残留物可能会引起腐蚀。可向售后服务部或专卖店购买专用不锈钢清洗剂。请勿使用玻璃清洁剂、金属或玻璃刮刀进行清洁。
不锈钢制成的烹饪箱	热肥皂水或醋溶液: 用洗碗布清洁并用软布擦干。 如果微波炉很脏: 请使用烤箱清洁剂, 但只能在烹饪箱冷却后使用。最好使用不锈钢海绵。请勿使用烤箱喷雾剂或其他腐蚀性烤箱清洁剂或磨蚀性材料。擦洗片、粗糙的海绵和平底锅清洗物品均不适用。这些物品会刮伤表面。让内部表面彻底干燥。
烹饪箱中的凹槽	湿布: 切勿让水通过转盘驱动轴渗入电器内部。
转盘和转盘垫圈	热肥皂水: 放回转盘时, 确保其正确卡入。
门面板	玻璃清洁剂: 用洗碗布清洁。不要使用玻璃刮刀。
门封圈	热肥皂水: 用洗碗布清洁, 不要刷洗。不要用金属或玻璃刮刀进行清洁。

故障表

故障通常有简单说明。在给售后服务部打电话前, 请阅读故障表。

如果所烧制的菜肴未达到预期, 请参见“经由我们烹饪工作室测试过的菜谱”, 可在其中看到大量烹饪技巧。

有电击危险!

修理不当是很危险的。只能由我公司派出的经过培训的售后工程师进行修理。

对于某些出错信息, 您可以自己采取补救措施。

故障检修

出错信息	可能的原因	纠正措施 / 说明
电器不工作	电器插头未插入电源插座。	插入插头
	断电	检查厨房灯是否正常。
	断路器故障	查看保险丝盒, 确保电器保险丝正常。
	操作不当	断开保险丝盒中的断路器。约 10 秒后重新连接。
三个零在显示屏中闪烁。	断电	重设时间。
电器不工作。烹饪时间出现在显示屏中。	旋转选择钮被意外按下。	按下 Stop (停止) 按钮。
	在进行设置后没有按下 Start (启动) 按钮。	按下 Start (启动) 按钮, 或按下 Stop (停止) 按钮清除设置。
微波不工作。	门没有完全关闭。	检查是否有剩余食物或异物卡在门内。
	没有按下 Start (启动) 按钮。	按下 Start (启动) 按钮。

出错信息	可能的原因	纠正措施 / 说明
食物加热时间比往常长	微波功率设置太低。 在电器中放置的食物比平常多。 食物比往常要冷。	选择较高的微波功率设置。 双倍的食物量 = 双倍的烹饪时间。 在烹饪过程中搅拌或翻转食物。
转盘发出刮擦声或打磨声。	转盘驱动装置周围区域有灰尘或异物。	清洁烹饪箱中的转盘垫圈和凹槽。
由于不明原因，微波操作已取消。	微波炉发生故障。	如果该故障重复发生，请致电售后服务部。

售后服务

如果您的电器需要修理，我们为您提供售后服务。我们会不断寻找适当的解决方案，避免维修人员不必要的登门造访。

E 编号和 FD 编号

来电时，请提供产品号 (E 编号) 和生产号 (FD 编号)，以便我们为您提供正确的建议。打开电器门时，可以在右侧看到写有这些编号的铭牌。您可以在下面的空白处记下电器编号和售后服务部的电话号码，以便在需要这些号码时不用花时间去找。

E 编号	FD 编号
售后服务 ☎	

请注意，发生故障时，如果电器不在质保期内，维修技师上门会收取费用。

请在随设备提供的客户服务列表中查找所有国家的联系信息。

预约工程师上门及产品咨询

CN 400 889 9999

制造商的专业水平值得您信赖。因此，将由受过专业训练的技术服务人员使用原装电器零件为您维修。

本电器符合标准 EN 55011 和 CISPR 11。它属于分组 2 中的 B 类产品。

分组 2 表示微波炉的生产目的是用于加热食物。B 类表示本电器适合私人家庭使用。

技术参数

输入电压	220 V, 50 Hz
功率消耗	1270 W
最大输出功率	800 W
微波频率	2450 Mhz
保险丝	10 a
尺寸 (高 x 宽 x 深)	
电器	290 x 461 x 351 mm
烹饪箱	194 x 290 x 300 mm
VDE 认证	是
CE 标记	是

环保 处置

以环保方式处置包装材料。



本电器根据有关废弃电气和电子设备 — WEEE 的欧洲指令 2012/19/EG 进行标识。该指令规定了在欧盟范围内有效地回收和再利用旧电器的框架。

自动烹饪程序

使用自动程序可以轻而易举地解冻食物，以及迅速、方便地烹制各色菜式。选择程序，然后输入食物的重量。自动烹饪程序使用最佳设置。有 7 种程序供选。

设置程序

选择程序后，进行如下设置：

1. 反复按下 P 按键，直至出现所需的程序编号。

2. 按下 按键。

“P” 和默认重量出现在显示屏中。

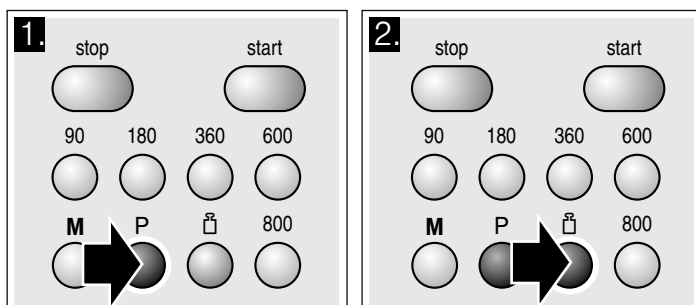

3. 转动旋转选择钮，指定菜肴重量。

4. 按下启动按键。

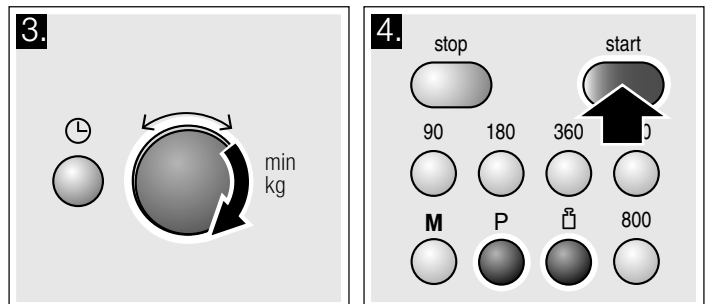

您将看到程序的烹饪时间倒计时。

烹饪时间到时

一个信号音响起。打开电器门或按下 Stop (停止) 按键。时钟再次出现。

更正

按两次 Stop (停止) 按钮，重设。

暂停

按一次 Stop (停止) 按钮或打开电器门。在关门后再次按下 Start (启动) 按钮。

取消

按两次 Stop (停止) 按钮, 或打开电器门并按一次 Stop (停止) 按钮。

提示

- 对于一些程序, 在经过一定时间后会发出一声信号。打开电器门, 搅拌食物或翻转肉类或家禽。在关闭电器门后再次按下 Start (启动) 按钮。
- 可以使用“P”或“”查询程序编号和重量。查询值将在显示屏中显示 3 秒钟。

使用自动程序解冻

您可以使用 4 个解冻程序解冻肉类、家禽和面包。

提示

■ 准备食物

使用在零下 18 °C 下分块冷冻的食物, 越薄越好。将要解冻的食物从包装内取出并称重。您需要了解重量, 以便设置程序。

- 在解冻肉块、家禽时会有汁液产生。在翻转肉和家禽时要将这些汁液倒干净; 禁止将这些汁液用作其它用途或让汁液接触其它食物。

■ 烹饪容器

将食物放在微波炉专用浅盘中, 例如瓷盘或玻璃盘, 但不要盖盖子。

■ 静置时间

解冻后的食物应静置 10 到 30 分钟, 直到温度均匀。大块肉要比小块肉静置更长时间。用肉糜制作的肉块和菜品应分开后再静置。

达到静置时间后, 即便较厚肉块的中心仍未解冻, 也可进一步进行烹制。此时, 可以去除家禽的内脏杂碎。

■ 信号声

对于一些程序, 在经过一定时间后会发出一声信号。打开电器门, 分割食物或翻转肉类或家禽。关闭电器门, 然后按下 Start (启动) 按钮。

程序号		重量范围 (kg)
	解冻	
P 01	肉糜	.20 - 1.00
P 02	肉块	.20 - 1.00
P 03	鸡, 鸡块	.40 - 1.80
P 04	面包	.20 - 1.00

使用自动程序烹饪

您可以使用 3 个烹饪程序来烹饪米饭、土豆或蔬菜。

提示

■ 烹饪容器

食物必须放在带盖的微波器皿中进行烹饪。使用大而深的器皿烹饪米饭。

■ 准备食物

称量食物重量。您需要了解重量, 以便设置程序。

米饭:

不要使用可煮袋装米。按照包装上的说明加入所需水量。水量通常为米量的两到三倍。

土豆:

做水煮土豆时, 将新鲜土豆切成均匀的小块。每 100 g 土豆添加一大汤匙水和少量盐。

新鲜蔬菜:

称量摘净的新鲜蔬菜的重量。将蔬菜切成均匀的小块。每 100 g 蔬菜加入一大汤匙水。

■ 信号声

在程序运行期间, 一段时间后会发出信号。搅拌食物。

■ 静置时间

程序结束后, 再次搅拌食物。应将食物再静置 5 到 10 分钟, 直到温度均匀。

烹饪结果取决于食物的质量和均匀性。

程序号		重量范围 (kg)
	烹饪	
P 05	米饭	.05 - .2
P 06	土豆	.15 - 1.0
P 07	蔬菜	.15 - 1.0

经由 我们烹饪工作室测试过的菜谱

这里提供了各种备选菜谱及其理想设置。我们为您列出了最适合您的菜式的微波功率设置。还有一些关于烹饪容器和制备方法的提示。

参考表格相关说明

下面的表格为您提供各种微波选项和设置。

表格中规定的时间仅作为参考。这些时间可能会随所使用的烹饪容器及食物的质量、温度和均匀性发生变化。

表格中通常规定时间范围。请首先设置最短的时间, 然后根据需要延长延长时间。

实际情况可能是, 您要烹饪的食物量与表格中规定的不同。经验方法:

双倍的食物量 - 几乎双倍的烹饪时间

一半的量 - 一半的烹饪时间。

一定要将烹饪容器放在转盘上。

解冻

提示

- 将敞口容器中的冷冻食品放在转盘上。

- 鸡腿和翅膀等细嫩的部位或烤肉脂肪多的外层可以用小片铝箔包裹。切勿让铝箔接触微波炉内壁。在解冻时间经过一半时, 可以去除铝箔。

- 在解冻肉块、家禽时会有汁液产生。在翻转肉和家禽时要将这些汁液倒干净; 禁止将这些汁液用作其它用途或让汁液接触其它食物。

- 在解冻期间翻转或搅拌食物一次或两次。大块食物应多翻转几次。

- 将解冻过的食物继续在室温下静置 10 到 20 分钟, 令温度均匀。此时, 可以去除家禽的内脏杂碎。即使肉块中心仍有少部分未解冻, 仍可进一步烹饪。

解冻	重量	微波功率设置 (W), 烹饪时间 (分钟)	注意
整块肉 (带骨或去骨的牛肉、小牛肉或猪肉)	800 g	180 W, 15 分钟 + 90 W, 10-20 分钟	-
	1 kg	180 W, 20 分钟 + 90 W, 15-25 分钟	
	1.5 kg	180 W, 30 分钟 + 90 W, 20-30 分钟	

解冻	重量	微波功率设置 (W), 烹饪时间 (分钟)	注意
肉块或肉片 (牛肉、小牛肉或猪肉)	200 g	180 W, 2 分钟 + 90 W, 4-6 分钟	翻转时将已解冻的部分分开
	500 g	180 W, 5 分钟 + 90 W, 5-10 分钟	
	800 g	180 W, 8 分钟 + 90 W, 10-15 分钟	
五花肉糜	200 g	90 W, 10 分钟	尽量平放冷冻食品 翻转数次, 取出所有解冻的菜肴
	500 g	180 W, 5 分钟 + 90 W, 10-15 分钟	
	800 g	180 W, 8 分钟 + 90 W, 10-20 分钟	
家禽或家禽块	600 g	180 W, 8 分钟 + 90 W, 10-15 分钟	-
	1.2 kg	180 W, 15 分钟 + 90 W, 20-25 分钟	
鱼块、鱼排或鱼片	400 g	180 W, 5 分钟 + 90 W, 10-15 分钟	将已解冻的部分分开
蔬菜, 例如豌豆	300 g	180 W, 10-15 分钟	-
水果, 例如覆盆子	300 g	180 W, 7-10 分钟	在解冻期间小心地搅拌, 将已解冻的部分分开
	500 g	180 W, 8 分钟 + 90 W, 5-10 分钟	
黄油, 解冻	125 g	180 W, 1 分钟 + 90 W, 2-3 分钟	去除所有包装
	250 g	180 W, 1 分钟 + 90 W, 3-4 分钟	
条形面包	500 g	180 W, 6 分钟 + 90 W, 5-10 分钟	-
	1 kg	180 W, 12 分钟 + 90 W, 10-20 分钟	
干蛋糕, 例如海绵蛋糕	500 g	90 W, 10-15 分钟	仅用于不加糖衣、奶油或奶黄酱的蛋糕, 分离蛋糕块
	750 g	180 W, 5 分钟 + 90 W, 10-15 分钟	
湿蛋糕, 例如水果馅饼、干酪蛋糕	500 g	180 W, 5 分钟 + 90 W, 15-20 分钟	仅适用于不加糖衣、奶油或白明胶的蛋糕
	750 g	180 W, 7 分钟 + 90 W, 15-20 分钟	

解冻、加热或烹饪冷冻食品

提示

- 将熟食从包装内取出。放入可以微波加热的烹饪容器, 加热过程会更快、更均匀。菜肴中的不同成分所需要的加热时间可能不一样。
- 平摊食物的烹饪速度比堆放食物的烹饪速度快得多。因此, 应摊开食物, 使其在烹饪容器内尽量摊平。不应将不同食物相互叠放在一起。

- 一定要盖上食物。如果烹饪容器没有合适的盖子, 则用盘子或专用微波薄膜盖上。
- 烹饪期间应搅拌或翻转食物 2 到 3 次。
- 在加热后, 继续让食物保留 2 到 5 分钟, 以便温度均匀。
- 当从微波炉中取出盘子时, 一定要使用烤箱布或烤箱手套。
- 这样做有助于食物保持自己独特的味道, 食物需要更少的调味品。

解冻、加热或烹饪冷冻食品	重量	微波功率设置 (W), 烹饪时间 (分钟)	注意
套餐、点餐、即食餐 (2-3 个元器件)	300-400 g	600 W, 8-11 分钟	-
汤	400 g	600 W, 8-10 分钟	-
炖肉	500 g	600 W, 10-13 分钟	-
带调味料的肉条或肉片, 例如菜炖牛肉	500 g	600 W, 12-17 分钟	搅拌时将肉块分开
鱼, 如鱼排	400 g	600 W, 10-15 分钟	根据需要加入水、柠檬汁或酒
烘焙, 例如意式烤宽面和意式烤碎肉卷	450 g	600 W, 10-15 分钟	-
配菜, 例如米饭、意大利面	250 g	600 W, 2-5 分钟	加一些汁液
	500 g	600 W, 8-10 分钟	
蔬菜, 如豌豆、椰菜、胡萝卜	300 g	600 W, 8-10 分钟	向盘子里倒水, 使水淹没盘底
	600 g	600 W, 14-17 分钟	
菠菜奶油沙司	450 g	600 W, 11-16 分钟	烹饪时不另外加水

加热食物

⚠ 有烫伤危险!

加热的液体有可能延时沸腾。即液体达到沸腾温度后, 却没有常见的蒸汽气泡冒上液面。即使容器只是稍微振动, 滚烫的液体也会突然沸腾溢出和飞溅。在加热液体时, 一定要在容器内放一把汤匙。这会防止延时沸腾。

注意!

金属 (例如玻璃杯内的汤匙) 必须距离烹饪箱内壁和门内壁至少 2 cm。否则, 火花会损坏门内壁的玻璃。

提示

- 将熟食从包装内取出。放入可以微波加热的烹饪容器, 加热过程会更快、更均匀。菜肴中的不同成分所需要的加热时间可能不一样。
- 一定要盖上食物。如果容器没有合适的盖子, 请用盘子或专用微波薄膜盖上。
- 在加热期间搅拌或翻转食物几次。检查温度。
- 在加热后, 继续让食物保留 2 到 5 分钟, 以便温度均匀。
- 当从微波炉中取出盘子时, 一定要使用烤箱布或烤箱手套。

加热食物	重量	微波功率设置 (W), 烹饪时间 (分钟)	注意
套餐、点餐、即食餐 (2-3 个元器件)	350-500 g	600 W, 4-8 分钟	-
饮品	150 mL	800 W, 1-2 分钟	将汤匙放入玻璃容器中; 不要让酒类饮品过热; 在加热期间检查
	300 ml	800 W, 2-3 分钟	
	500 ml	800 W, 3-4 分钟	
婴儿食品, 如奶瓶	50 ml	360 W, 约 1/2 分钟	没有盖子。加热后要摇匀。必须检查温度。
	100 ml	360 W, 约 1 分钟	
	200 ml	360 W, 1 1/2 分钟	
汤, 1 杯	200 g	600 W, 2-3 分钟	-
汤, 2 杯	400 g	600 W, 4-5 分钟	-
带酱汁的肉	500 g	600 W, 8-11 分钟	分开肉块
炖肉	400 g	600 W, 6-8 分钟	-
	800 g	600 W, 8-11 分钟	-
蔬菜, 1 份	150 g	600 W, 2-3 分钟	加一些汁液
蔬菜, 2 份	300 g	600 W, 3-5 分钟	

烹饪食物

提示

■ 平摊食物的烹饪速度比堆放食物的烹饪速度快得多。因此, 应摊开食物, 使其在烹饪容器内尽量摊平。不应将不同食物相互叠放在一起。

- 在盖上盖子的容器中烹饪食物。如果烹饪容器没有合适的盖子, 请用盘子或专用微波薄膜盖上。
- 这样做有助于食物保持自己独特的味道, 食物需要更少的调味品。
- 烹饪后, 让食物静置 2-5 分钟, 以便温度均匀。
- 当从微波炉中取出盘子时, 一定要使用烤箱布或烤箱手套。

烹饪食物	重量	微波功率设置 (W), 烹饪时间 (分钟)	注意
肉饼	750 g	600 W, 20-25 分钟	烹饪时不盖盖子
去掉内脏杂碎的新鲜整鸡	1.2 kg	600 W, 25-30 分钟	在烹饪中途翻转
新鲜蔬菜	250 g	600 W, 5-10 分钟	将蔬菜切成大小均匀的小块。每 100 g 蔬菜中加入 1 到 2 汤匙水。在烹饪过程中搅拌
	500 g	600 W, 10-15 分钟	
土豆	250 g	600 W, 8-10 分钟	将土豆切成大小均匀的小块。每 100 g 加入 1 到 2 汤匙水。在烹饪过程中搅拌
	500 g	600 W, 11-14 分钟	
	750 g	600 W, 15-22 分钟	
米饭	125 g	800 W, 5-7 分钟 + 180 W, 12-15 分钟	加入双倍的汁液。
	250 g	800 W, 6-8 分钟 + 180 W, 15-18 分钟	
甜食, 如牛奶冻 (即食)	500 ml	600 W, 6-8 分钟	在烹饪过程中用搅蛋器彻底搅拌奶油蛋羹两到三次。
水果, 蜜饯	500 g	600 W, 9-12 分钟	-

微波使用技巧

您无法找到准备烹饪的食物量的相应设置信息。

依据下面的经验, 酌情增加或减少烹饪时间:

双倍的食物量 = 几乎双倍的烹饪时间

一半的量 = 一半的烹饪时间

食物变得太干。

下一次, 缩短烹饪时间或选择较低的微波功率设置。给食物盖上盖子, 并加入更多的汁液。

在到达时间后, 食物没解冻、没热或没熟。

设置更长的时间。量大、堆放的食物需要更长的时间。

在到达时间后, 食物的边缘过热, 但中部没熟。

在烹饪过程中搅拌, 下次选择一个较低的微波功率设置和较长的烹饪时间。

在解冻之后, 家禽或肉外部已解冻, 但中部没解冻。

下一次, 选择一个较低的微波功率设置。如果需要解冻的食物量大, 要翻转几次。

冷凝

门窗、内壁和底板上可能会出现冷凝液。这是正常现象。不会影响微波的作用。请在烹饪后擦去这些冷凝液。

符合 EN 60705 标准的测试菜谱

测试协会使用下列菜式对微波炉的质量和功能进行测试。

按照 EN 60705、IEC 60705、DIN 44547 和 EN 60350 (2009)

用微波烹饪和解冻

微波烹饪

餐点	微波功率设置 (W) 和烹饪时间 (分钟)	注意
奶油蛋羹, 565 g	180 W, 25-30 分钟 +90 W, 20-25 分钟	将 20 x 17 cm 耐热玻璃器皿放在转盘上。
海绵蛋糕	600 W, 8 - 10 分钟	将直径为 22 cm 耐热玻璃器皿放在转盘上。
肉卷	600 W, 20 - 25 分钟	将耐热玻璃餐盘放在转盘上。

微波解冻

餐点	微波功率设置 (W) 和烹饪时间 (分钟)	说明
肉	180 W, 5-7 分钟 + 90 W, 10-15 分钟	将直径为 22 cm 耐热玻璃器皿放在转盘上。

产品中有害物质的名称及含量

部件名称	有害物质					
	铅 (Pb)	汞 (Hg)	镉 (Cd)	六价铬 (Cr(VI))	多溴联苯 (PBB)	多溴二苯醚 (PBDE)
印制电路组件	×	○	○	○	○	○
显示单元	×	○	○	○	○	○
电源线及连接线	×	○	○	○	○	○
电机、驱动部件及风扇	×	○	○	○	○	○
外壳组件	×	○	○	○	○	○
隔热组件	○	○	○	○	○	○
加热腔体组件	×	○	○	○	○	○
照明组件	×	○	○	○	○	○
门体组件	×	○	○	○	○	○
微波发生部件	○	○	○	○	○	○

本表格依据SJ/T 11364 的规定编制。

○：表示该有害物质在该部件所有均质材料中的含量均在 GB/T 26572 规定的限量要求以下。

×：表示该有害物质至少在该部件的某一均质材料中的含量超出GB/T 26572 规定的限量要求。

注意：上表包含了本公司生产的此类产品的全部部件，本产品的部件以实际配置为准。

如您对此有任何疑问，请拨打本产品所提供的公司客服电话。

产品环保信息提示性说明

请按照产品说明书的要求使用和维护本产品，不当利用或者处置本产品可能会对环境和人类健康造成影响。

依照国家《废弃电器电子产品回收处理条例》的有关规定，当您计划将此产品废弃时，请将其交给具有废弃电器电子产品处理资格的处理企业进行处理。产品中有毒有害物质含量信息参照上表。



BSH Hausgeräte GmbH
Carl-Wery-Straße 34
81739 München
GERMANY

Manufactured by BSH Hausgeräte GmbH under Trademark License of Siemens AG
由 BSH 家用电器有限公司根据西门子股份公司的商标许可制造



9000695703 (05) 961123