

SIEMENS

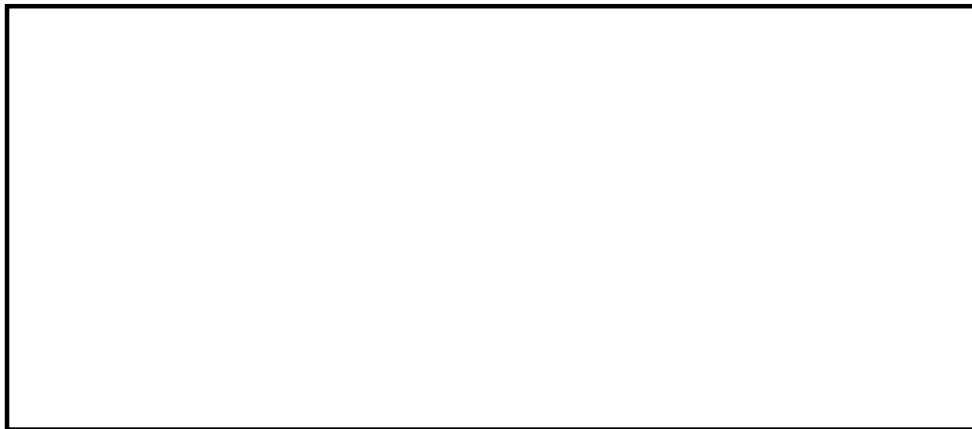

USER INSTRUCTIONS

INSTALLATION INSTRUCTIONS

MAINTENANCE INSTRUCTIONS

This cooktop is for use with Natural Gas and Universal LPG

Leave these instructions with the owner

EC945RB90A

Siemens - Electrogeräte GmbH
Carl-Wery-Straße 34
81739 München

SIEMENS

Cod. 9000271008 C



GMK10045

Dear customer,

We would like to thank and congratulate you for your choice. This practical modern appliance has been made using materials of the highest quality, which have been put through the strictest of Quality Controls during manufacture and meticulously tested to ensure that they meet all of your cooking demands. We kindly ask you to read and follow these simple instructions in order to guarantee first-class results from the very start. This booklet contains important information not only concerning use, but also concerning your own personal safety and maintenance of the appliance.

Our products need to be carefully packed to protect them during transportation. All the material used for packing is considered essential for this purpose and is also completely recyclable. You too can contribute towards protecting the environment by disposing of this material at your nearest recyclable refuse collection point. Do not dispose of used cooking oil down the kitchen sink. Oil may seriously damage the environment. Dispose of it in a closed container at your nearest collection point or, failing this, dispose of it in your rubbish bin. Although this last solution is far from perfect, your oil will be taken to a controlled refuse dump where it will not be allowed to pollute water. You and your children will appreciate it. Render your old appliance useless before disposing of it at your nearest recyclable refuse collection centre. Your local authority will be pleased to inform you where your nearest centre is.

CONTENT

Safety considerations	4
For your safety	4
What to do if yo smell gas	4
Warnings	4
Installation	6
Preparing to install	6
Clearances	7
Installation of cooktop into Kitchen bench	7
Installation procedure	8
Connection	9
Electrical connection	9
Gas connection	10
Conversion front Nat. Gas to Universal LPG.....	11
To change injectors	11
Injector size chart	12
Minimum flame adjustment	12
Operating instructions	13
Burner location	13
Burner ignition & control	13
Wok burner operation	14
User instructions	16
Warnings concerning cooking	17
Cleaning and maintenance	18
Service	19
Trouble shooting	19
Wiring diagram	20

Wiring diagram

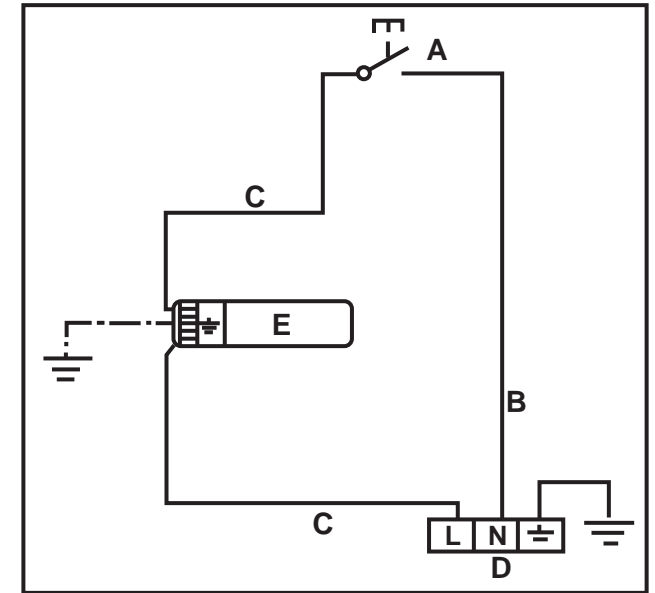

- A. Switch
- B. Blue wire
- C. Brown wire
- D. Terminal
- E. Ignition module

www.siemens-home.com CIF: A-28-893550		
Siemens-Electrogeräte GmbH		
E-Nr EC945RB90A		FD
Gas type	NG	ULPG
Test point pressure (kPa)	1,0	2,75
Injectors marks:		
LHF	155	85
LHR	90	50
RHF	118	67
RHR	118	67
Centre	85/110	43/68
HGC (MJ)	44,10	40,00
In compliance with AS/NZS 3100 and AS 4551:2008		
Preinstalled NG		 GMK10045
MADE IN SPAIN		
Distributed by BSH Home Appliances Pty Ltd		

Trouble shooting chart

It is not always necessary to call the Service Centre. In some cases, you may be able to solve the problem yourself. This table contains some useful information.

Important:

Only authorised personnel from the Service Centre are qualified to work on the main gas and electric systems.

What's wrong	Possible cause	Solution
...If none of the electrical systems work?	<ul style="list-style-type: none"> • Power turned off. • Faulty fuse. • The automatic circuit breaker or mains differential has been triggered. 	<ul style="list-style-type: none"> • Turn power on. • Check the fuse in the main fuse box and replace if faulty. • Check to see if the circuit breaker or a differential has been triggered in the mains supply box.
...If the electronic ignition system does not work?	<ul style="list-style-type: none"> • There may be food or cleaning product particles between the spark plugs and the burners. • The burners are wet. • The burner covers are not positioned correctly. 	<ul style="list-style-type: none"> • The gap between the spark plug and the burner needs to be cleaned carefully. • Dry the burner covers carefully. • Make sure that the burner covers are correctly positioned.
...If the flame on the burners is not evenly distributed?	<ul style="list-style-type: none"> • The burner components have not been assembled properly. • The gas ports on the burners are dirty. • The burners may not be totally dry. 	<ul style="list-style-type: none"> • Put the components in their correct positions. • Clean the gas ports on the burners. • Dry the burners more thoroughly (be particularly careful with single-piece burners).
...If the gas flow does not seem normal or there is no gas flow at all?	<ul style="list-style-type: none"> • The isolation valve is closed. • If the gas is supplied from a gas bottle, it may be empty. 	<ul style="list-style-type: none"> • Open the isolation valve. • Replace the gas bottle with a full one.
...If the kitchen smells of gas?	<ul style="list-style-type: none"> • One of the valves has been left open. • Possible leak on the gas bottle coupling. 	<ul style="list-style-type: none"> • Check to see if a valve has been left open. • Check that the coupling on the gas bottle is in order.
...If the safety cut-off devices on the different burners do not work?	<ul style="list-style-type: none"> • The control knob has not been kept pressed in for long enough. • The burner ports are dirty. 	<ul style="list-style-type: none"> • Once ignited, keep the control pressed in for a few seconds. • Clean the burner ports.

Any of the following are considered to be abnormal operation and may require servicing:

Yellow tipping of the hob burner flame.

Sooting up of cooking utensils.

Burners not lighting properly.

Burners failing to remain alight.

Gas valves, which are difficult to turn in case the appliance fails to operate correctly, contact the authorised service provider in your area.

Safety considerations

For your safety

- If the information in this manual is not followed exactly, a fire or explosion may result causing property damage, personal injury or death.
- Do not store articles on or against this appliance.
- Do not store flammable material near this appliance.
- Do not spray aerosols in the vicinity of this appliance while it is in operation.
- Do not try to light the appliance.
- Do not touch any electrical switch; do not use any phone in your building.
- Immediately call your gas supplier from a neighbour's phone. Follow the gas supplier's instructions.
- If you cannot reach your gas supplier, call the fire department.
- Installation and service must be performed by an authorised person.

What to do if you smell gas

Warnings

DO NOT MODIFY THIS APPLIANCE.

1. Do not allow the flame to extend beyond the edge of the cooking utensil. This instruction is based on safety considerations.
2. Do not forget that the unit becomes hot when in use. Common sense is important. Just because the flame is out, does not mean parts cannot still be hot.
3. This appliance shall not be used for space heating. This instruction is based on safety considerations.
4. Be sure to disconnect the electrical supply before disassembly of the appliance.
5. Keep the appliance area clear and free from combustible materials, gasoline and other flammable vapours and liquids.
6. This appliance must be installed in a position with the proper level of ventilation. Do not obstruct the flow of combustion and ventilation air.
7. Cabinets installed above the gas cooktop must have a minimum clearance of 650 mm (24").
8. The gas pressure regulator supplied with the appliance must be installed in line with the gas pipe. (N.G. only)
9. For pressure testing in excess of 3.5 kPa (1/2 psig) the appliance and its individual shutoff valve must be disconnected from the gas supply piping system.
10. Important. When using a very large pot, leave a gap of at least 50 mm (2") to avoid damaging any parts in bench top wood, plastic or other non-heat resistant materials. Never leave oil or hot fat unattended.
11. The surfaces on heating and cooking appliances get hot when in use. Be careful. **Keep children away from the appliance.**

12. Only use your appliance for the preparation of food and **never** for room-heating purposes.

13. This appliance leaves the factory set for the gas supply indicated on the data plate. **Call the Service Centre** if it needs to be altered.

14. Do not tamper inside the appliance. If necessary, call your local **Service Centre**.

15. Overheated fat or oil can easily catch fire. Never leave the appliance unattended when cooking food with fat or oil, e.g. chips.

16. Never pour water on burning fat or oil. **DANGER OF BURNS!** Cover the receptacle to smother the flames and turn the hob off.

17. In the event of a fault, cut the gas and electricity supplies to the appliance. Call our **Service Centre** to repair the fault.

18. Do not use unstable or uneven-based receptacles on cooking plates or burners. They may accidentally tip over.

19. If a gas supply knob/valve jams, do not force it. Call your official Service Centre immediately for them to repair or replace it.

20. The illustrations used in this booklet are only intended as a guide.

21. If your hob is supplied with a glass cover, do not subject it to excessive force. If the glass should become detached from the hob, **call the Service Centre immediately** for them to repair or replace it.

22. While using your gas should avoid draughts and spillages of cold liquids. As these may cause the glass to break.

23. Grids become very hot during use. When operating the appliance control knobs, take care not to make contact with the grids.

24. Do not use this appliance neither in marine craft nor in caravans.

25. This appliance is only intended for cooking purposes, not as a heating system.

This appliance is not intended for use by persons (including children) with reduced physical, sensory or mental capabilities, or lack of experience and knowledge, unless they have been given supervision or instruction concerning use of the appliance by a person responsible for their safety.

Make sure you keep these instructions for use and assembly in a safe place, so that you can hand them on with the appliance if it ever changes owner.

Note: To avoid jeopardising the electrical safety of the appliance, it is forbidden to use high-pressure or steam jet cleaning devices.

SHOULD THE RELEVANT CONDITIONS NOT BE PROPERLY SATISFIED, THE INSTALLER, AND NOT THE MANUFACTURER, SHALL BE HELD LIABLE.

Cleaning and maintenance:

DON'Ts

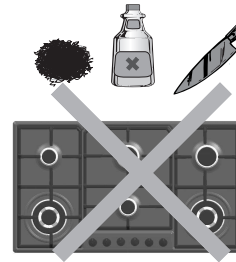

Do not use scouring powder, over cleaner sprays or abrasive pads that may scratch the glass. Never use sharp objects such as knives or wire wool to remove the remains of food that has become encrusted onto the surface. Do not use knives, scrapers or similar implements for cleaning the joins with the metal.

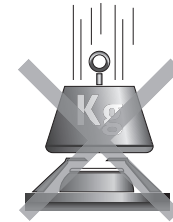

Do not slide recipients over the glass as they may scratch it. Similarly, do not drop hard or sharp objects onto the glass. Avoid Knocking any part of the edge of the cooking plate.

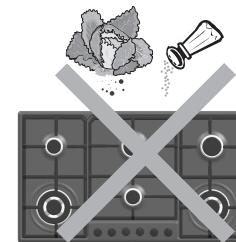

Grains of sand, which may, for example, come from cleaning vegetables, can scratch the glass surface.

DOs

Once the appliance is cold, clean it with a **sponge and soapy water**.

Clean the surface of the heating elements once they have cooled down, each time they are used. Even small amounts of dirt burn when it is switched on again.

The burners and pans support must be cleaned regularly to keep them clean. This is done by submerging them in soapy water and scrubbing them with a non-metal brush to keep the holes and slits free from obstruction so they can give a perfect flame. Dry the burner covers whenever wet or damp.

After cleaning and drying the burners, make sure that the covers are properly in position on the flame diffuser.

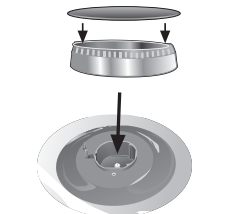
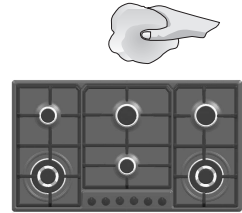

The high temperatures suffered by the cover on the triple-flame burner ring and the stainless steel parts on your hob (plate rings, grease trays, area around burners, etc) may become discoloured over time. This is **NORMAL**. Clean them after use with a product suitable for stainless steel.

After washing the pans support, dry them thoroughly before cooking with them again. The presence of droplets of water or dampness at the beginning of the cooking process may damage the enamel surface.

Be careful with the feet on the metal grids when cleaning them; if they are detached, the grid may scratch the glass next time it is used.

Warnings concerning cooking:

DON'Ts

DOs



Do not use small receptacles on large burners. The flame should not touch the sides of receptacles.

Always use suitably sized receptacles on each burner. This helps avoid excessive gas consumption and prevents receptacles from getting tarnished.

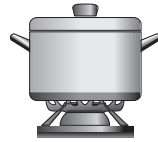

Do not cook without lids or with lids only partially covering receptacles. You are wasting energy.

Always use **lids**.

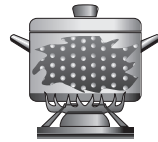

Do not use receptacles with uneven bases. They lengthen cooking times and increase energy consumption.

Only use thick, flat-based saucepans, **frying pans and casseroles**.

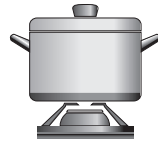

Always place receptacles **in the middle** of burners.



Do not place receptacles on burners off centre. They could tip over.

Always place receptacle **on the pans support**. Make sure that the metal grids and the tops of the burners are correctly positioned before using them.

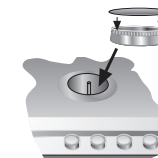

Do not use wide-based receptacles on the burners nearest to the controls. When centred on the burner, they could touch the controls or raise the temperature in the area. This may damage the hob.



Do not place receptacles directly on top of burners.

Handle receptacles on the hob with **care**.

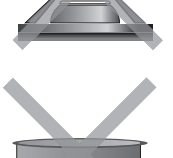
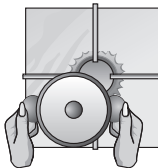

Do not use two burners or heat sources for a single recipient.

Only use one recipient per burner. Use the extra metal grid on the wok burner.

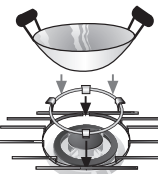

Do not use baking trays, earthenware dishes, etc... at full heat for a long time.

Installation

Statutory requirements

This installation must conform with the following:

- Manufacturer's Installation instructions
- Local Gas Fitting Regulations
- Municipal Building Codes,
- Installation Code for Gas Burning Appliances. (AS/NZS 5601.1)

Preparing to install

- S.A.A. Wiring Code
- Local Electrical Regulations
- Any other statutory regulations

Refer to the AS/NZS 5601.1 for piping size details. These built-in hobs are intended to be inserted in a benchtop cutout.

Only an officially authorised technician should connect the appliance.

Before you begin, turn off the gas and electricity supply.

Installation dimensions are shown in Fig.1-1a.

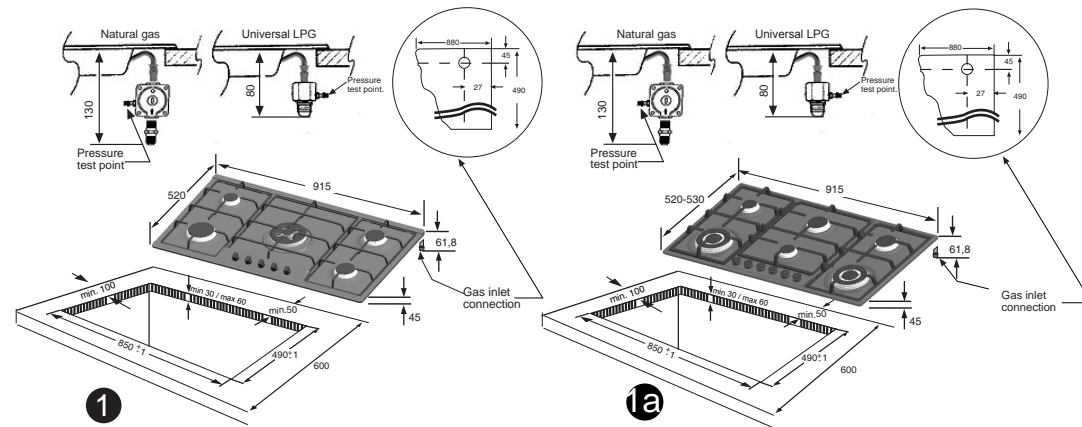

Before connecting the unit, check whether the local connection conditions (type of gas) are compatible with the unit's setting. Observe any special conditions imposed by local suppliers (utilities). The specifications of this cooktop are stated on the data label located on the bottom of the cooktop base.

A duplicate data label is supplied for adhesion to an accessible location near the hotplate if the data label on the base of the hotplate cannot be accessed when the hotplate is installed.

Clearances

A range hood fitted above the top must be installed according to the installation instructions for the range hood. A minimum distance of 650 mm is required for a range hood and 750 mm for an exhaust fan.

Any adjoining wall surface situated within 200mm from the edge of any hob burner must be a suitable non-combustible material for a height of 150mm for the entire length of the hob. Any combustible construction above the hotplate must be at least 650mm above the top of the burner and no construction shall be within 450mm above the top of the burner.

A minimum depth of 50mm from the top of the worktop surface must be provided for the appliance.

If the base of the hotplate can be touched, a protecting shield must be fitted. This shield must be at least 10mm from the lowest part of the hotplate and must be capable of withstanding the appliance temperatures.

Minimum thickness of benchtop is 30 mm. See Fig. 2.

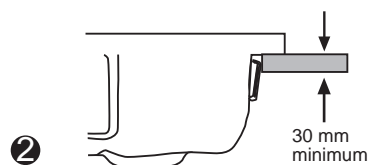

Installation of cooktop into the kitchen bench

Installation procedure:

Side clearances: If the distance measured from the periphery of the nearest burner to any vertical surface is less than 200 mm, the surface shall be protected in accordance with clauses 6.10.1.1 & 6.10.1.2 of AS/NZS 5601.1.

1. For cutout dimensions and clearances refer Fig.1-1a

2. a) If the clamps and the selfadhesive seal (lower edge of the hob) are already fitted (depending on the model), do not under any circumstance remove them. The seal keeps the entire work surface watertight and prevents spillage from leaking into cupboards underneath. Slightly loosen the retaining screws of the clamps positioned at the bottom of the cooktop.

b) If the clamps and the selfadhesive seal have not been fitted in the factory, remove the pan support and the gas burner covers from your cooking hob and turn it upside down. Now fit the selfadhesive seal supplied with the appliance onto the lower edge of the hob. Take the clamps and screw them into the lower point designed for this purpose. See Fig. 3.

Cooking recommendations

	Very high /High	Medium	Low
Wok burner	Boiling, grilling, browning, and Asian food (wok).	Reheating and keeping things hot, cooked and pre-cooked dishes.	
Large burner	Steaks, omelettes, frying.	Rice, white sauce and ragout.	Steaming, and vegetables.
Medium burner	Steaming potatoes, fresh vegetables, stews and pasta.	Reheating, keeping things hot and making tasty casseroles.	
Small burner	Casseroles, rice pudding and caramels.	Defrosting and slow cooking: vegetables fruits and frozen products.	Melting: butter, chocolate and jelly.

User Instructions

Boiling burners

Use “High flame” setting to bring the pan to the boil, then adjust the flame between “High flame” and “Low flame” to maintain the required pan temperature. Important:

The use of a cooktop leads to the production of heat and moisture in the kitchen. For this reason make sure that the room is properly ventilated. Keep natural ventilation openings, such as windows, open or provide a mechanical ventilation device (e.g. a range hood or overhead exhaust fan). An orangy flame is normal and simply indicates the presence of salt in the atmosphere (from cooking). If the flame has yellow patches, this is not a fault (of any kind).

For safety and economic gas usage you should always use the correct pan on the correct burner. Flames should not protrude beyond the base of the pan. You will save energy, time and money by always placing the correct pan size on the correct gas ring. See fig. 14.



The chart below gives the correct pan usage for each burner

Burner	Recomended pan diameter	Minimum pan diameter
Small burner	120-140 mm.	120 mm.
Medium burner	140-200 mm.	140 mm.
Large burner	220-260 mm.	220 mm.
Wok burners	≥ 220 mm.	
Big wok burners	≥ 220 mm.	

Wok trivet

Depending on the model, the hotplate is supplied with an extra wok trivet. This trivet must be used when using the wok burner for receptacles with diameters of more than 26 cm diameter, griddle plates and all kinds of concave receptacles such as woks, etc.

The manufacturer cannot be held responsible for the non-use or misuse of this additional pan support.

Coffee support

Depending on the model, the hotplate is supplied with an extra coffee support. This support is for use only with the small burner when supporting receptacles with a diameter of less than 10 cm.

The manufacturer cannot be held responsible for the non-use or misuse of these additional pan supports.

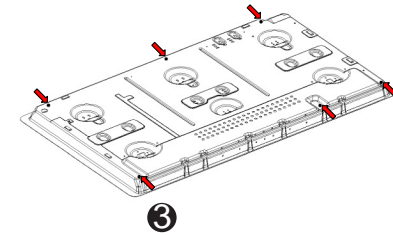

3. Place the hotplate on top of the bench cut-out and press down firmly on all edges at the same time to ensure that the hob is resting on its entire perimeter.

4. Once the hob is fitted you should turn the clips and tighten the screw as shown in Fig. 4.

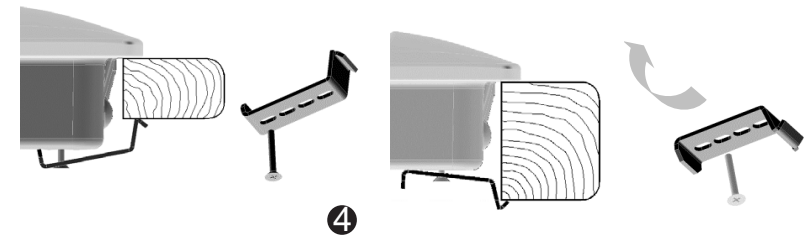

Connection

Electrical:

An electrical 10 amp socket needs to be within 1 m of the hotplate to allow electrical connection. The socket must remain accessible after installation of the appliance.

Important note:

This appliance is connected to the mains (240 VAC) by means of the connecting lead which must be fixed to the kitchen unit to prevent it from coming into contact with hot parts of the hob (or an oven installed underneath) and remain accessible after installation of the cooktop. When making this connection make sure that the lead cannot come into contact with hot parts of the hob.

Important: This appliance must be earthed. When connecting the cooktop ensure that the earth wire is connected first and that all wires are connected to the correct terminals.

Gas:

During the planning stage, consider the position of supply connections.

The hob must be connected to the gas supply with upstream connection of an isolation valve in accordance with the respectively valid regulations. We recommend that the isolation valve be fitted prior to the cooktop to enable isolation of cooktop from gas supply. The valve must be easily accessible at all times.

To find out the factory set gas type, see bottom of cooktop next to gas connection.

Remove plastic cap from gas supply line prior to installation.

Fit regulator (N.G.) or a test point (Universal LPG) directly to the R^{1/2}" connection as per Fig. 5. and Fig. 6.

Direction of gas flow is indicated on the rear of the regulator. For position of the inlet connection refer Fig.1-1a. Use pipe compound or thread sealant, properly threaded pipes and careful assembly procedure so that there is no cross threading, etc., which might cause damage or leakage. Make sure that all connections performed are free of leakage. The manufacture does not accept any liability for leakage on connections performed by the installer or if the L-tube is moved or twisted.

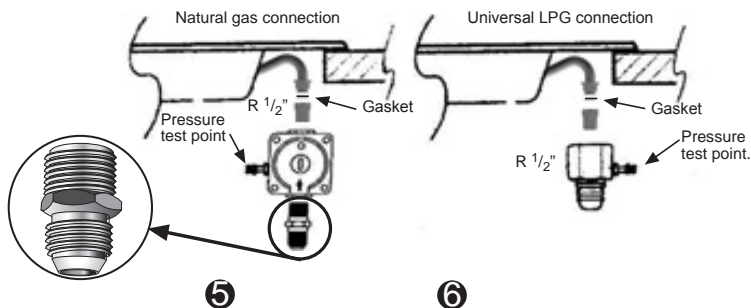

Wok burner operation

The wok control has 4 settings.

Largest flame = The outer and inner burners are both operating on high flame.

Large flame = The outer burner burns low and the inner burner burns high.

Small flame = Only the inner burner burns high.

Smallest flame = Only the inner burner burns low.

For ongoing cooking a variable setting between the flame sizes can be used.

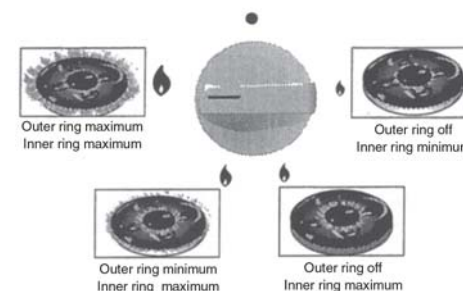

Operating instructions

Burner locations

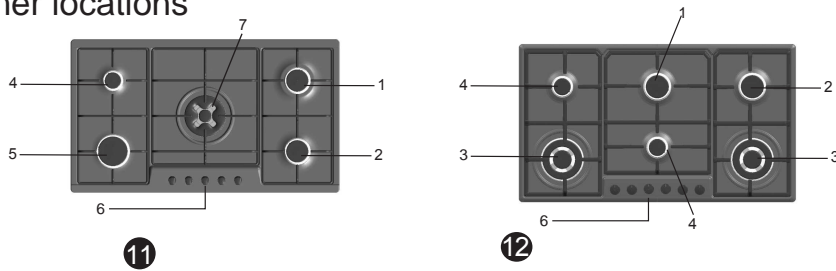

- | | |
|------------------|-------------------|
| 1. Medium burner | 4. Small burner |
| 2. Medium burner | 5. Rapid burner |
| 3. Wok burner | 6. Control Knobs |
| | 7. Big wok burner |

Burner ignition & control

Depress control knob and turn anti-clockwise to "High flame" position. Hold the knob down for a few seconds until the flame ignites. Keep control knob depressed for a few seconds to activate the flame failure device. If ignition fails, depress knob again and wait for ignition. Turn anti-clockwise to set the flame to the desired intensity.

If ignition fails depress knob and try again. If flame is not established in 15 seconds release the control knob and open a door and wait 1 minute before attempting a new ignition procedure.

All burners are fitted with a flame failure device which shuts off the gas supply if the flame extinguishes for any reason. To re-ignite, wait 30 seconds for any unburnt gas to disperse before repeating the ignition procedure described above.

To turn off the gas supply to a burner turn the control knob clockwise to the "OFF" position. (Refer Fig. 13)

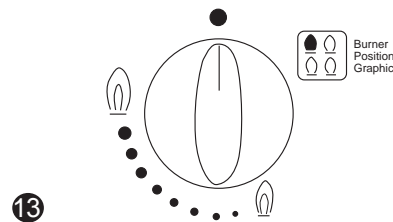

The control knob is used to adjust the flame of the gas burner.

"Low flame" graphic= lowest output

"High flame" graphic= highest output

If the ignition sparkers are dirty, this makes the burners harder to light, so you should keep them as clean as possible. Clean them using a small brush and remember that the ignition sparkers must be treated very gently.

There are two ways to carry out the connection to the main gas line:

A. The hotplate can be connected with rigid pipe as specified in AS/NZS 5601.1.

B. Flexible Hose: If installing with a hose assembly, install with a hose assembly that complies with AS/NZS 1869 (AGA Approved), 10mm ID, class Bor D, no more than 1,2m long and in accordance with AS/NZS 5601.1. Ensure that the hose does not contact the hot surfaces of the hotplate, oven, dishwasher or any other appliance that may be installed underneath or next to the hotplate. The hose should not be subjected to abrasion, kinking or permanent deformation and should be able to be inspected along its entire length with the cooktop in the installed position.

Unions compatible with the hose fittings must be used and all connections tested for gas leaks.

The supply connection point shall be accessible with the appliance installed.

WARNING: Ensure that the hose assembly is restrained from accidental contact with the flue outlet of an under-bench oven.

Before Leaving- Check all connections for gas leaks with soap and water. DO NOT use a naked flame for detecting leaks. Ignite all burners both individually and concurrently to ensure correct operation of gas valves, burners and ignition. Turn gas taps to low flame position and observe stability of the flame for each burner individually and all together. Adhere the duplicate data plate to an accessible location near the hotplate. When satisfied with the hotplate, please instruct the user on the correct method of operation. In case the appliance fails to operate correctly after all checks have been carried out, refer to the authorised service provider in your area.

It should be expressly noted that we cannot accept any liability for direct or indirect damage caused by wrong connection, leakage or improper installation. When being repaired, the appliance must always be disconnected from the mains supply; if required, notify our customer service.

Coverting the cooktop from Nat.Gas to Universal LPG

To change injectors

All work involved in installation, setting and adaptation to a different gas type must be carried out by authorised personnel from our Service Centre and must comply with current regulations and the conditions laid down by the local gas company.

Request change-over injectors from our customer service department (refer injector chart below for sizes).

Burner	Natural Gas		Universal LPG	
	Hourly Gas Consumption (MJ)	Injector mark	Hourly Gas Consumption (MJ)	Injector mark
Small	4,0	90	3,25	50
Medium	6,5	118	6,25	67
Large	11,5	155	9,5	85
Big wok (Center outer)	15	110	14,6	68
Big wok (Center inner)	included in above	85	included in above	43

Before conversion the cooktop must be disconnected from the electricity and gas valves must be turned to the OFF position.

- 1 Remove the trivets, burner caps and burner heads. Refer Fig. 7.
- 2 Change the injectors using a 7-mm socket wrench and be sure to tighten them down properly so that they are fully airtight. Refer Fig. 8.
- 3 Re-assemble the burner component parts in reverse order.

NOTE: it is not necessary to adjust the primary air control on these burners.



Minimum flame adjustment.

- 1 Turn the control knob to minimum.
- 2 Remove the control knob from the valve spindle. Refer Fig. 9.
- 3 Apply pressure with the tip of the screwdriver to release the thread toward the tap's adjusting screw. Refer Fig.10. Do not remove the disk seal.
- 4 The adjustment screw is positioned at the rear lower section of the valve.
- 5 To adjust the minimum flame for N.G. replace the control knob onto the spindle, light the gas and turn the control knob to the small flame position. Screw the adjustment screw anti-clockwise to establish a minimum stable flame position. The flame should remain alight and not burn back to the injector when the valve is turned quickly from 'Full On' to the "Minimum flame" position and back a few times. To adjust the minimum flame position for ULPG the screw must be fully tightened down clockwise.
- 6 Refit the control knob. Never dismount the valve shaft: in the event of damage, change the entire valve.

