

Gaggenau

Use and care manual

CM470712

Fully Automatic Espresso Machine

Table of Contents

How to use these instructions	3
▲ Safety Definitions	3
IMPORTANT SAFETY PRECAUTIONS	4
Proposition 65 Warning:	6
Environmental protection	7
Saving energy	7
Disposing in an environmentally responsible manner	7
Getting to know your appliance	8
Contents of package	8
Assembly and components	9
Displays and controls	10
Function selector positions	10
Symbols	10
Colors and display	11
Automatic door opening	11
Additional information i and i [®]	11
Accessories	12
Switching the appliance on and off	12
Main switch	12
Sleep mode	13
Activating the appliance	13
Setting up the appliance	13
Initial settings	13
Setting water hardness	14
Water filter	14
Operation with or without water filter	14
Inserting the water filter	15
Filling the bean container	15
Preparing beverages	16
Beverage selection	16
Preparing coffee using freshly ground beans	17
Preparing two cups at the same time	17
Preparing coffee using ground coffee	18
Preparing coffee with milk	18
Preparing milk froth and warm milk	19
Preparing hot water	20
Setting the grinding level	20
Changing bean type	20

Individual beverages	21
Child lock	22
Activating the child lock	22
Deactivating the child lock	22
General settings	23
Setting the milk container weight	25
Messages	25
Home Connect	26
Setting Up	26
Home Connect settings	28
Remote Start	29
Remote Diagnostics	29
Information on Data Protection	29
Declaration of Conformity	29
Wi-Fi [®] Module	29
Daily care and cleaning	30
Daily care	30
Cleaning the milk system	30
Cleaning the brewing unit	32
Service programs	33
Cleaning	34
Descaling	34
Cleaning and descaling	34
Fill the water tank with fresh water	35
Emptying program	35
AQUA-STOP pledge	36
Technical specifications	36
Simple troubleshooting	37

Additional information on products, accessories, replacement parts and services, as well as the Use and care manual and the Installation instructions can be found at www.gaggenau.com and in the online shop www.gaggenau.com/zz/store

How to use these instructions

You can open up the front cover of this instruction manual. There you will find illustrations of the appliance with each part numbered. These numbers will be referred to throughout the text.

Example: brewing unit (15)

These instructions also show display texts and symbols in a special way. This enables you to clearly see where we refer to texts or symbols that are marked or displayed on the appliance.

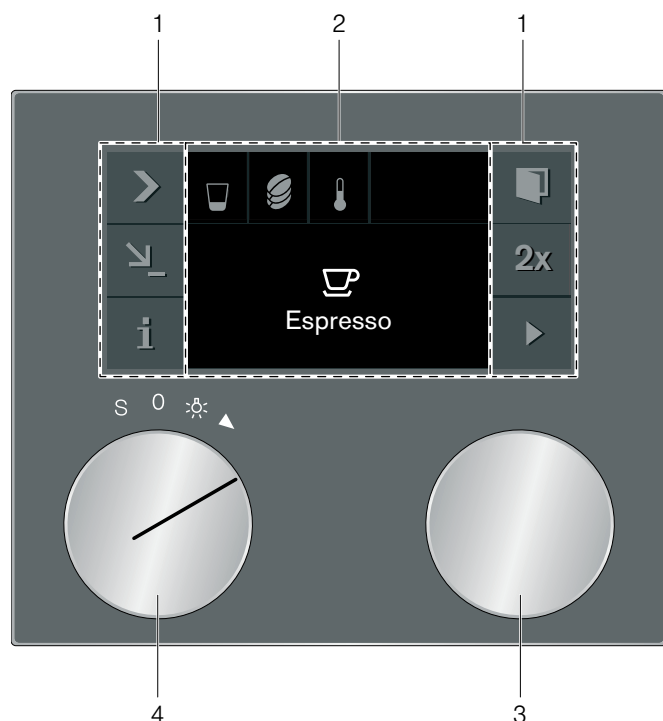

1	Control panel	These areas are touch-sensitive. Touch a symbol to select the applicable function.
2	Display	The display shows current settings and options, for example.
3	Rotary selector	With the rotary selector you can select the desired beverage and make other settings.
4	Program selector	With the program selector you can call up your saved favourite beverages or the basic settings.

The appliance comes with a quick reference guide where you can find the most important functions at a glance. It can be stored in the accessory drawer of the appliance.

Pay special attention to the important safety instructions in the “Important Safety Precautions” section.

⚠ Safety Definitions

⚠ WARNING

This indicates that death or serious injuries may occur as a result of non-observance of this warning.

⚠ CAUTION

This indicates that minor or moderate injuries may occur as a result of non-observance of this warning.

NOTICE

This indicates that damage to the appliance or property may occur as a result of non-compliance with this advisory.

Note: This alerts you to important information and/or tips.



IMPORTANT SAFETY PRECAUTIONS

READ AND SAVE THESE INSTRUCTIONS

When using electrical appliances, basic safety precautions should always be followed, including the following:

1. Please read and follow the operating instructions carefully and keep them for later reference. If the unit is transferred to another party, please be sure to include these instructions.
2. Check the appliance after unpacking it. Do not connect the appliance if it has been damaged in transit.
3. Do not touch hot surfaces. Use handles or knobs.
4. Be sure that all components are assembled and fastened properly.
5. To protect against fire, electric shock and injury to persons, do not immerse cord, plugs, or body in water or in any other liquid. See Use and Care Guide for cleaning.
6. Close supervision is necessary when the appliance is used by or near children.
7. Unplug from outlet when not in use and before cleaning. Allow to cool before putting on or taking off parts, and before cleaning the appliance.
8. Do not operate any appliance with a damaged cord or plug or after it malfunctions, or has been damaged in any manner. Return appliance to the nearest authorized service facility.
9. The use of accessories attachments not recommended by the appliance manufacturer may result in fire, electric shock or injury to persons.
10. Do not use outdoors or in a damp area.
11. Do not let cord hang over edge of table or countertop, or touch hot surfaces.
12. Do not place unit or components on or near a cooktop or range, or in a heated oven.
13. This appliance must not be used by children without adult supervision or by disabled persons without assistance.
14. If water is leaking from the inlet hose, turn off the tap at once. When connecting or working on the water pipe, disconnect the appliance from the mains power supply.
15. Always attach plug to appliance first, then plug cord into the wall outlet. To disconnect, turn control to "off", then remove plug from wall outlet.
16. Do not use appliance for anything other than its intended use.
17. Save these instructions.
18. Please note the special information on cleaning in the instructions.

IMPORTANT: This appliance is designed for domestic and not commercial use.

Use indoors at room temperature only.

Protect the appliance against freezing or it will be damaged.

Supervise children to ensure that they do not play with the appliance.



IMPORTANT SAFETY PRECAUTIONS

READ AND SAVE THESE INSTRUCTIONS



WARNING

To reduce risk of fire and electric shock:!

Installation

Connect and operate the appliance only according to the rating plate specifications.

Use appliance only with transformer which is identified as Type 8001010566.

Do not connect the appliance to or operate it by means of a time switch or remote control socket.

The unit must not be operated with an extension cord.

Use the Coffeemaker only if power cord and appliance show no signs of damage.

Should a problem occur, pull the plug and disconnect from the power immediately.

Never immerse the appliance or power cable in water or any liquid.

Avoid spillage on the connector.

Grounding

This appliance may only be connected to a power supply with 120 Volt AC via a correctly installed receptacle with ground.

Repairs

To avoid potential hazards, repairs must only be carried out by authorized repair service personnel.

If the power cord of this appliance is damaged, it must be replaced by a original replacement power cord, which can be purchased from our Customer Service Department.



WARNING

To avoid the risk of injury:!

Do not drink or come into contact with cleaning or descaling materials. Keep cleaning materials and descaling tablets out of the reach of children. They may be toxic.



CAUTION

To avoid the risk of scalding:

Please note that the beverages are very hot when dispensed.

Do not use chemically softened water!



CAUTION

Risk of scalding (Home Connect)

If an unattended remote start takes place, third parties might be scalded if they reach under the coffee dispenser during drinks dispensing. You should therefore make sure that with an unattended remote start there is no risk to other people, in particular not to children, or to property.



CAUTION

To avoid the risk of suffocation:

Do not allow children to play with packaging material. Store small parts safely as they can be a choke hazard.

IMPORTANT SAFETY PRECAUTIONS

READ AND SAVE THESE INSTRUCTIONS

CAUTION

To avoid the risk of injury:
Keep children away from the appliance and power cable.

CAUTION

To avoid the risk of injury:
Do not reach into the grinding unit. Be careful not to pinch your fingers when closing the door. A misuse of the appliance can potentially lead to injury.

CAUTION

To avoid the risk of burns:
The beverage outlet gets very hot. After use, allow to cool down first before touching. After use, the heating element surfaces and warming plate can retain heat. Wait until cool before touching.
Freshly prepared beverages are very hot. Leave to cool a little as necessary.

CAUTION

To avoid the risk of influence electronic implants:
The appliance contains permanent magnets that may influence electronic implants such as pacemakers or insulin pumps. Persons wearing electronic implants must maintain a minimum distance of 4 inches from the front of the appliance and from the following parts upon removal: milk container, milk system, water tank and brewing unit.

Proposition 65 Warning:

This product may contain a chemical known to the State of California, which can cause cancer or reproductive harm. Therefore, the packaging of your product may bear the following label as required by California:

STATE OF CALIFORNIA PROPOSITION 65 WARNING:

 **WARNING**

Cancer and Reproductive Harm - www.P65Warnings.ca.gov

Environmental protection

Saving energy

- If the appliance is not being used, switch it off.
- Set the interval for automatic switch-off to the lowest value.
- If possible, do not interrupt coffee or milk froth dispensing. Stopping a process prematurely results in higher energy consumption and the drip tray fills up more quickly.
- Descale the appliance regularly to avoid a build-up of limescale. Limescale residue results in higher energy consumption.

Disposing in an environmentally responsible manner

Dispose of packaging in an environmentally responsible manner.

Please ask your dealer about current means of disposal.

Getting to know your appliance

Use this section to familiarize yourself with your new appliance. The control panel and the individual operating controls are explained. You will also be informed about the accessories.

Further information about the appliance, such as how to change the opening angle of the door, can be found in the enclosed installation instructions.

Contents of package

(For use)

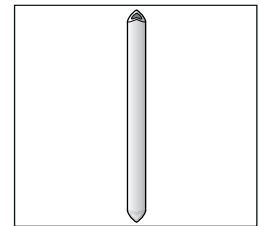
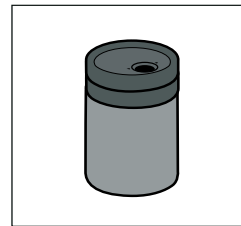
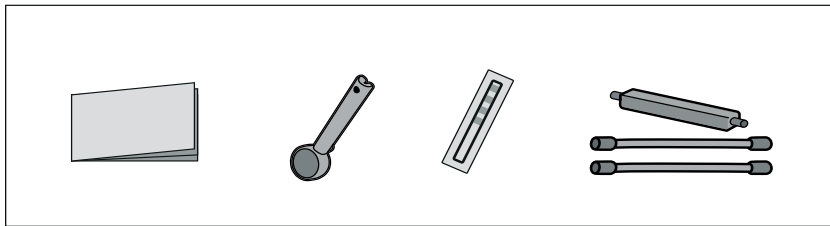
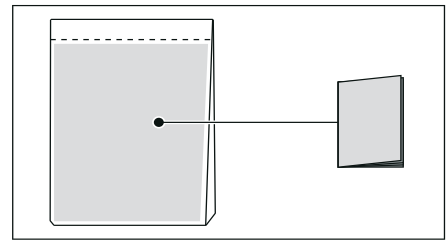
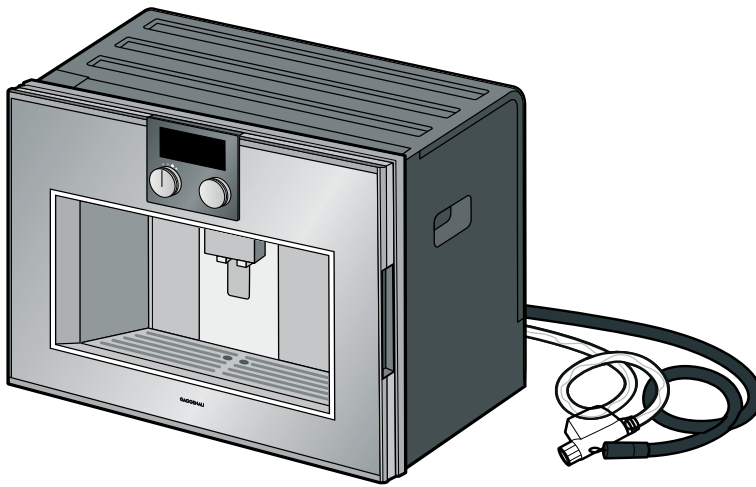

Assembly and components

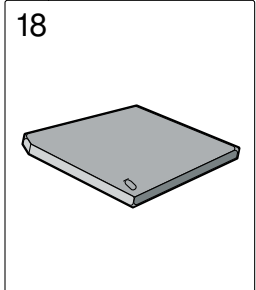
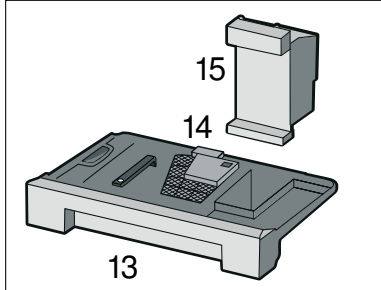
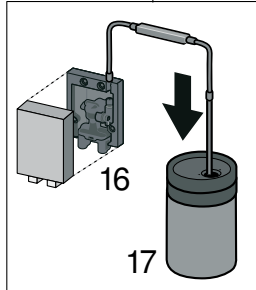
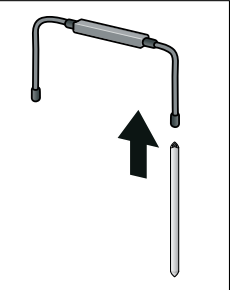
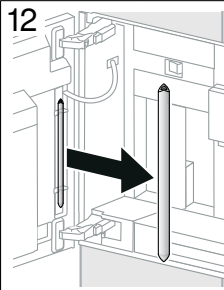
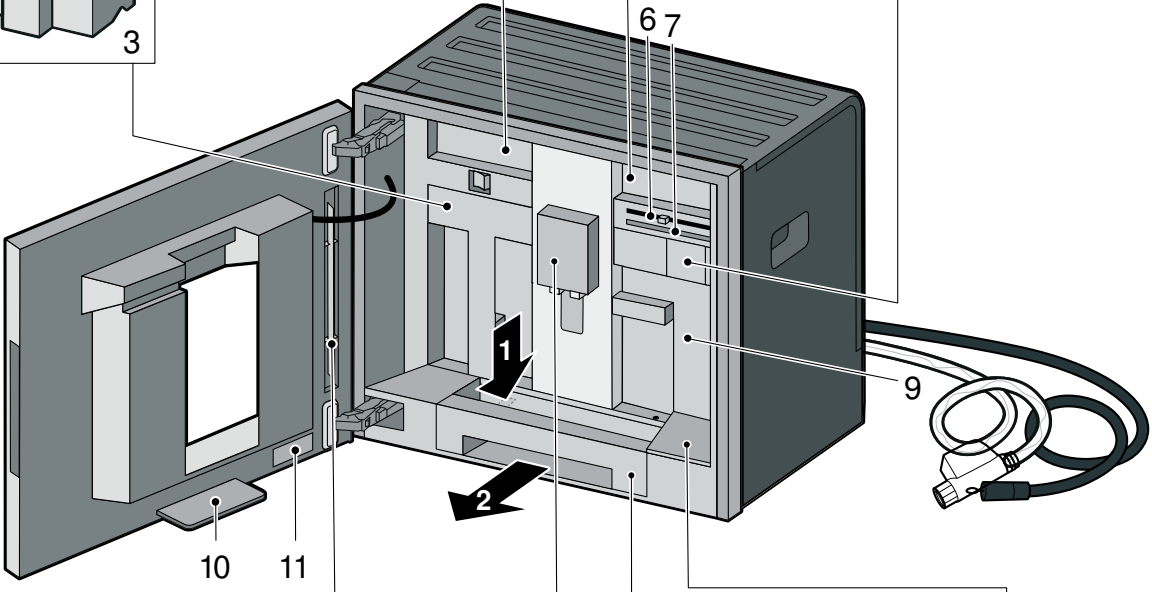
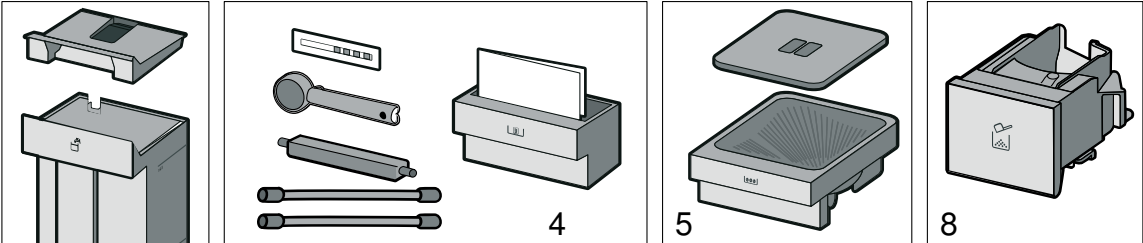
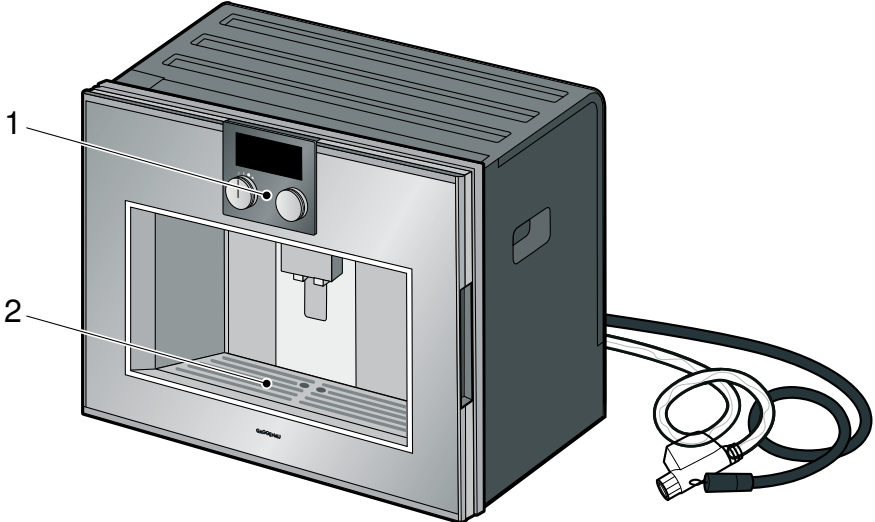

1	Display and controls
2	Shelf, e.g. for a cup
3	Water tank with lid
4	Accessory drawer (for quick reference guide and accessories)
5	Bean container
6	Grinding level adjustment
7	Magnetic holder (for milk hoses' connecting element)
8	Ground coffee drawer
9	Protective cover (for brewing unit)
10	Collecting tray
11	Rating plate
12	Holder (for milk tube)
13	Drip tray
14	Drain filter
15	Coffee residue container
16	Beverage dispenser and milk system, height-adjustable
17	Milk container
18	Shelf (scales) for milk container, removable

Displays and controls

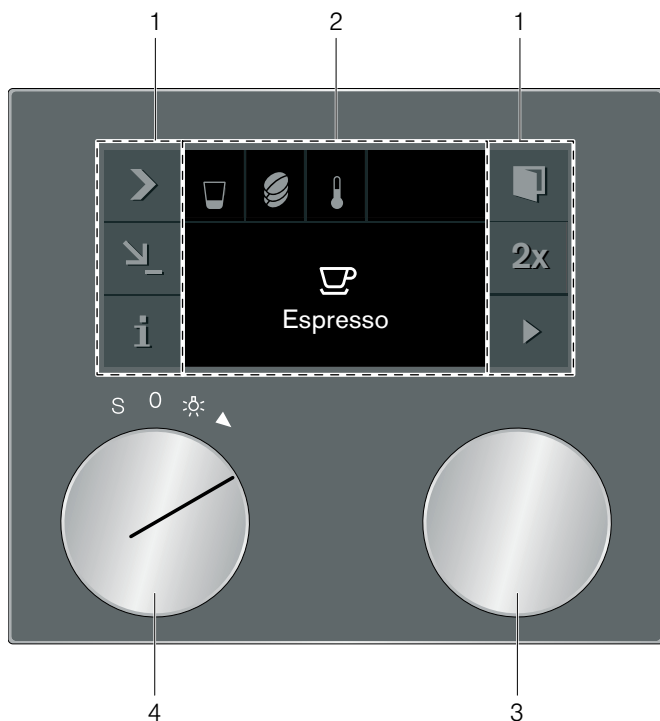

1	Control panel	These areas are touch-sensitive. Touch a symbol to select the applicable function.
2	Display	The display shows current settings and options, for example.
3	Rotary selector	With the rotary selector you can select the desired beverage and make other settings.
4	Function selector	You can use the function selector to call up beverages or the favorite drinks you have saved.

Function selector positions

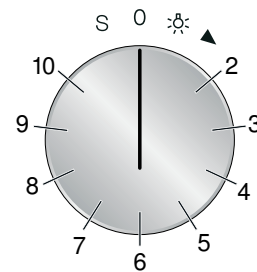

Position	Function
0	Off position
☀	Light
2	Beverage selection
3 - 10	Memory locations for individual beverages
S	Service programs/General settings

Symbols

The following overview outlines the most common symbols you will come across when operating the appliance.

Symbol	Function
▶	Start
■	Stop
X	Cancel
✓	Confirm/save settings
>	Selection arrow
🔒	Open the door
📶	Network connection (Home Connect)
i	Launching additional information
🗨	Calling up additional tips
↙	Edit settings
↘	Save individual beverage
🗑	Quick capacity selection
2 x	2x beverage
🔒	Child lock

Colors and display

Colors

The various colors serve to guide you in the various adjustment situations.

Orange	First settings Main functions, messages
Blue	Basic settings Cleaning
White	Adjustable values

Appearance

The symbols, values and displays may change, depending on the situation.

Standard	Values and symbols which have just been selected will be displayed in a larger font.
Reduced display screen	After a short while, the amount of information shown on the display will be reduced and only the most important information will remain. This function is activated in the basic settings ex works and can be deactivated.

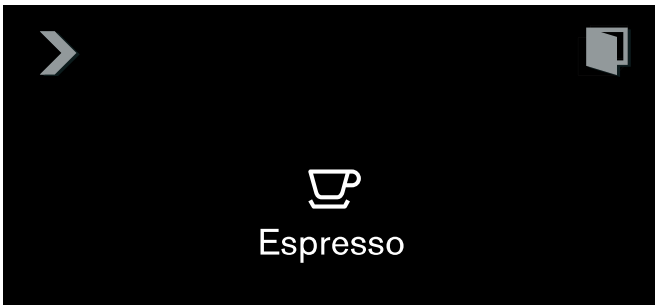

Automatic door opening

When you touch the  symbol, the appliance door springs open and you can open it fully with the handle recess at the side.

Automatic door opening does not work when the child lock is activated or in the event of a power failure. You can open the door manually with the handle recess at the side.

Additional information **i** and **i**[Ⓢ]

By touching the **i** symbol, you can call up additional information.

During operation, you will, for example, receive information regarding the number of beverages already dispensed.

If the function selector is set to **S**, you will, for example, receive information about when the appliance needs to be descaled or cleaned or when the water filter needs changing. You can use this information to start up a service program that is due soon, for example.

The **i**[Ⓢ] symbol appears for important action prompts. New messages are also displayed for several seconds on the display. These messages disappear automatically after a few seconds, or must be confirmed with . A list of messages can be displayed by touching the **i**[Ⓢ] symbol. The message disappears when the required action has been carried out.

Accessories

The fully automatic espresso machine has a drawer for storing accessories such as the quick reference guide or measuring spoon inside the appliance. After opening the door, you can use the magnetic holder and the clip for the individual parts, such as the milk hose set. The holder for the milk tube is situated on the inside of the door.

The appliance is equipped with the following accessories as standard:

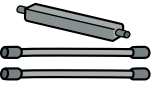
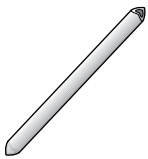
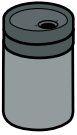
	Measuring spoon For adding ground coffee.
	Milk hose set For connecting the milk container.
	Milk tube For inserting into the milk container, milk cartons and milk bottles or for running a service program.
	Milk container Capacity 17 oz (0.5 liters). The milk container has been designed especially for use together with this fully automatic coffee machine. It is intended solely for use in the household and for storing milk in the refrigerator.

The following accessories can be reordered by contacting our customer service:

- Water filter (order no.: 12008246)
- Cleaning tablets (order no.: 00311823)
- Descaling tablets (order no.: 00311820)
- Care set (order no.: 00576331)
- Milk container (order no.: 11019259)
- Door hinge restrictor 92° opening angle (order no.: 00636455)
- Bean container (order no.: 11015223)
- Water inlet hose extension (order no.: 11019575)

Switching the appliance on and off

Main switch

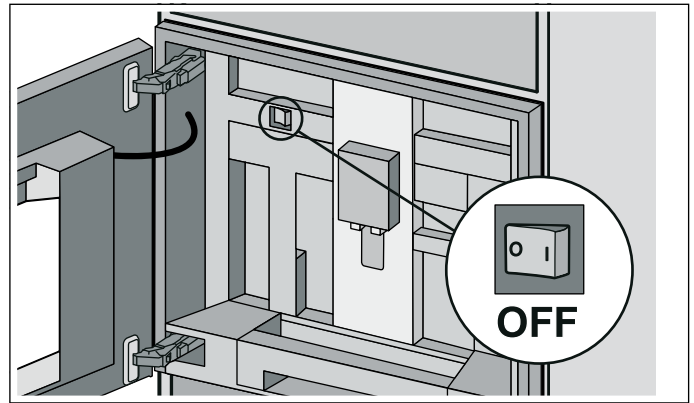

The main switch is used to switch the appliance on and off.

If the appliance is switched off at the main switch, the power supply is interrupted.

The appliance is programmed so that it switches to "Standby" mode automatically after about 30 minutes. This timespan can be changed. → "General settings" on page 23

The appliance rinses automatically when it is switched on at the main switch. Exception: The appliance was only switched off a few minutes beforehand.

Notes

- Do not press the main switch during operation. If you want to manually switch off the appliance, you must first set the function selector to **0** so that it rinses automatically. Then switch off the appliance using the main switch.
- The appliance is equipped with a sensor. If a milk container is present, this will be correspondingly shown on the display when switching to the energy saving mode (function selector set to **0**). If there is milk in the container, please keep in the refrigerator.

Sleep mode

The appliance goes into sleep mode if the function selector is turned to **0** or if the child lock is activated.

Activating the appliance

In order to leave sleep mode, or to activate the display when it has been switched off, turn the function selector.

Now you can set the desired function. Read the appropriate chapters to learn how to set functions.

Notes

- If the drip tray is not in place, the appliance cannot be switched on and no water flows out of the beverage dispenser.

The message "Insert trays" appears.

- If "Standby screen = off" is selected in the factory setting, you must turn the function selector to exit the standby mode.

Setting up the appliance

Note: Only use the appliance in frost-free rooms. If the appliance was transported or stored at temperatures below 32 °F (0 °C), you must wait for at least 3 hours before using it.

Before the appliance can be switched on and used, it must be assembled and connected according to the enclosed installation instructions.

Initial settings

Notes

- The query appears automatically when first switched on after connection to a power outlet.
 - You can change the settings at any time. → "General settings" on page 23
1. Switch on the appliance at the main switch.
The preset language appears on the display.

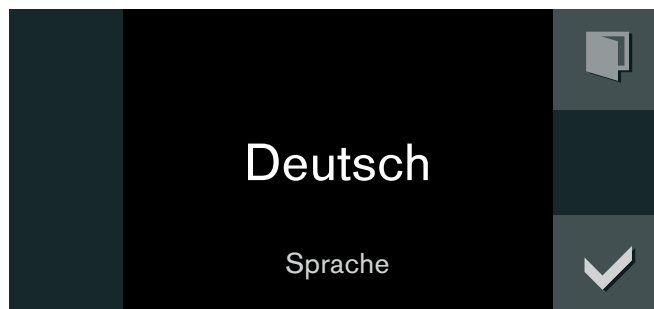

2. Use the rotary selector to select the required display language.
3. Press ✓ to confirm.
The temperature unit appears in the display.
4. Use the rotary selector to select the required temperature unit.
5. Press ✓ to confirm.
The preset capacity unit appears on the display.
6. Use the rotary selector to select the required capacity unit.
7. Press ✓ to confirm.
The preset weight unit appears on the display.
8. Use the rotary selector to select the required weight unit.
9. Press ✓ to confirm.

The display shows "Initial set-up complete". Confirm with ✓. The appliance is now ready to use.

Note: When the language is changed, the system is restarted; this process takes a few seconds.

Setting water hardness

It is important to set the water hardness correctly, so that the appliance indicates accurately when the descaling program should be run. The preset water hardness is level 4. If a water softening unit is installed in the household, select the "Water softening unit" setting. You can check the water hardness using the enclosed test strip or by asking your local water supplier.

1. Briefly immerse the enclosed test strip in fresh tap water, leave it to drip off and read off the result after one minute.
2. Rotate function selector to **S**.
3. Use the rotary selector to select "General settings" and touch the ✓ symbol.
4. Use the rotary selector to select "Water hardness".
5. Touch the ↘ symbol.
6. Using the rotary selector, set the measured water hardness.
7. Press ✓ to confirm.

The setting is saved. Touch **X** in order to exit the general settings.

The table shows the allocation of the levels to the different degrees of water hardness:

Level	Water hardness g/gal (US)
1	1.0426 - 7.2985
2	8.3412 - 14.597
3	15.64 - 21.896
4	22.938 - 31.279

Water filter

Operation with or without water filter

You can use the appliance with or without a water filter. To ensure that the descaling display of the appliance functions correctly, you must state in the general settings whether a water filter is used.

1. Rotate function selector to **S**.
2. Select "General settings" using the rotary selector.
3. Touch the ✓ symbol.
4. Select "Water filter" using the rotary selector.
5. Touch the ↘ symbol.
6. Use the rotary selector to select either "Available" (with water filter) or "Not available" (without water filter).
7. Press ✓ to confirm.
For the setting "Available", the rinse program starts. Proceed according to the information on the display.
8. Touch the **X** symbol to exit the general settings menu.

A water filter lessens limescale deposits and reduces impurities in the water. The appliance also does not need to be descaled so often.

Inserting the water filter

New water filters must always be rinsed after being fitted.

1. Rotate the function selector to **S**.
2. Select "Change water filter" using the rotary selector.
3. Touch the ✓ symbol.
4. Fit the water filter in the water tank.

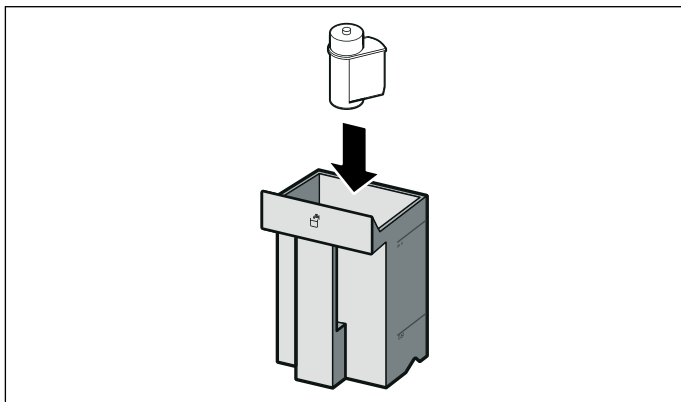

5. Remove the milk hose from the milk container and close the door.
6. Touch the ✓ symbol.

The water runs through the filter to rinse it. After the rinsing process, confirm with ✓. The appliance is again ready for use.

Rinsing the filter also activates the setting for the "Change water filter" display. When the display "Please change water filter" is shown, or at the latest after two months, the filter is no longer effective. It needs to be replaced for reasons of hygiene and so that the appliance does not become calcified (which could damage the appliance).

Replacement filters can be obtained from customer service. → "Accessories" on page 12

Note: If you leave the appliance for a prolonged period without using it (for example when on vacation), it is best to rinse the existing filter before preparing beverages. To do this, simply dispense a cup of hot water.

Filling the bean container

Using your appliance, you can prepare coffee using freshly ground coffee beans or ground coffee. Only fill the ground coffee shortly before preparing the beverage. → "Preparing coffee using ground coffee" on page 18

1. Open the door.
2. Pull the bean container out, remove the lid and fill the container with beans. Replace the lid and insert the bean container again.

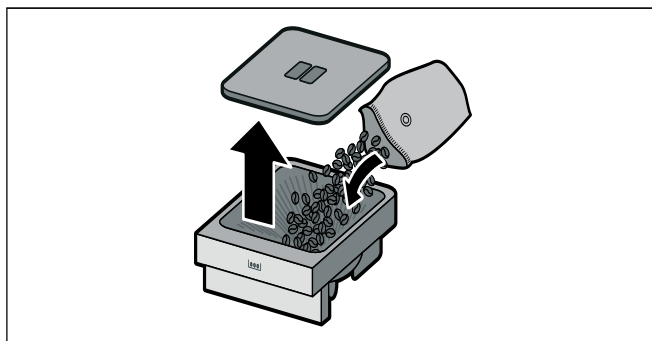

Note: Coffee beans that have been glazed, caramelized, or that contain other sugary additives block the brewing unit. Only use pure bean mixtures that are suitable for use in fully automatic espresso machines.













3. Close the door.

Preparing beverages





Beverage selection

Notes

- The integrated fan switches on each time a beverage is dispensed and switches off again after a few minutes.
- The very first cup of coffee dispensed will not develop the full aroma. The same applies if the machine has not been used for some time.
- The appliance is preprogrammed with the standard factory settings for optimal operation.
- After setting up the appliance, you will achieve a suitably thick and stable "crema" only after the first few cups have been dispensed.

	Ristretto	Concentrated espresso. Best served in small, thick-walled cups. Preheat cups with hot water.
	Espresso	Concentrated coffee. Best served in small, thick-walled cups. Preheat cups with hot water.
	Coffee	Coffee
	Americano	1/3 espresso, is topped up with 2/3 hot water.
	Hot water	For preparing hot beverages, e.g. tea, or to preheat cups.
	Milk froth	For preparing speciality white coffees.
	Warm milk	As a beverage or as an ingredient in certain coffee beverages.
	Cafe Latte	1/2 coffee + 1/2 milk; best served in a wide-rimmed cup.
	Latte Macchiato	A specialty drink, served in a glass featuring three layers: at the bottom hot milk, in the middle espresso, and at the top milk froth.
	Flat White	Espresso with frothed milk.
	Cappuccino	1/3 espresso + 1/3 milk + 1/3 milk froth; best served in a cup.
	Espresso Macchiato	Espresso finished with milk froth.

You may be able to select further options depending on your choice of beverage:

	Capacity	Small - Medium - Large - Extra large
	Strength	Very mild - Mild - Medium - Strong - Very strong - Extra strong etc., not available for milk froth, warm milk and hot water
	Temperature	Hot - Very hot - Extra hot not available for milk froth and warm milk. Different temperatures can be selected for hot water.
	Mixing ratio	Setting for the proportion of milk, only available for coffee beverages with milk.

Aroma function "Extra strong"

The longer the coffee is brewed, the more bitter substances and undesired aromas are released. This has a negative effect on the taste and makes the coffee less easily digestible. Your appliance therefore has a special "Aroma" function for very strong coffee. The machine dispenses half of the required quantity and then grinds and brews fresh beans for the other half, so only the pleasant-tasting and easily digestible aromas are released.

The "Aroma" function "Extra strong" or "Extra strong 3 ☉ 2x" is only available for certain settings. The coffee is prepared in two stages for this setting. Wait until the process is fully completed.

Preparing coffee using freshly ground beans

The appliance must be switched on. The bean container must be filled.

1. Rotate function selector to position 2.

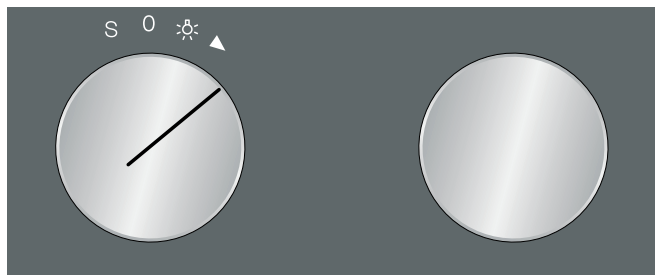

2. Use the rotary selector to select the desired beverage, e.g. coffee.

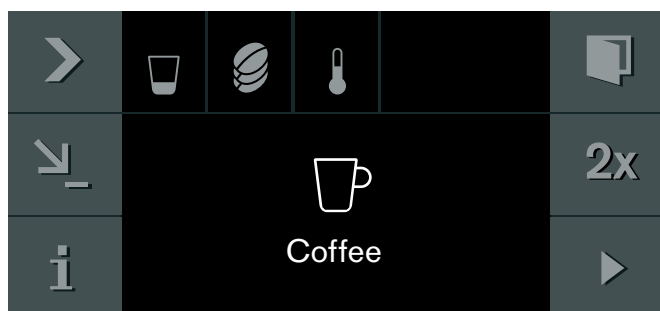

3. Place a cup under the beverage dispenser.
4. Touch the > symbol.
5. Set the size using the rotary selector.

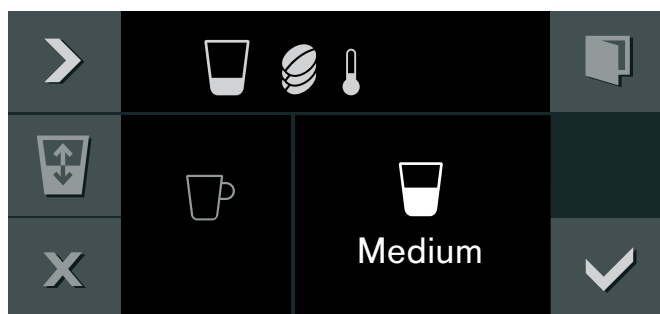

6. Touch the > symbol.
7. Set the strength using the rotary selector.

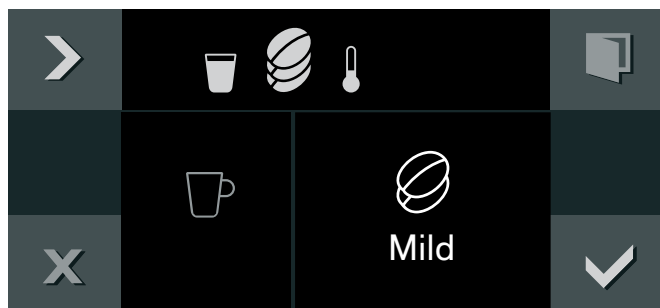

8. Touch the > symbol.

9. Set the temperature using the rotary selector.

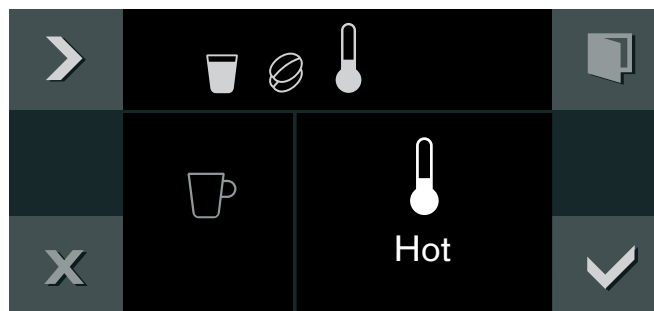

10. Press ✓ to confirm the settings.

11. Start with ▶.

The beverage is brewed and then dispensed into the cup.

Notes

- While the beverage is dispensed, the ■ symbol is displayed. Touch this symbol to stop the beverage being prepared.
- Using the ↵ symbol, you can save the current beverage: Touch the ↵ symbol, turn the function selector to a free memory location and save the entry. → "Individual beverages" on page 21

Preparing two cups at the same time

You have the option of dispensing two beverages simultaneously:

1. Select the beverage and use the rotary selector to adopt settings such as temperature if desired.
2. Touch the symbol 2x.
3. Place two cups, or similar, underneath the beverage dispenser.
4. Start with ▶.

The selected beverage is brewed and then dispensed into the cups.

Note: The coffee is prepared in two stages. Wait until the process is fully completed.

Preparing coffee using ground coffee



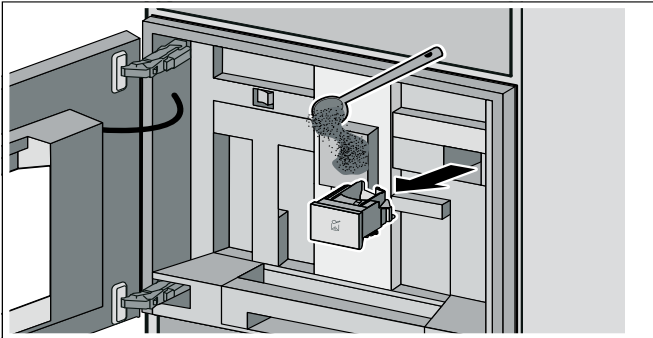

The appliance must be switched on.

Important: Remove cups or glasses before opening the door, as they may fall otherwise.

1. Rotate function selector to position 2.
2. Open the door.
3. Using the measuring spoon, fill a maximum of two level spoonfuls of ground coffee into the ground coffee drawer. Close the ground coffee drawer.



Note: Do not fill the ground coffee drawer with beans or instant coffee.

4. Close the door.
5. Use the rotary selector to select the desired beverage (beverages made from ground coffee are identified with the  symbol).
6. Place a cup under the beverage dispenser.
7. Touch the  symbol.
8. Set the size using the rotary selector.
9. Touch the  symbol.
10. Set the temperature using the rotary selector.
11. Press  to confirm the settings.
12. Start with .

The beverage is brewed and then dispensed into the cup. For another cup of coffee, pour in more ground coffee and repeat the process.

Notes

- While the beverage is dispensed, the  symbol is displayed. Touch this symbol to stop the beverage being prepared.
- If coffee is not dispensed within 90 seconds, the brewing chamber empties itself automatically to prevent an overflow.
- The "Aroma" function is unavailable when using ground coffee. Similarly, it is not possible to dispense two cups at once when using ground coffee.

Preparing coffee with milk

WARNING

Risk of burns!

The milk system becomes very hot. After use, always let it cool down before you touch it.

You can transfer the milk into the supplied milk container or into a milk jug, for example, or draw the milk directly from a carton. → "Setting the milk container weight" on page 25

Important: Remove cups or glasses before opening the door, as they may fall otherwise.

Using the milk container:

- Open the door.
- Push the beverage dispenser down completely.
- Remove the cover of the beverage dispenser towards the front.
- Attach a milk hose from the milk system to the beverage dispenser and feed it outward through the opening at the top.
- Attach the connecting element of the milk system to the magnetic holder (on the inside of the appliance).
- Place the milk container on the right next to the beverage dispenser. Connect the milk tube to the milk hose and then guide the milk tube into the milk container. The end of the milk tube must be immersed in the milk.

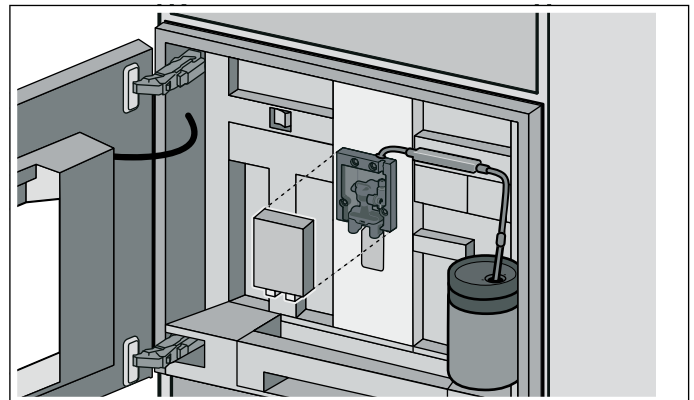

- Close the door.

Using a milk carton or other container:

- Open the door.
- Push the beverage dispenser down completely.
- Remove the cover of the beverage dispenser towards the front.
- Feed the milk system's milk hose outward through the opening at the top.
- Attach the magnetic holder to the appliance.
- Place the full milk carton on the right next to the beverage dispenser. Connect the milk tube to the milk hose and then guide the milk tube into the milk carton. The end of the milk tube must be immersed in the milk.
- Close the door.

To prepare a beverage:

The appliance must be switched on. The bean container must be filled.

1. Rotate function selector to position 2.
2. Using the rotary selector, select a coffee beverage with milk. To select a beverage made using ground coffee, you must first fill the ground coffee drawer.
3. Place a cup or glass under the beverage dispenser.
4. Start with ▶.

- or -

Touch the ▶ symbol first, then set the size or strength, for example, using the rotary selector and confirm with ✓.

The milk is drawn in and prepared, after which the coffee is brewed.

Notes

- While the beverage is dispensed, the ■ symbol is displayed. Touch this symbol to stop the beverage being prepared.
- Using the ↘ symbol, you can save the current beverage: Touch the ↘ symbol, turn the function selector to a free memory location and save the entry. → *"Individual beverages" on page 21*
- Dried-on milk residues are difficult to remove, so always clean the milk system after every use. → *"Cleaning the milk system" on page 30*

Preparing milk froth and warm milk**⚠ WARNING****Risk of burns!**

The milk system becomes very hot. After use, always let it cool down before you touch it.

To prepare a beverage:

The appliance must be switched on.

1. Rotate function selector to position 2.
2. Connect the milk hose. → *"Preparing coffee with milk" on page 18*
3. Select "Milk froth" or "Warm milk" with the rotary selector.
4. Place a cup or glass under the beverage dispenser.
5. Touch the ▶ symbol.
6. Set the size using the rotary selector.
7. Press ✓ to confirm the settings.
8. Start with ▶.

The milk is drawn in and subsequently flows into the cup or the glass.

Notes

- While the beverage is dispensed, the ■ symbol is displayed. Touch this symbol to stop the beverage being prepared.
- Using the ↘ symbol, you can save the current beverage: Touch the ↘ symbol, turn the function selector to a free memory location and save the entry. → *"Individual beverages" on page 21*
- Dried-on milk residues are difficult to remove, so always clean the milk system after every use. → *"Cleaning the milk system" on page 30*

Preparing hot water

! WARNING

Risk of burns!

The milk system becomes very hot. After use, always let it cool down before you touch it.

The appliance must be switched on.

1. Remove the milk tube from the milk container.
2. Rotate function selector to position 2.
3. Select "Hot water" with the rotary selector.
4. Place a cup or glass under the beverage dispenser.
5. Touch the > symbol.
6. Set the size using the rotary selector.
7. Touch the > symbol.
8. Set the temperature using the rotary selector.
9. Press ✓ to confirm.
10. Start with ▶.

The water is heated and then flows into the cup or glass.

Notes

- While the beverage is dispensed, the ■ symbol is displayed. Touch this symbol to stop the beverage being prepared.
- Using the ↵ symbol, you can save the current beverage: Touch the ↵ symbol, turn the function selector to a free memory location and save the entry. → "Individual beverages" on page 21

Setting the grinding level

! WARNING

Risk of injury!

Do not reach into the grinding unit.

Using the slider for the grinding level, the desired fineness of the ground coffee can be set between a fine grinding level (left) and a coarser grinding level (right).

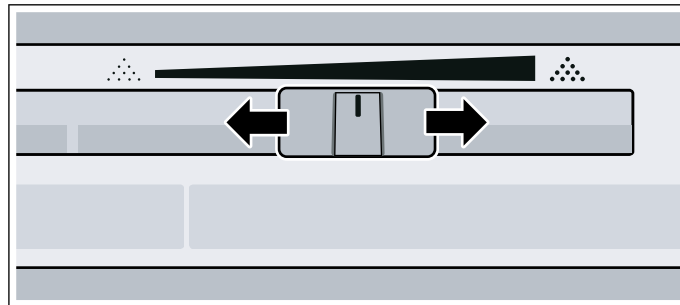

Notes

- The effects of the new grinding setting will only become apparent after the second cup of coffee.
- For dark roast coffee beans, choose a finer grinding level; for lighter beans, choose a coarser grinding level.
- If the display shows the message "Set coarser grinding level", the coffee beans are being ground too finely. Set a coarser grinding level; to do so, slide the slider to the right.
- Only make small changes to the grinding level setting.

Changing bean type

If you are using a new type of bean, the Empty grind function allows you to run the grinding unit until empty of your previous bean type.

The appliance must be switched on.

1. Remove the bean container and empty out the beans.
2. Add the new beans and reinsert the bean container.

The message "New type of coffee beans in bean container?" appears.

3. Press ✓ to confirm.

The grinding unit is then emptied of your previous bean type in two grinding stages.

Note: This message always appears when the bean container is inserted. If you do not want to empty the grinding unit, e.g. when only refilling with beans, confirm with ✕.

Individual beverages

You can define and store instructions for up to 8 different individual beverages.

1. Turn the function selector to one of the 8 memory locations.

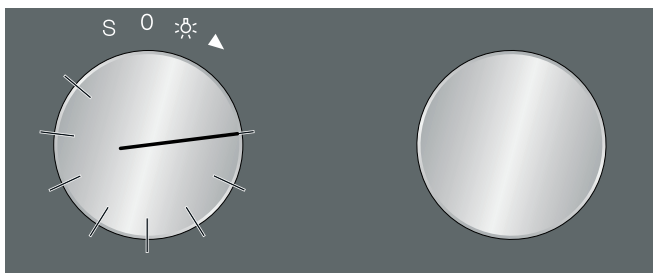

2. Use the ► symbol to select the desired beverage, capacity, strength, temperature and coffee-milk ratio and use the rotary selector to save the settings.

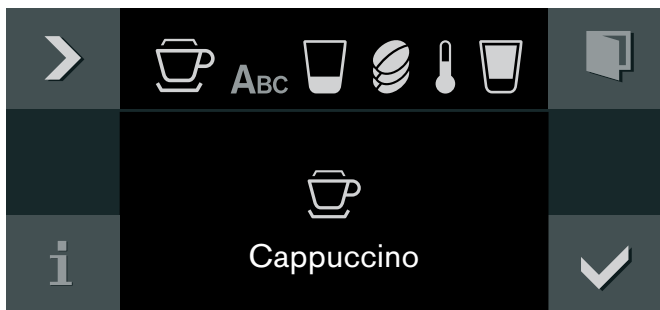

3. Enter the name of the beverage in "ABC".

Rotary selector	Select letters A new word always begins with a capital letter.
►A [^]	Press briefly: Moves the cursor to the right Press and hold: Shifts to umlauts and special characters Press twice: Adds a line break
►Ä	Press briefly: Moves the cursor to the right Press and hold: Shifts to normal characters Press twice: Adds a line break
⊗	Delete letters

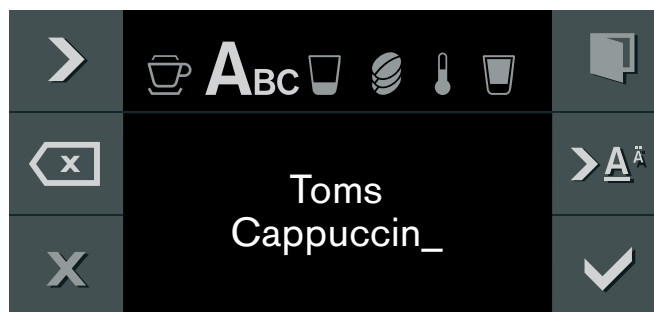

4. Save with ✓ or cancel and exit the menu with X.
5. Start with ►.

Depending on the beverage selected, the beans will be ground first, then the milk prepared and finally the coffee brewed.

Notes

- While the beverage is dispensed, the ■ symbol is displayed. Touch this symbol to stop the beverage being prepared.
- For entering a name, Latin characters, certain special characters and numbers are available.
- To change an existing memory location, touch the ↵ symbol and save a new setting.
- If a memory location is selected which is already occupied, the settings will be overwritten.

Child lock

The appliance has a child lock to prevent children operating it accidentally.

Notes

- You must set the child lock to "Available" in the general settings. → "*General settings*" on page 23
- If there is a power failure while the child lock is activated, the child lock may be deactivated when power is restored.

Activating the child lock

Prerequisite:

The function selector is set to 0.

Touch the  symbol for at least 6 seconds.

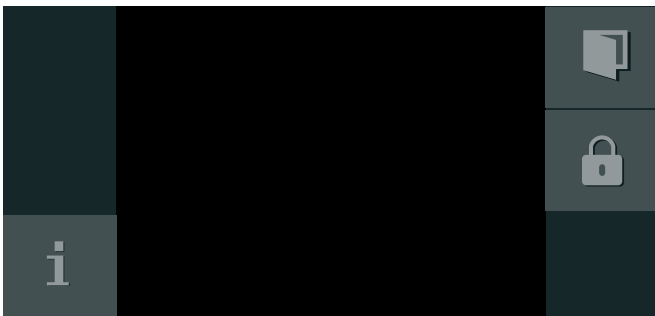

The child lock is activated. The  symbol is shown at the top of the display.

Deactivating the child lock

Prerequisite:

The function selector is set to 0.



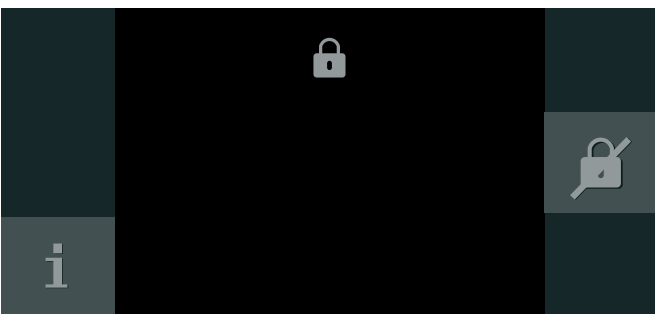

Touch the  symbol for at least 6 seconds.











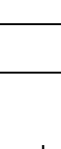
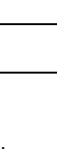
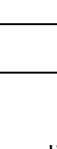
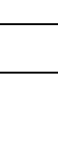
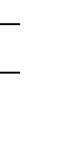









This deactivates the child lock. You can set the appliance as normal.

General settings

In the general settings, you can adapt your appliance individually.

1. Set the program selector to **S**.
 2. Select "General setting" with the rotary selector.
 3. Touch the  symbol.
 4. Set the required general setting with the rotary selector.
 5. Touch the  symbol.
 6. Set the general setting with the rotary selector.
 7. Save with  or cancel with  and quit the current general setting.
 8. Turn the program selector to **0** to quit the general setting menu.
- Changes are saved.

	Basic setting	Possible settings	Explanation
	Brightness	Stages 1, 2, 3, 4, 5*, 6, 7, 8	Setting display brightness
	Display screen	Minimized*/Standard	When 'Minimized' is set, only the most important details are displayed after a short time.
	Touchpad color	Gray*/White	Select the color of symbols on the touchpads
	Touchpad tone	Tone 1*/Tone 2/Off	Select the signal tone when touching a touchpad
	Touchpad volume	Levels 1, 2, 3, 4, 5*, 6, 7, 8	Sets the volume of the touchpad tone
	Signal volume	Levels 1, 2, 3, 4, 5*, 6, 7, 8	Sets the volume of the signal tone
	Light settings	Lighting options 1*-7	<input type="radio"/> Light off <input checked="" type="radio"/> Light on <input type="checkbox"/> Light only on when a beverage is being dispensed Other setting options will appear if you touch the  symbol.
	Standby after	5 minutes - 3 hours	Setting for the time, after which the appliance automatically rinses and switches to "Standby" mode.
	Water hardness	1-4*, water-softening system	Briefly immerse the enclosed test strip in fresh tap water, leave it to drip off and read off the result after one minute. Set the measured water hardness.
	Water filter	Available/Not available*	Available: Operate the appliance with a water filter. Not available: Operate the appliance without a water filter.
	Temperature format	°C / °F*	Set the temperature unit
	Capacity unit	ml/fl.oz.*	Set the capacity unit

	Capacity	+/-5 ml (0,2 fl.oz.) to 60 ml (2 fl.oz.)	Adjust the capacity to individual cup sizes. First select the beverage and then set the capacity.
	Unit of weight	g / oz*	Set the unit of weight
	Milk container weight	Standard*/Individual	Setting of weight detection. → "Setting the milk container weight" on page 25
	Language	German* / French / Italian / Spanish / Portuguese / Dutch / Danish / Swedish / Norwegian / Finnish / Greek / Turkish / Russian / Polish / Czech / Slovenian / Slovakian / Arabic / Hebrew / Japanese / Korean / Thai / Chinese / English US / English	Select language for the text display Note: When the language is changed, the system is restarted; this procedure takes a few seconds. Then the General settings menu is closed.
	Factory settings	Reset to factory settings	Confirm the question "Delete all settings and reset to factory settings?" with ✓ or cancel with X. Note: Individual beverages will also be deleted if the appliance is reset to factory settings. After resetting the factory settings, you will see the "Initial settings" menu.
	Demo mode	On/Off*	For presentation purposes only. The setting "Off" must be activated for normal operation. The setting is only possible in the first 3 minutes after switching on the appliance.
	Milk container reminder	30* minutes - 6 hours	Setting for the time, after which the reminder appears.
	Child lock	Not available*/Available	Available: The child lock can be activated. → "Child lock" on page 22
	Home Connect	Settings for connection to the home network and mobile devices.	Different setting options will be displayed depending on the connection status. → "Home Connect settings" on page 28

* Factory settings

Setting the milk container weight

Using the weight, the appliance detects the quantity of milk in the milk container to ensure that there is always sufficient milk to dispense a Latte Macchiato, for example. If there is too little milk in the container, a corresponding message will be displayed.

The weight of the supplied empty milk container and that of an empty milk carton (approx. 30 g) are already saved under "Standard". The appliance automatically detects whether the milk container or a milk carton is being used. However, you can also save the weight of your own milk container or a milk carton (if the weight of this deviates from the standard value) under the "Individual" setting.

Note: The container with milk must not exceed the maximum weight of 4.4 lbs (2 kg).

1. Rotate function selector to **S**.
2. Select "General settings" using the rotary selector.
3. Touch the ✓ symbol.
4. Select "Milk container weight" with the rotary selector.
5. Touch the ↘ symbol.
6. Select "Standard" (preset milk container weight) or "Individual" (own weight entry for the milk container) using the rotary selector.
7. Press ✓ to confirm.
8. For the "Standard" setting, the appliance automatically reverts to the selection layer of the "General settings" or
For the "Individual" setting, an individual milk container can now also be weighed and the weight saved.
9. Check whether the area for the milk container behind the door is free, confirm with ✓.
10. Place an empty container, e.g. a milk jug, into the area, confirm with ✓.
11. Close the door.
The weight of the container is determined and then displayed.
12. Press ✓ to confirm.
The changes are saved.
13. Touch the ✕ symbol to leave the "General settings" menu.

Messages

Depending on the setting in "General settings" or when dispensing a beverage with milk, various reminders or messages may be shown on the display:

"Reminder: Is the milk still fresh?"	Appears after a set time. → "General settings" on page 23 Please check whether the milk in the milk container is fresh.
"Reminder: Place milk in the refrigerator"	Appears when the appliance is switched off.
"Milk container connected?"	Message appears after selection of a beverage with milk. Please check and confirm.
"Not enough milk for the selected beverage"	Message appears when there is not enough milk in the milk container.

Home Connect

This appliance can be networked and also controlled remotely using a mobile device. The Home Connect app offers extra functions that complement the networked appliance perfectly. If the appliance is not connected to your home network, it can be operated as usual via the display.

The availability of the Home Connect function depends on the availability of Home Connect services in your country. Home Connect services are not available in every country. You can find more information on this at www.home-connect.com.

Notes

- Ensure that you follow the safety instructions in this instruction manual and that you comply with these even when you are away from home and are operating the appliance via the Home Connect app. You must also follow the instructions in the Home Connect app.
- Operating the appliance directly from the appliance always takes priority. It is not possible to operate the appliance using the Home Connect app during this time.
- Refer to the Home Connect documents supplied for more information.

Setting Up

To configure settings via Home Connect, you will need to have installed the Home Connect app on a mobile device.

Your appliance will also need to be connected to your home network and to the Home Connect app. You can choose between the following connection types:

- Connection to LAN cable or via WLAN: first set up the app. Then connect the appliance to the home network.

Notes

- The appliance detects when a LAN cable is connected to the appliance. The appliance should be connected to Home Connect via WLAN. Switch to WLAN in the basic settings.
- The app will guide you through the entire registration process. In case of doubt, follow the instructions in the app.

Installing the app

Install the Home Connect app on your mobile device (e.g. tablet PC or smartphone).

1. On your mobile device, go to the App Store (Apple devices) or the Google Play Store (Android devices).
2. Enter the search term "Home Connect".
3. Select the Home Connect app and install it on your mobile device.
4. Launch the app and set up Home Connect access.
The app will guide you through the registration process.

Connecting the appliance to your home network (LAN)









The appliance must be connected to your home network using a LAN cable.

The network connection will be established automatically when the appliance is connected to the mains electricity supply for the first time and put into operation.

Follow the instructions in the app.









Connecting the appliance to your home network (WLAN with WPS)

Requirements:

- Your router must have a WPS button. You will find information about this in the manual for your router.
 - You need to be able to access your router.
1. In the basic settings, select  "Home Connect".
 2. Touch the  symbol.
 3. Turn the rotary selector to "WLAN".
 4. Confirm by touching the  symbol.
A message about the WPS function will appear.
 5. Touch the  symbol to continue.
 6. Turn the rotary selector to "Automatic (WPS)".
 7. Touch the  symbol to start the connection process.
 8. Press the WPS button on the home network router within the next 2 minutes.
If the display shows "Network connection successful", the connection process is complete.
 9. Touch the  symbol to continue.
"Connect to app" appears.
 10. Touch the  symbol.
"Add mobile device" appears.
 11. Touch the  symbol to confirm.
Follow the instructions in the app.

If the display shows "Network connection successful", the connection process is complete. Follow the instructions in the app.

Connecting the appliance to your home network (WLAN without WPS)







1. In the basic settings, select  "Home Connect".
2. Touch the  symbol.
3. Turn the rotary selector to "Wi-Fi".
4. Confirm by touching the  symbol.
A message about the WPS function will appear.
5. Touch the  symbol to continue.
6. Turn the rotary selector to "Manual".
7. Touch the  symbol to start the connection process.
The appliance will set up its own "Home Connect" WLAN network to which the tablet or smartphone must be connected.
8. Follow the instructions in the app.
9. Touch the  symbol to continue.
"Connect to app" appears.
10. Touch the  symbol.
"Add mobile device" appears.
11. Touch the  symbol to confirm.
Follow the instructions in the app.

If the display shows "Network connection successful", the connection process is complete. Follow the instructions in the app.

Home Connect settings

Home Connect can be adapted to your specific needs at any time.

Note: You will find the Home Connect settings in the basic settings for your appliance. Which settings the display shows will depend on whether Home Connect has been set up and whether the appliance is connected to your home network.

	Basic setting	Possible settings	Explanation
	Connection type	LAN/WLAN	<p>You can switch between connection types (LAN cable and WLAN).</p> <p>Follow the instructions for setting up the relevant connection type. → <i>"Setting Up" on page 26</i></p>
	Connecting	Connect/disconnect	<p>Switch the network connection on or off as required (e.g. for holiday).</p> <p>Network information is retained after the appliance is switched off. After switching on the appliance, you will need to wait for a few seconds while it reconnects to the network.</p> <p>In networked standby mode, the appliance requires max. 2 W.</p>
	Connect to app		Start the connection process between the app and the appliance.
	Software update		As soon as a new software version is available, a message appears in the display. You can install the new software in the Home Connect menu ↓.
	Remote start	Activate/deactivate	<p>Access the appliance's functions via the Home Connect app.</p> <p>When activated, the dispensing of drinks can be started via the app.</p> <p>When deactivated, only the appliance's operating statuses will be displayed in the app.</p>
	Delete network settings		All network settings can be deleted from the appliance at any time.
	Appliance information		<p>The display shows:</p> <ul style="list-style-type: none"> • MAC address COM module • Serial number of the appliance • Software version <p>You can view more information – such as the SSID (network name), although this depends on the connection type – by touching the arrow button.</p>

Remote Start

Remote start must be activated in order to start and operate your appliance via the Home Connect app. If remote start is deactivated, only the operating modes of the appliance can be displayed in the Home Connect app and the appliance settings configured.

WARNING

Risk of scalding (Home Connect)!

If an unattended remote start takes place, third parties might be scalded if they reach under the coffee dispenser during drinks dispensing. You should therefore make sure that with an unattended remote start there is no risk to other people, in particular not to children, or to property.

Remote Diagnostics

Customer Service can use Remote Diagnostics to access your appliance if you contact them, have your appliance connected to the Home Connect server and if Remote Diagnostics is available in the country in which you are using the appliance

Note: For further information and details about the availability of Remote Diagnostics in your country, please visit the Service/Support section of your local website: www.home-connect.com

Information on Data Protection

When your appliance is connected to a WLAN network that is connected to the Internet for the first time, your appliance transmits the following categories of data to the Home Connect server (initial registration):

- Unique appliance identification (consisting of appliance codes as well as the MAC address of the installed Wi-Fi communication module).
- Security certificate of the Wi-Fi communication module (to ensure a secure data connection).
- The current software and hardware version of your appliance.
- Status of any previous resetting to factory settings.

This initial registration prepares the Home Connect functions for use and is only required when you want to use these Home Connect functions for the first time.

Note: Ensure that the Home Connect functions can be used only in conjunction with the Home Connect app. Information on data protection can be accessed in the Home Connect app.

Declaration of Conformity

Gaggenau Hausgeräte GmbH hereby declares that the appliance with Home Connect functionality meets the basic requirements and other relevant provisions of Directive 2014/53/EU.

A detailed RED Declaration of Conformity can be found online at www.gaggenau.com among the additional documents on the product page for your appliance.



2.4 GHz band: max. 100 mW
5 GHz band: max. 100 mW



BE	BG	CZ	DK	DE	EE	IE	EL
ES	FR	HR	IT	CY	LV	LT	LU
HU	MT	NL	AT	PL	PT	RO	SI
SK	FI	SE	UK	NO	CH	TR	

5 GHz WLAN (Wi-Fi): For indoor use only

Wi-Fi® Module

FCC/IC Statements

Model: COM2
FCC ID: 2AHES-COM2
IC ID: 21152-COM2

The Home Connect module is a communication device designed to provide communication between appliances and smart devices.

This module is integrated at the factory, under direct control of BSH Home Appliances Corporation, and is not user servicable or upgradable.

FCC COMPLIANCE STATEMENT

CAUTION

Changes or modifications not expressly approved could void your authority to use this equipment.

This device complies with Part 15 of the FCC Rules. Operation to the following two conditions:

1. This device may not cause harmful interference, and
2. This device must accept any interference received, including interference that may cause undesired operation.

INDUSTRY CANADA STATEMENT

This device complies with Industry Canada license-exempt RSS standard(s).

Operation is subject to the following two conditions:

1. This device may not cause interference, and
2. This device must accept any interference, including interference that may cause undesired operation of the device.

Daily care and cleaning

Daily care

Every time the appliance is switched on or switched to **0**, it rinses automatically. Exception: The appliance was only switched off a few minutes beforehand or no coffee beverage was dispensed before it was switched to **0**.

WARNING

Risk of electric shock!

Before cleaning the appliance, switch it off using the main switch. Never immerse the appliance in water. Do not use a steam cleaner.

CAUTION

Surface damage!

- Do not use any cleaning agents containing alcohol or spirits.
- Do not use abrasive cloths or cleaning agents.
- Always remove any residues of limescale, coffee, milk and descaling solution immediately. This residue may cause corrosion to form.
- New sponge cloths may contain salts. Salts can cause rust film on stainless steel and must therefore always be washed out thoroughly before use.

Notes

- The drip tray and coffee residue container should be emptied and cleaned every day in order to prevent deposits.
- Clean the drip tray with the filter regularly.
- Immediately remove residues from the shelf to avoid stains.
- If the appliance has not been used for a prolonged period of time (e.g. while you are on holiday), clean the entire appliance thoroughly, including the milk system, ground coffee drawer and brewing unit before using.

1. Wipe the housing with a soft, damp cloth.
2. Remove the shelf, open the door and pull out the drip tray to the front.
3. Press down the lever in the drip tray and pull out the drip tray forwards.
4. Remove the filter from the drip tray.
5. Empty, clean and dry individual parts.
6. Rinse out the water tank with clear, fresh water.

7. Remove the ground coffee drawer, clean it under running water and dry it thoroughly.
8. Wipe out the inside of the appliance (drip tray holder and ground coffee drawer) and the collecting tray and dry them.
9. Insert the filter in the drip tray and snap into place.
10. Insert the dry parts, such as the ground coffee drawer.

CAUTION

Not all of the appliance's components can be cleaned in the dishwasher.

Not dishwasher-safe:



Shelf
 Accessory drawer
 Water tank with lid
 Beverage dispenser cover
 Metallic connecting element
 Bean container with lid
 Ground coffee drawer
 Protective cover for brewing unit
 Brewing unit
 Milk container

Dishwasher- safe:



Collecting tray
 Drip tray
 Coffee residue container
 Max. 140 °F (Max. 60 °C) Milk hoses
 Milk tube
 Individual parts of the beverage dispenser
 Measuring spoon
 Individual parts of the milk container lid
 Shelf for the milk container

Cleaning the milk system

The milk system is automatically cleaned with a short jet of steam directly after preparing a milky beverage.

Important: Clean the milk system manually on a weekly basis, or more frequently if required. → "Cleaning the milk system manually" on page 31

WARNING

Risk of burns!

The beverage dispenser gets very hot. After use, always let it cool down before you touch it.

Cleaning the milk system automatically

1. Rotate function selector to **S**.
2. Use the rotary selector to select "Clean milk frothing system".
3. Touch the ✓ symbol.
The cleaning program starts. The notes on the display guide you through the program.
4. Open the door.
5. Remove the milk tube from the milk container, wipe it down and insert the end of the milk tube into the hole on the coffee residue container.

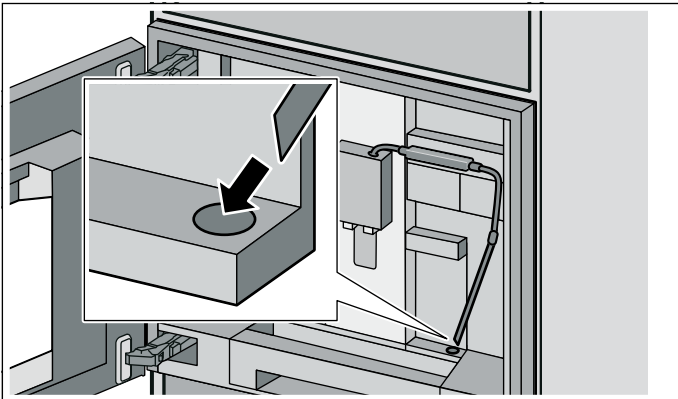

6. Close the door.
7. Touch the ► symbol.
The program runs for approx. 1 minute.
8. Touch the ✓ symbol.
The program has finished.

Cleaning the milk system manually

Take the milk system apart to clean it:

1. Push the beverage dispenser down completely and pull the cover forward to remove.
2. Press the snap lever to the left of the beverage dispenser downwards and pull the beverage dispenser straight forwards.

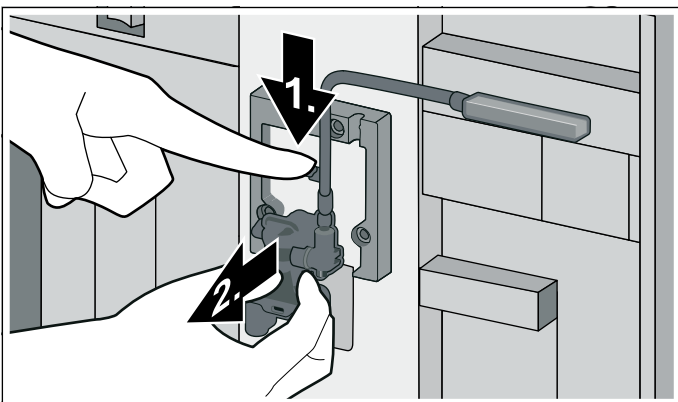

3. Detach the milk hose, dismantle the top and bottom sections of the beverage dispenser.

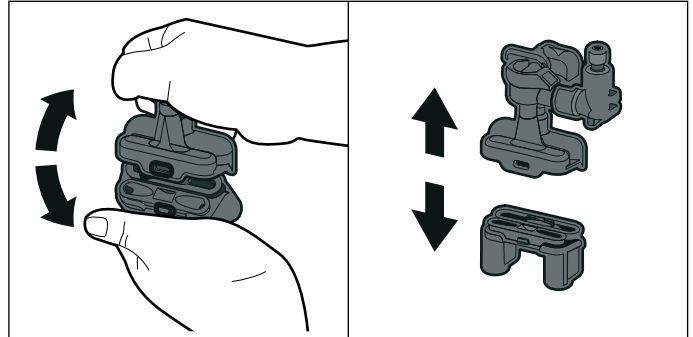

4. Separate the milk hoses, connecting element and milk tube.

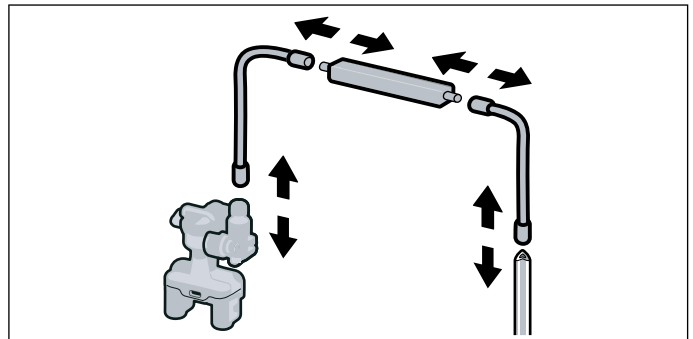

5. Clean the individual parts with a detergent solution and a soft cloth.
6. Rinse all parts with clean water and dry.
7. Put the individual parts back together again (see also quick reference guide).

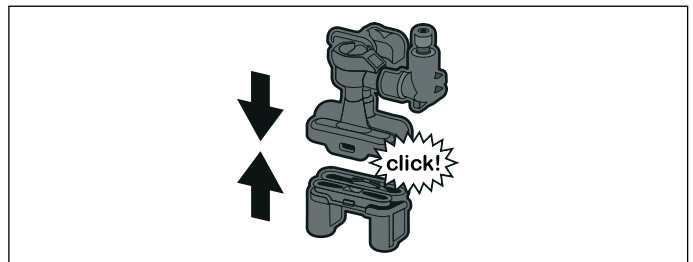

8. Firmly attach the beverage dispenser from the front to the three connections.
9. Replace the cover.

Cleaning the milk container

For reasons of hygiene, the milk container should be cleaned regularly. Only the individual parts of the lid are suitable for dishwasher use. Clean the stainless steel milk container by hand using a gentle cleaning agent.

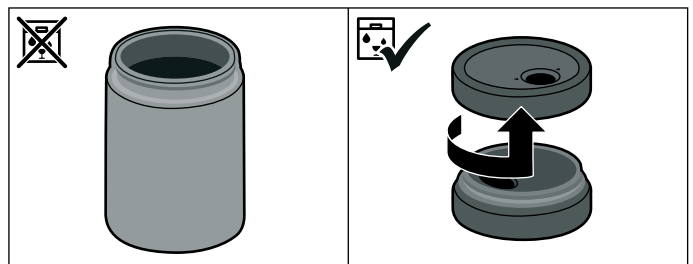

Cleaning the brewing unit

(See also the quick reference guide)

Notes

- Regularly clean the brewing unit by hand in addition to the automatic cleaning program.
- Do not use dishwashing liquid or other cleaning agents to clean the brewing unit and do not put the brewing unit in the dishwasher.

1. Rotate function selector to 0.
2. Open the door.
3. Switch off the appliance using the main switch.
4. Remove the protective cover of the brewing unit.
5. Remove the coffee residue container.
6. Slide the red latch on the brewing unit all the way to the left to .
7. Press the eject lever right down.
The brewing unit will be released.
8. Take hold of the brewing unit by the recessed grips and carefully remove it.
9. Clean the brewing unit thoroughly under running water.

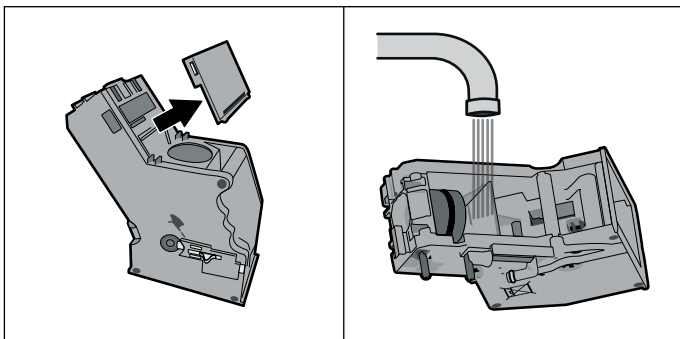

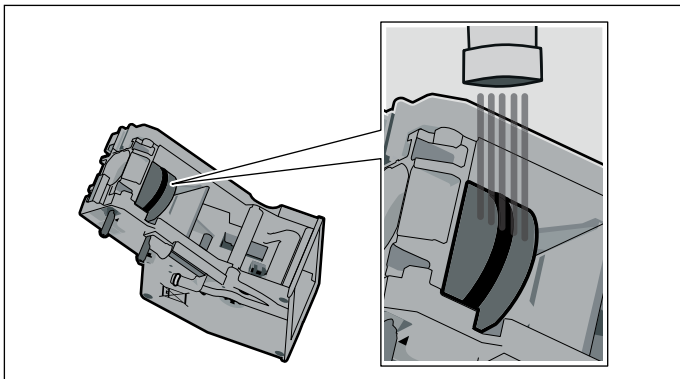

10. Remove the cover and clean the filter under running water.

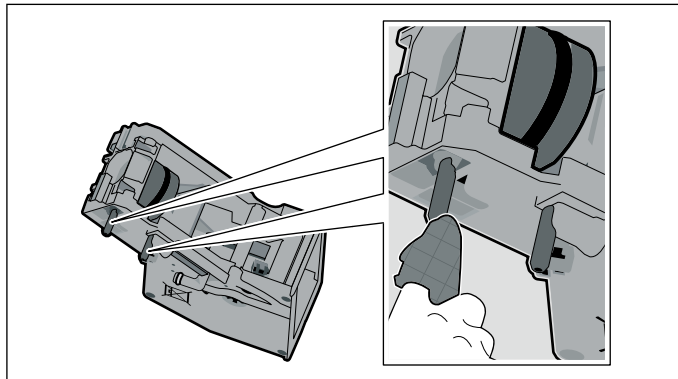

11. Thoroughly clean the connecting taps on the brewing unit.



12. Clean the interior of the appliance thoroughly, taking care to remove any coffee residues.
13. Allow the brewing unit and the interior of the appliance to dry.
14. Refit the cover.
15. Push the brewing unit all the way into the appliance and press on the middle until it audibly clicks into place.
Important: The red latch must be right over at the left in position  before inserting.
16. Press the eject lever all the way up and push the red latch right over to the right to .
17. Insert the coffee residue container.
18. Replace the protective cover.
19. Close the door.

Service programs

(See also the quick reference guide)

Every so often – the exact frequency depends on usage and water hardness – one of the following messages will appear on the display in place of the coffee selection:

- Please change water filter
- Please clean
- Please descale
- Please clean and descale

Then the **i**[®] warning symbol lights up.

The water filter should be changed immediately at this point and the appliance cleaned or descaled using the appropriate program. Otherwise the appliance may be damaged.

You can also start the service programs at any time without having to wait for a reminder to appear on the display. Set the function selector to **S**, and select and run the desired program.

Notes

- **Caution!** Do not drink or come into contact with cleaning or descaling materials. Keep cleaning materials and descaling tablets out of the reach of children. They may be toxic.
- **Important:** If the appliance is not descaled when it is supposed to be, the message "Appliance locked Descaling required urgently" will appear. Immediately perform the descaling process in accordance with the instructions. If the appliance is locked, it can only be operated again once the descaling process has been carried out.
- **Warning!** For each of the service programs, use descaling and cleaning agents as described in the instructions and observe the (relevant) safety information.
 - Do not drink the liquids.
 - Never use citric acid, vinegar or any vinegar- based agents to descale the appliance.
 - For cleaning and descaling, only use the tablets intended for this purpose. The tablets were specially developed for this appliance and new stocks can be ordered through our customer service.
→ "Accessories" on page 12
 - Never insert descaling tablets or other agents into the grounds compartment.
 - Never interrupt the service program.
 - Prior to starting a service program, remove, clean and reinsert the brewing unit. Rinse the milk system.
 - At the end of a service program, wipe down the appliance using a soft, damp cloth to immediately remove any residue of the descaling solution. This residue may cause corrosion to form.
 - New sponge cloths may contain salts. Salts can cause rust film on stainless steel and must therefore be washed out thoroughly before use.
 - If one of the service programs is interrupted, e.g. by a power outage, proceed as follows:
 1. Touch the ✓ symbol.
 2. Remove the milk tube from the milk container and wipe it down. Insert the end of the milk tube into the hole in the coffee residue container.
 3. Touch the ▶ symbol.
The programme starts and rinses the appliance. Duration: approx. 2 minutes.
 4. Touch the ✓ symbol.
- **Caution!** Do not drink the descale solution.

Using a water filter increases the intervals until a descaling program needs to be performed.

Cleaning

Duration: approx. 5 minutes

Clean the brewing unit before the start of the service program. → "Cleaning the brewing unit" on page 32

1. Rotate function selector to **S**.
2. Select "Cleaning program" using the rotary selector.
3. Touch the ✓ symbol.

The cleaning program starts. The notes on the display guide you through the program.

4. Empty the drip tray with the filter and the coffee residue container. Clean and reinsert.
5. Place a cleaning tablet into the ground coffee drawer and close the drawer again.
6. Close the door.
7. Touch the ▶ symbol.

The program will run for approx. 5 minutes.

8. Touch the ✓ symbol.

The cleaning program is complete.

The appliance is ready for use.

Descaling

Duration: approx. 21 minutes

1. Rotate function selector to **S**.
2. Select "Descaling program" using the rotary selector.
3. Touch the ✓ symbol.

The descaling program starts. The notes on the display guide you through the program.

4. Empty the drip tray with the filter and the coffee residue container. Clean and reinsert.
5. Remove the water filter (if there is one) and touch the ✓ symbol.
6. Pour lukewarm water into the empty water tank up to the "calc" mark (17 oz/0.5 l) and then dissolve a descaling tablet in it.
7. Remove the milk tube from the milk container, wipe it down and insert the end of the milk tube into the hole on the coffee residue container.

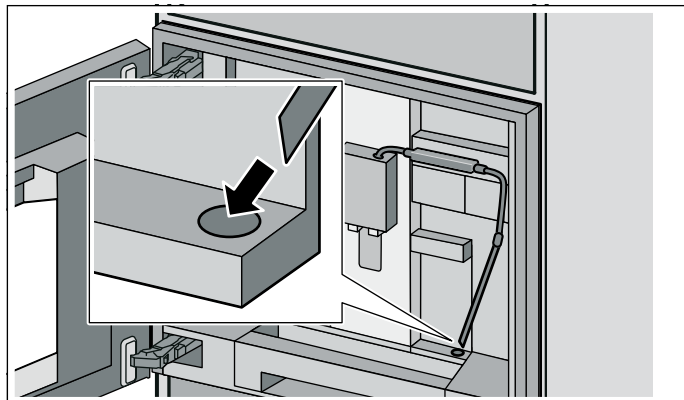

8. Close the door.
9. Touch the ▶ symbol.

The program will run for approx. 19 minutes.

Note: If there is too little descaling solution in the water tank, the message "Fill water tank with water and descaler" appears. Fill the empty water tank with lukewarm water up to the "calc" mark (17 oz/0.5 l) and then dissolve a descaling tablet in it. Press ✓ to confirm. The program will continue.

10. If a water filter is used, reinsert it now.
11. Touch the ▶ symbol.

The program will run for approx. 2 minutes and rinse the appliance.

The program has finished.

12. Touch the ✓ symbol.

The appliance is ready to use.

Cleaning and descaling

Duration: approx. 26 minutes

The cleaning and descaling program combines the individual cleaning and descaling functions. If the two programs are due at about the same time, your fully automatic espresso machine will automatically suggest running this combined service program.

Clean the brewing unit before the start of the service program. → "Cleaning the brewing unit" on page 32

1. Rotate function selector to **S**.
2. Select "Cleaning and descaling program" using the rotary selector.
3. Touch the ✓ symbol.
The cleaning and descaling program starts. The notes on the display guide you through the program.
4. Empty the drip tray with the filter and the coffee residue container. Clean and reinsert.
5. Place a cleaning tablet into the ground coffee drawer and close the drawer again.
6. Remove the water filter (if there is one) and touch the ✓ symbol.
7. Pour lukewarm water into the empty water tank up to the "calc" mark (17 oz/0.5 l) and then dissolve a descaling tablet in it.

- Remove the milk tube from the milk container, wipe it down and insert the end of the milk tube into the hole on the coffee residue container.

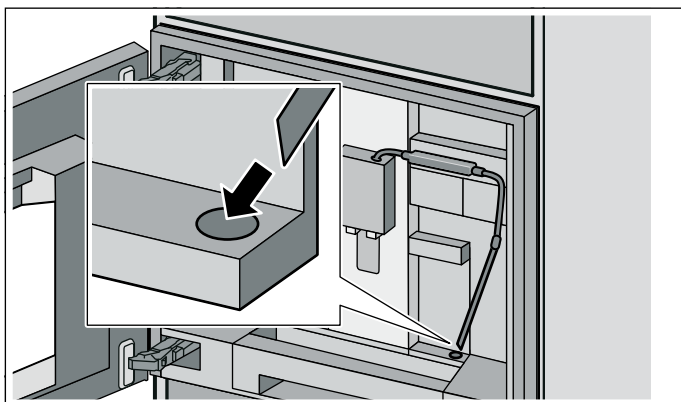

- Close the door.
- Touch the ► symbol.

The program will run for approx. 19 minutes.

Note: If there is too little descaling solution in the water tank, the message "Fill water tank with water and descaler" appears. Fill the empty water tank with lukewarm water up to the "calc" mark (17 oz/0.5 l) and then dissolve a descaling tablet in it. Press ✓ to confirm. The program will continue.

- If a water filter is used, reinsert it now.
- Touch the ► symbol.

The program will run for approx. 7 minutes and rinse the appliance.

The program has finished.

- Touch the ✓ symbol.

The appliance is ready to use.

Fill the water tank with fresh water

If the appliance is not used for a few days, the water in the water tank should be replaced. The appliance must be ready for use.

- Rotate function selector to **S**.
- Select "Fresh water replenishment" using the rotary selector.
- Touch the ✓ symbol.
- Touch the ► symbol.

The tank is emptied and filled with fresh water. Fresh water replenishment has finished.

- Touch the ✓ symbol.

The appliance is ready for use.

Emptying program

The emptying program is a service program which is used to remove coffee bean residue and to prevent damage caused by frost during transportation and storage. The appliance must be ready for use.

- Rotate function selector to **S**.
- Select "Emptying program" with the rotary selector.
- Touch the ✓ symbol.
- Empty the bean container and reinsert it.
- If present, remove the milk container.
- Close the door.

The emptying program runs for approx. 2 minute.

- Remove the brewing unit and clean it thoroughly.
- Clean the drip tray, coffee residue container, milk system and milk hose set thoroughly, then reinsert them.
- Close the door.
- Touch the ✓ symbol.

The emptying program is finished.

AQUA-STOP pledge

In addition to the standard warranty provided by BSH, BSH will also compensate customers for damage caused by a specific fault in the Aqua-Stop system giving rise to a valid warranty claim. Compensation will be provided under the following conditions:

1. If water damage is caused by defect in materials or workmanship in the Aqua-Stop system, BSH will compensate customers reasonable and verifiable damages.
2. A condition of all warranty claims is the appliance with Aqua-Stop must have been installed and connected correctly in accordance with all instructions; this also includes a properly installed Aqua-Stop extension (genuine accessories). The warranty does not cover defective feed lines or fittings leading to the Aqua-Stop connection at the tap.

Technical specifications

Power connection with transformer type 8001010566 (voltage - frequency)	120 V AC - 60 Hz
Power rating	1600 W
Maximum static pump pressure	19 bar
Maximum water tank capacity (without filter)	81.15 oz (2.4 l)
Maximum capacity of the coffee bean container	17.64 oz (500 g)
Length of power cable (Power socket - transformer)	39" (1 m)
Dimensions (appliance without transformer) H x W x D	17.91 x 23.23 x 17.48" (455 x 590 x 444 mm)
Weight, empty (appliance without transformer)	46 - 49 lb (21 - 22 kg)
Type of grinding unit	Ceramic

Simple troubleshooting

Problem	Cause	Remedial action
The personally selected capacity is not reached. Coffee dispensing slows to a trickle or stops completely.	The grinding level is too fine. The ground coffee is too fine.	Adjust the grinding level to a coarser setting. Use coarser ground coffee.
	The appliance is heavily calcified.	Descalcify the appliance as described in the instructions. → <i>"Service programs" on page 33</i>
	The brewing unit is soiled.	Clean the brewing unit. → <i>"Cleaning the brewing unit" on page 32</i>
The hot water is milky or tastes of milk or coffee.	The milk hose has not been removed.	Remove the milk hose from the milk container.
	Milk or coffee residue in the beverage dispenser.	Clean the beverage dispenser.
The coffee has no crema.	Unsuitable type of coffee.	Use a type of coffee with a higher proportion of robusta beans.
	The beans are no longer freshly roasted.	Use fresh beans.
	The grinding level was not suitable for the coffee beans.	Set a finer grinding level.
The coffee is too "acidic".	The grinding level is too coarse. The ground coffee is too coarse.	Adjust the grinding level to a finer setting. Use finer ground coffee.
	Unsuitable type of coffee.	Change the type of coffee.
The coffee is too bitter.	The grinding level is too fine. The ground coffee is too fine.	Adjust the grinding level to a coarser setting. Use coarser ground coffee.
	Unsuitable type of coffee.	Change the type of coffee.
The coffee tastes burnt.	The brewing temperature is too high.	Reduce the temperature. → <i>"Preparing beverages" on page 16</i>
	The grinding level is too fine. The ground coffee is too fine.	Adjust the grinding level to a coarser setting. Use coarser ground coffee.
	Unsuitable type of coffee.	Change the type of coffee.
The coffee is too weak.	Coffee strength selected is too weak.	Use stronger coffee. → <i>"Preparing beverages" on page 16</i>
	Ground coffee drawer blocked with ground coffee.	Remove the ground coffee drawer, clean and dry it thoroughly.
The quality of the milk foam varies.	The quality of the milk froth depends on the type of milk or the plant-based alternative used.	Optimise the result by selecting your milk or plant-based alternative as appropriate.
The ground coffee gets stuck in the ground coffee drawer.	The ground coffee sticks together.	Do not compact the ground coffee in the ground coffee drawer.
	The ground coffee drawer is damp.	Remove the ground coffee drawer, clean and dry it thoroughly.
The water filter does not stay in position in the water tank.	The water filter is not fitted correctly.	Firmly press the water filter straight down into the tank connection.
The bean container sticks when inserted.	There are beans in the housing.	Remove beans.
The coffee residue are not compact and are too wet.	The grinding level is set too fine or coarse, or not enough ground coffee has been used.	Set a coarser or finer grinding level or use 2 level measuring spoons of ground coffee.

Problem	Cause	Remedial action
The grinding level adjustment is stiff.	Too many beans in the grinding unit.	Dispense a beverage made from coffee beans. Only make any subsequent changes to the grinding level in small steps.
The brewing unit cannot be inserted.	Brewing unit in the wrong position.	Insert the brewing unit as described in the instructions. → <i>"Cleaning the brewing unit" on page 32</i>
	Brewing unit is locked.	Unlock brewing unit. → <i>"Cleaning the brewing unit" on page 32</i>
The protective cover of the brewing unit cannot be properly attached.	Brewing unit is not locked.	Lock the brewing unit. → <i>"Cleaning the brewing unit" on page 32</i>
There is water under the drip tray.	This is condensation.	Do not insert the drip tray without the cover.
Display screen "Milk container connected?" despite connected milk container.	Container is outside the range of the sensor.	Position the container at the right edge
	Material, e.g. milk carton, is not recognized.	Confirm the display query with "Yes" or use the supplied milk container.
No milk dispensed despite filled milk container.	The milk tube is not inserted deep enough in the milk container.	Insert the milk tube down to the bottom of the milk container.
The milk container is empty, but no message is displayed.	The shelf (scales) for the milk container is soiled.	Remove shelf. Clean the shelf and the area underneath thoroughly.
Display screen "High or low voltage".	Voltage is too high or too low.	Contact electricity or grid provider. Have the power supply checked by an expert.
Display screen "Let appliance cool down".	Appliance is too hot.	Switch off appliance for 30 minutes.
Display screen "Error: E0510".	The appliance has encountered an error.	Proceed according to the display screen.
Display screen shows "Fill coffee beans". The appliance does not grind the beans despite filled bean container.	Beans do not drop into the grinding unit (beans that are too oily may stick to the bean container).	Gently tap the bean container. Possibly change the type of coffee. When the bean container is empty, wipe it with a dry cloth.
Display screen shows "Remove brewing unit and clean by hand".	Brewing unit soiled.	Clean the brewing unit.
	Too much ground coffee in the brewing unit.	Clean the brewing unit. Add no more than two level measuring spoons of ground coffee.
	The brewing unit mechanism is stiff.	Clean the brewing unit. → <i>"Cleaning the brewing unit" on page 32</i>
Display screen "Refill with still water or remove filter".	Water tank wrongly inserted.	Insert water tank correctly.
	Carbonated water in the water tank.	Fill the water tank with fresh tap water.
	Float is stuck in the water tank.	Remove the tank and clean thoroughly.
	New water filter not rinsed according to instructions, or water filter spent or defective.	Rinse the water filter according to the instructions and then switch on, or use a new water filter.
	Air in the water filter.	Immerse the water filter in water until no more air bubbles escape; insert the filter again.

Problem	Cause	Remedial action
Display screen "Clean trays and replace"	Drip tray and filter are soiled.	Clean and dry the drip tray and filter thoroughly.
	Outlet in the drip tray is blocked.	Thoroughly clean outlet.
	The siphon is blocked.	Thoroughly clean siphon.
Display screen "Insert trays" despite being inserted.	Inside of appliance (tray holder) soiled.	Clean the inside.
	The coffee residue container was not fully inserted.	Push the coffee residue container all the way in.
Very frequent display that descaling is necessary.	Water is too hard.	Insert water filter and configure settings accordingly in the menu.
The water tank is not filled automatically.	Float is stuck in the water tank.	Remove the tank and clean thoroughly.
	Tap is turned off.	Turn on the tap.
	The water tank is not inserted correctly.	Insert the water tank to the stop.
	Filter on AquaStop blocked.	Clean the filter on the Aqua-Stop regularly. See installation instructions.
Display screen "Switch off appliance"	Appliance is too warm.	Let the appliance cool down.
	Brewing unit soiled.	Clean the brewing unit.
Display screen "Contact customer service".	The appliance has encountered an error.	Please contact the hotline.
Display screen "Communication module not detected Connection not possible".	Technical fault.	Switch the appliance off and on at the main switch.
Home Connect is not working correctly.		Go to www.home-connect.com
Display screen "Connection to home network interrupted".	Router is switched off or LAN cable not connected.	Switch on router or connect LAN cable.
Display screen "Connection to server interrupted".	Technical problem.	Only operate within the home network.
If you are unable to solve the problem, always call the hotline.		

BSH Home Appliances Corporation
1901 Main Street, Suite 600
Irvine, CA 92614
USA
www.gaggenau.com
1-877-442-4436
© 2021 BSH Home Appliances Corporation

GAGGENAU



8001269055 en-us (020912)